



Zimmer®  
Periarticular  
Proximal Tibial  
Locking Plate

Surgical Technique





## Table of Contents

<b>Introduction</b>	<b>2</b>
Locking Screw Technology	2
Locking Plate Technology	2
Plate Features	3
Fracture Classification	3
<b>Surgical Technique</b> <b>for the Periarticular 5.5mm Proximal Tibial Locking Plate</b>	<b>4</b>
Required Instrumentation	4
Preoperative Preparation	4
Surgical Approach	4
Fracture Reduction	6
Plate Positioning	6
Screw Trajectory	9
Fracture Fixation	9
Wound Closure	16
Postoperative Treatment	16
Implant Removal	16
Instruments and Implants	17
Order Information	20
<b>Surgical Technique</b> <b>for the Periarticular 3.5mm Proximal Tibial Locking Plate</b>	<b>21</b>
Required Instrumentation	21
Preoperative Preparation	21
Surgical Approach	21
Fracture Reduction	22
Plate Positioning	22
Screw Trajectory	24
Fracture Fixation	25
Wound Closure	30
Postoperative Treatment	30
Implant Removal	30
Instruments and Implants	31
Order Information	34

## Introduction

The *Zimmer* Periarticular Locking Plate System combines locking screw technology with periarticular plates to create fixed-angle constructs for use in comminuted fractures or where deficient bone stock or poor bone quality is encountered. The fixed-angle plate/screw device can be used in osteopenic bone and other areas where traditional screw fixation may be compromised.

The Periarticular Locking Plates will accommodate standard screws, as well as locking screws with threaded heads. When necessary, interfragmentary compression can be achieved using standard screws in the dual compression slots.

Cannulated screws and instruments allow provisional fixation with guide pins in the metaphysis. This helps ensure that the threaded locking screw heads align properly with the threaded plate holes.

All plate configurations contain locking screw holes in the plate head, and alternating locking and compression screw slots in the shaft.

### Locking Screw Technology

The heads of the locking screws contain male threads while the holes in the plates contain female threads. This allows the screw head to be threaded into the plate hole, locking the screw into the plate. This technical innovation provides the ability to create a fixed-angle construct while using familiar plating techniques.

### Locking Plate Technology

By using locking screws in a bone plate, a fixed-angle construct is created. In osteopenic bone or fractures with multiple fragments, secure bone purchase with conventional screws may be compromised. The locking screws do not rely on bone/plate compression to resist patient load, but function similarly to multiple small angled blade plates. In osteopenic bone or comminuted fractures, the ability to lock screws into a fixed-angle construct is imperative.

By combining locking screw holes with compression screw slots in the shaft, the plate can be used as both a locking device and a fracture compression device. If compression is desired, it must be achieved first by inserting the standard screws in the compression screw slots before inserting any locking screws.

The locking plate design does not require compression between the plate and bone to accommodate loading. Therefore, purchase of the screws in the bone can be achieved with a thread profile that is shallower than that of traditional screws. The shallow thread profile, in turn, allows for screws with a large core diameter to accommodate loading with improved bending and shear strength.

### Plate Features

- Anatomically contoured plates are precontoured to create a fit that requires little or no additional bending and helps with metaphyseal/diaphyseal reduction
- The low profile plate facilitates fixation without impinging on soft tissue
- The plate can be used to control a medial fracture fragment
- 3.5mm Proximal Lateral Tibial Locking Plates are available in six lengths, from 6 hole (104mm ) to 16 hole (224mm)
- 5.5mm Proximal Lateral Tibial Locking Plates are available in six lengths, from 4 hole (97mm ) to 14 hole (250mm)
- Dual compression slots will accommodate periarticular screws or conventional stainless steel screws and allow bi-directional compression
- The last diaphyseal plate hole is designed to accommodate the tension device (00-4817-005-00)

### Additional Implant Options

The following implant sets and part numbers are optional implants to be used with this plating system:

- Zimmer® MotionLoc® Screw for Periarticular Locking Plate System (ST-2359-000-09)
  - 3.5mm Peri Locking Cable Button, Stainless Steel (47-2232-060-35)
  - 2.5mm Hex Button, Stainless Steel (00-2232-001-25)
  - 1.3mm x 762mm Cable Assembly, Stainless Steel (00-2232-011-13)
  - 5.5mm Peri Locking Cable Button, Stainless Steel (47-2232-060-55)
  - 5.0mm Hex Button, Stainless Steel (00-2232-001-50)
  - 1.8mm x 559mm Cable Assembly, Stainless Steel (00-2232-001-18)
  - 1.8mm x 914mm Cable Assembly, Stainless Steel (00-2232-001-28)
- Fracture Classification

### Fracture Classification

Refer to the OTA Fracture and Dislocation Compendium, or the Schatzker classification below for more information.

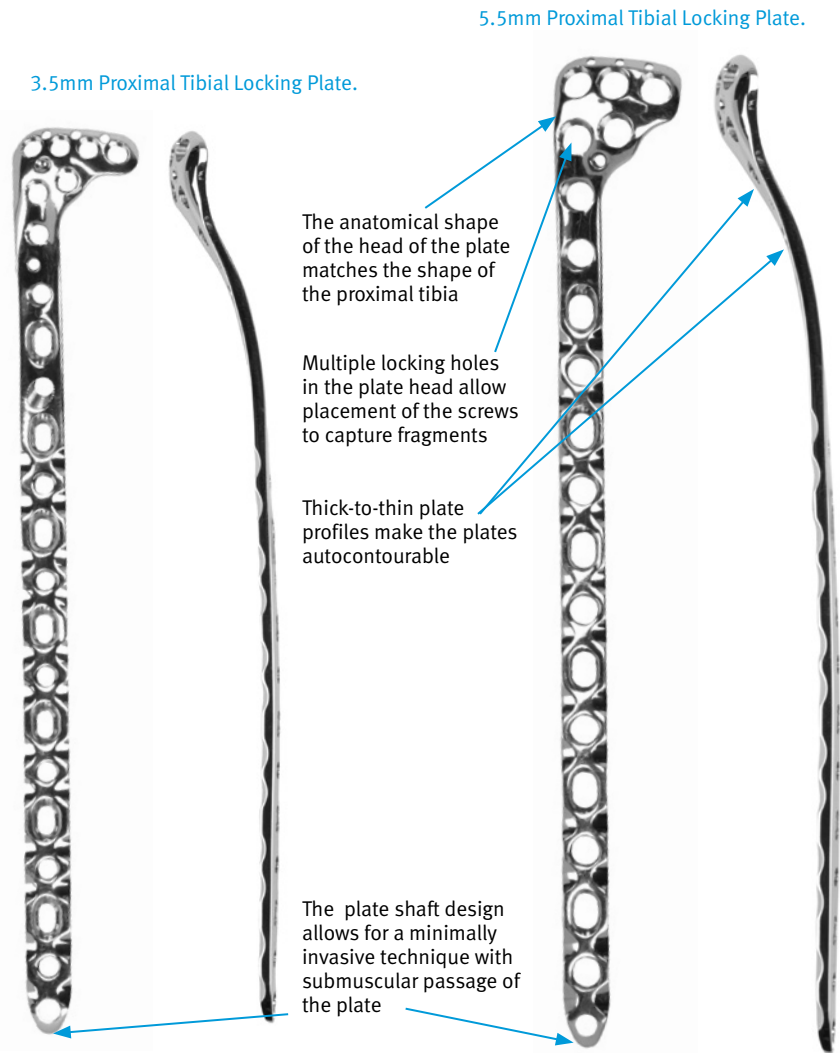
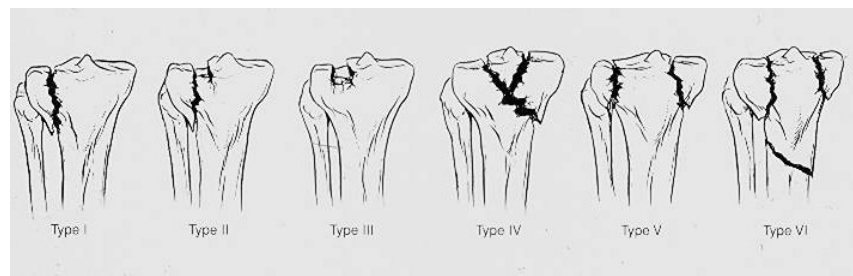

Fig. 1. Zimmer Periarticular Proximal Tibial Locking Plate features.



## Surgical Technique for the Periarticular 5.5mm Proximal Tibial Locking Plate

### Required Instrumentation

The following sets may be required for application of the 5.5mm Periarticular Locking Proximal Tibia Plates:

- Standard Screw Set
- Basic Instrument Set
- Basic Forcep Set
- 5.5mm/4.5mm Locking Screw and Instrument Set
- 5.5mm Locking Proximal Tibia Plate and Standard Jig Set
- Linear Bone Clamps

### Preoperative Preparation

After assessing the fracture radiographically and preparing a preoperative plan, place the patient in the supine position on a radiolucent table. Be sure that the fluoroscope can be positioned to visualize the proximal tibia in both the lateral and Anterior/Posterior (A/P) views.

Pre-operative planning using A/P and M/L templating will allow assessment of the ability of the lateral plate to capture and adequately stabilize any medial fragments. If adequate reduction or fixation is not feasible, a medial buttress plate should also be considered.

### Surgical Approach

The patient is positioned supine on a radiolucent operating table.

A straight lateral parapatellar incision is made (Fig. 2). This incision can be extended proximally and/or distally as more exposure is required.

The dissection should go straight down to the bone by detaching the anterior compartment muscle origins and splitting the fibers of the iliotibial tract. The knee joint is then opened below the lateral meniscus in order to get a good view of the articular surface.

Do not dissect across the tibial tuberosity – unless absolutely necessary – the soft tissue coverage on the medial side is very delicate. Take care not to place incisions over the proposed sites of implants, or where there is risk of devitalizing sensitive structures.

When treating fractures with a bicondylar component, an additional posteromedial incision is recommended to ensure anatomic reduction of the medial cortex (Fig. 3). Use of the linear bone clamps greatly facilitates reduction of this type of fracture (Fig. 4).

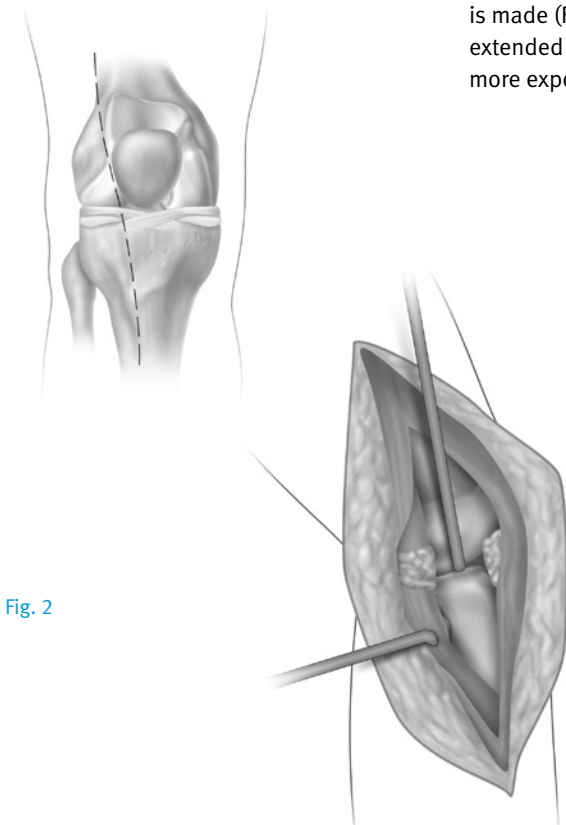

Fig. 2

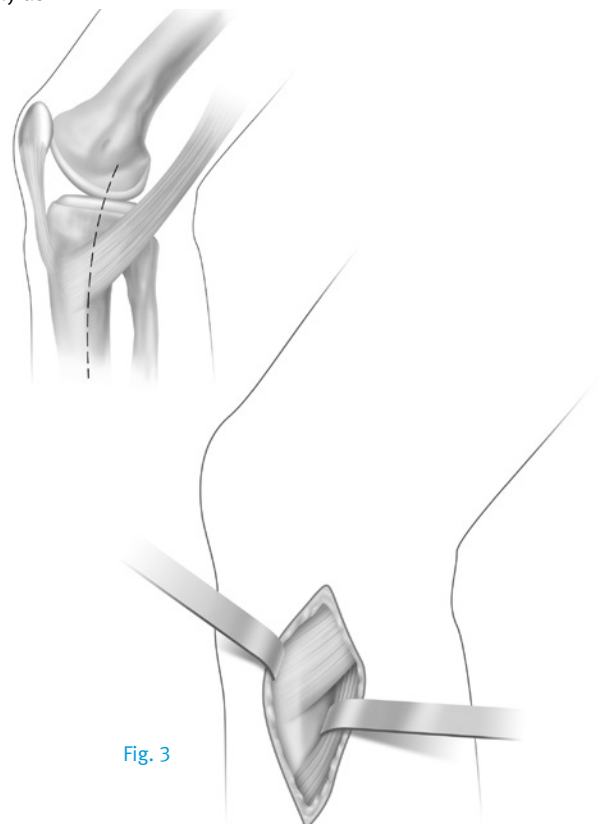
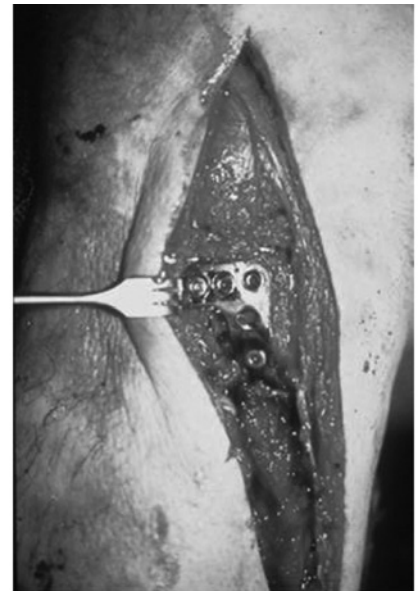
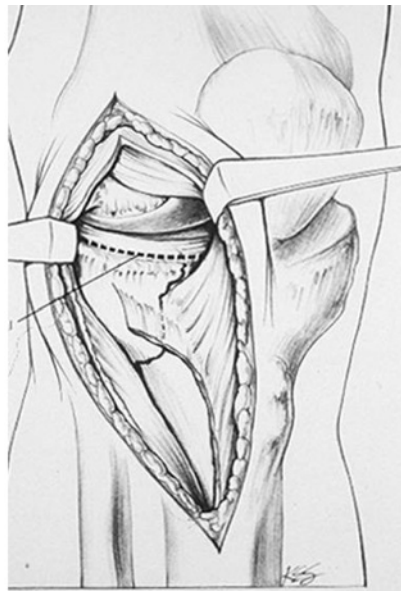
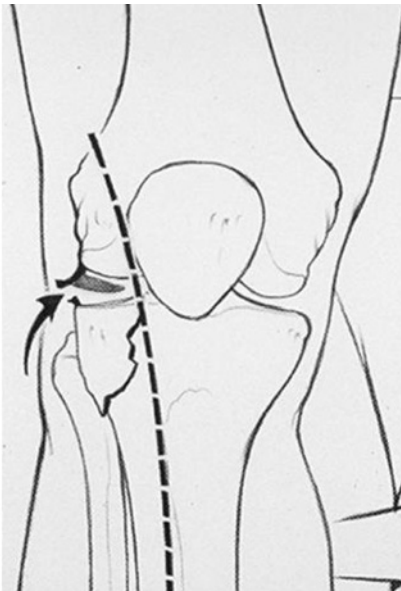

Fig. 3



Fig. 4



**Fracture Reduction**

It is imperative that accurate reduction of the fracture be obtained prior to and maintained during application of the proximal tibial plate.

Reduce the intra-articular fragments using linear bone clamps or Kirschner wires to temporarily hold the reduction. Use lag screws to secure the intra-articular fragments. To help avoid inserting the lag screws where they will interfere with the plate placement, hold the plate on the bone in its approximate position. Then insert the lag screws as needed – the lag screws can often be placed through the plate using cannulated conical screws, or may be inserted in subchondral bone proximal to the plate.

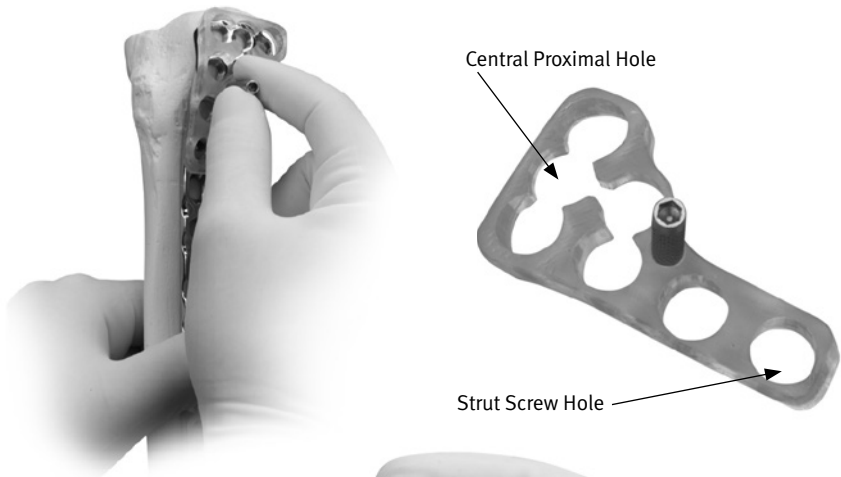

Fig. 5

**Plate Positioning**

Hold the appropriate (left or right) Metaphyseal Jig (Fig. 5) on the selected plate and finger tighten the set screw. Insert the 5.5mm Standard Jig Sleeve into the CENTRAL PROXIMAL hole of the jig (Fig. 6) and thread the 3.2mm Standard Cannula into the plate hole (Fig. 7) through the Jig Sleeve.

Fig. 6

**NOTE: The Cannula Inserter may be used to tighten cannulas.**

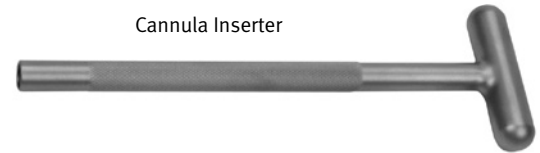
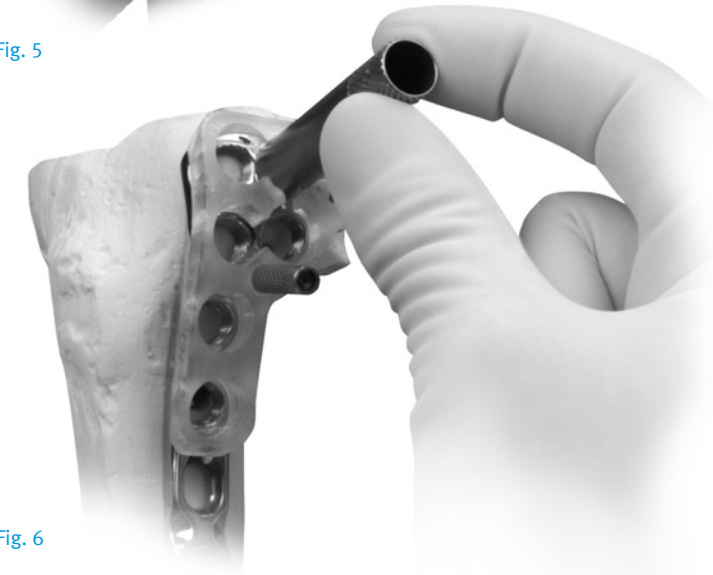

Cannula Inserter



Fig. 7



Before placing the plate on the bone, insert additional 5.5mm Standard Jig Sleeves into each of the most proximal holes in the Metaphyseal Jig, then thread a 3.2mm Standard Cannula into the plate (Fig. 8) through each of the sleeves.

**It is easier to thread the cannulas into the plate holes before the plate is applied to the bone.** The cannulas can be used as handles to position the plate.

Use this construct to place the initial 3.2mm Drill Tip Guide Wire in the metaphysis. Check plate placement – visually and fluoroscopically to ensure that the plate is positioned correctly on the metaphysis of the bone. Use A/P and lateral fluoroscopic images to position the plate. **Note: The position of the plate on the bone must be verified because there is a tendency to place the distal end of the plate too posterior on the tibial shaft. Posterior placement can cause the locking screws to be placed at a tangent and can result in insufficient holding strength.** Because the tibial shaft may not be aligned with the proximal fragment, the plate head should be used to determine the appropriate placement of the plate. The plate head should conform to the shape of the intact or reconstructed proximal tibia. This will determine the alignment of the shaft.

**WARNING: Do not contour or bend the plate at or near a threaded hole, as doing so may deform the threaded hole and cause incompatibility with the locking screw.**

Hold the plate in the desired position (Fig. 9) and insert a 3.2mm Drill Tip Guide Wire through the central Guide Wire Cannula in the head of the plate until the tip engages the opposite cortical wall. Use the fluoroscope to confirm the position of the wire in both the A/P and lateral planes. Adjust the wire location if necessary. If preferred, use a linear bone clamp or bone reduction instrument to secure the plate.

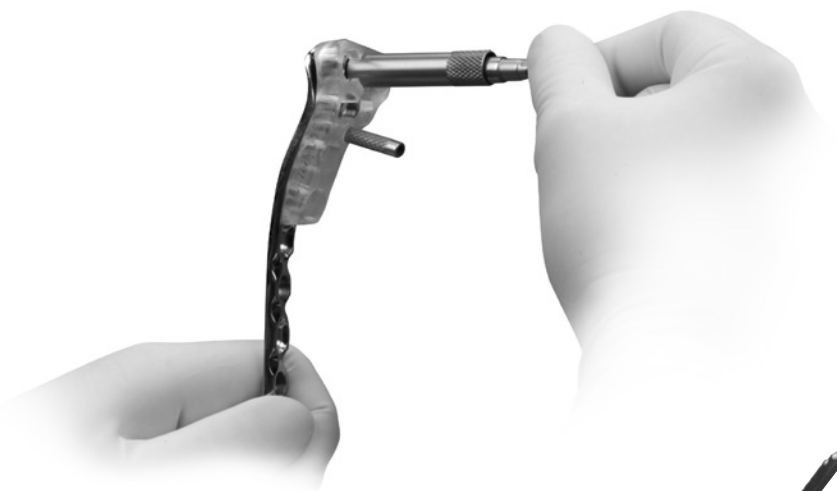

Fig. 8



Fig. 9

When the first wire is satisfactory, adjust the plate rotation, if necessary. The next step is to align the plate shaft with the tibial shaft. Insert a 3.7mm cannula into the most distal plate shaft hole. Use the 3.7mm drill bit through the cannula. Make certain under A/P and lateral fluoroscopy that the plate shaft and tibial shaft are aligned properly. Measure for the 4.5mm locking screw length using the 5.5mm/4.5mm standard locking screw depth gauge. Insert the 4.5mm locking screw. Then insert additional 3.2mm Drill Tip Guide Wires (Fig. 10) through the other proximal Guide Wire Cannulas to help prevent rotation of the plate.



Fig. 10

**If desired, after removal of the metaphyseal jig, additional 1.6mm Drill Tip Guide Wires can be inserted through the proximal K-wire holes to further stabilize the plate** (Fig. 11). Use the fluoroscope for both A/P and lateral views to confirm the position of the plate head, shaft, and guide wires. The guide wires should be parallel to the joint line.



Fig. 11

## Screw Trajectory

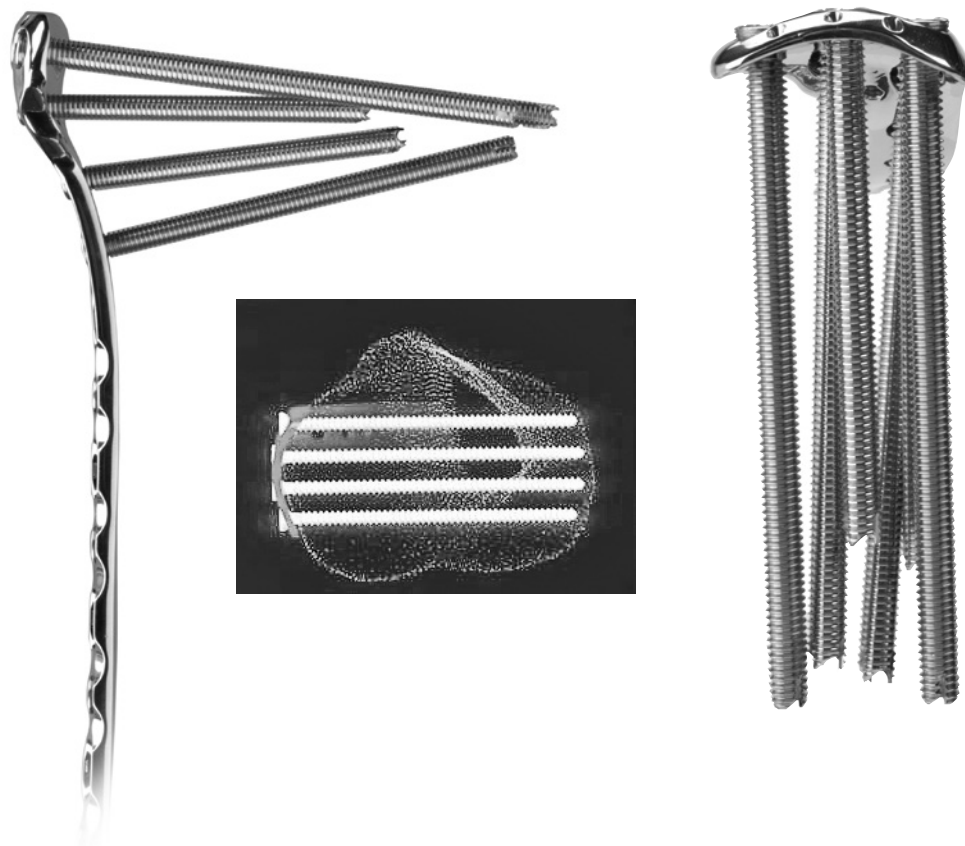

## Fracture Fixation

### Metaphyseal Screw Fixation

Once the plate is properly positioned, slide the 5.5mm Cannulated Screw Depth Gauge (Fig. 12) over the guide wires to measure for the screw lengths. The tip of the gauge must contact the end of the guide wire cannula for an accurate measurement. This will position the tip of the screw at the tip of the guide wire. Read the proper screw length from the guide.

Predrilling and tapping are typically not necessary as the flutes of the screws are self-drilling and self-tapping. If the bone is dense, the lateral cortex can be predrilled using the 4.7mm Cannulated Drill and, if necessary, tapped using the 5.5mm Cannulated Screw Tap.

**NOTE: If required, lag screw reduction of a fragment or compression of the articular surface must be accomplished before inserting any locking screws. The 5.5mm Cannulated Conical Screws can be used for lag screw fixation.**



Fig. 12

Slide the Screwdriver Stop Ring onto the screwdriver shaft and place it at the level of the black ring etched on the driver shaft (Fig. 13). Before the Blue Stop Ring approaches the top of the Jig Sleeve, power insertion should stop. Screws must be seated by hand. The Screwdriver Stop Ring is intended to be a visual cue to stop power insertion of the locking screws.

Remove the Guide Wire Cannulas and use the 5.0mm Hex Cannulated Driver (Fig. 14) to insert a 5.5mm Cannulated Conical or 5.5mm Cannulated Locking Screw over each of the guide wires and into the three proximal holes. Sleeves and cannulas may be inserted into the two additional proximal plate holes if locked screws are necessary in these holes. Follow the same procedure for each proximal screw.

**NOTE: A screwdriver shaft can be used to loosely insert the screw under power, but the final seating must be accomplished by hand to avoid cross-threading of the screws in the plate holes or breakage of the screw or driver.**

**NOTE: Screws inserted into the second row of metaphyseal holes should be less than 80mm in length to avoid interference with the other screws.**

Be sure that all screws are securely tightened.

**NOTE: If the plate shifts during screw insertion, all the pins and screws must be removed and reinserted for the screws to lock properly to the plate.**

**NOTE: If a plate screw impinges on one of the intra-articular lag screws, the lag screw must be removed and repositioned.**



Fig. 13



Fig. 14

Use direct or indirect reduction techniques to reduce the proximal tibia to the shaft. Confirm that the leg is in proper rotation. Temporarily secure the plate shaft to the bone with plate holding forceps, a nonlocking screw or the 5.5mm Plate Reduction Instrument.

If lag screws will be used through some of the holes in the shaft, insert the first lag screw to reduce the plate to the bone.

#### Shaft Fixation

If both locking and nonlocking screws will be used in the shaft, the nonlocking screws must be inserted first. Insert standard cortical screws through the compression slots in the plate as desired.

Apply the appropriate drill guide (Fig. 15) (4.5mm/3.2mm Double Drill Guide, 4.5mm Universal Drill Guide, or 6.5mm/3.2mm Double Drill Guide) to one of the nonlocking slots in the shaft. Use the 3.2mm Standard Drill (Fig. 16) to drill through both cortices.

**NOTE: Use of the 4.5mm Compression Drill Guide [00-4808-045-05] in the Periarticular Proximal Tibial Locking Plate will not generate the compression indicated on the instrument. To compress the fracture, use the 4.5mm Universal Drill Guide [00-2808-045-04].**

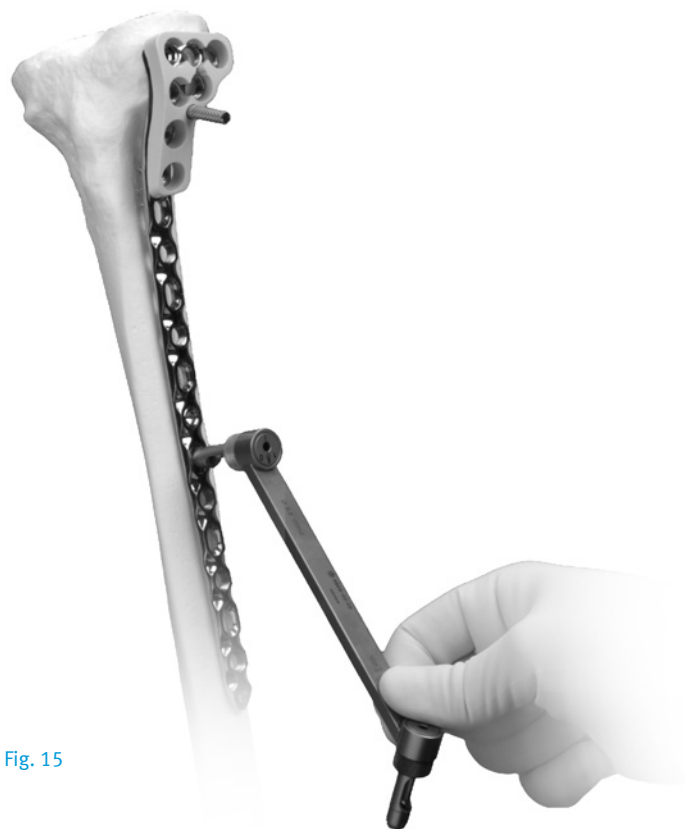

Fig. 15

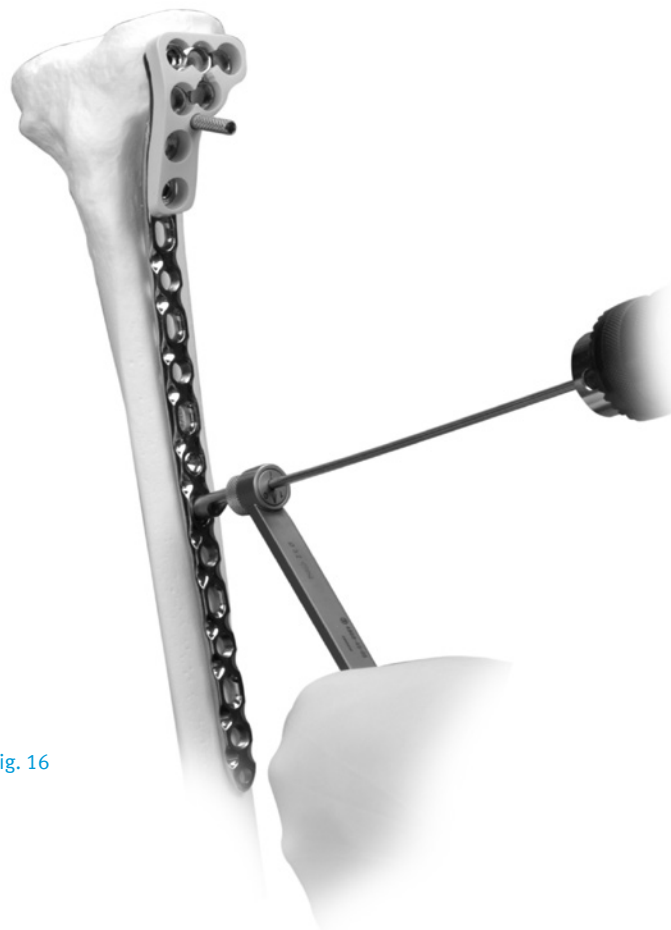

Fig. 16

Use the Depth Gauge to measure the appropriate screw length (Fig. 17). Then insert a self-tapping lag screw (Fig. 18). Check the position of the screw with the fluoroscope. Repeat this procedure for each of the standard screws to be inserted.

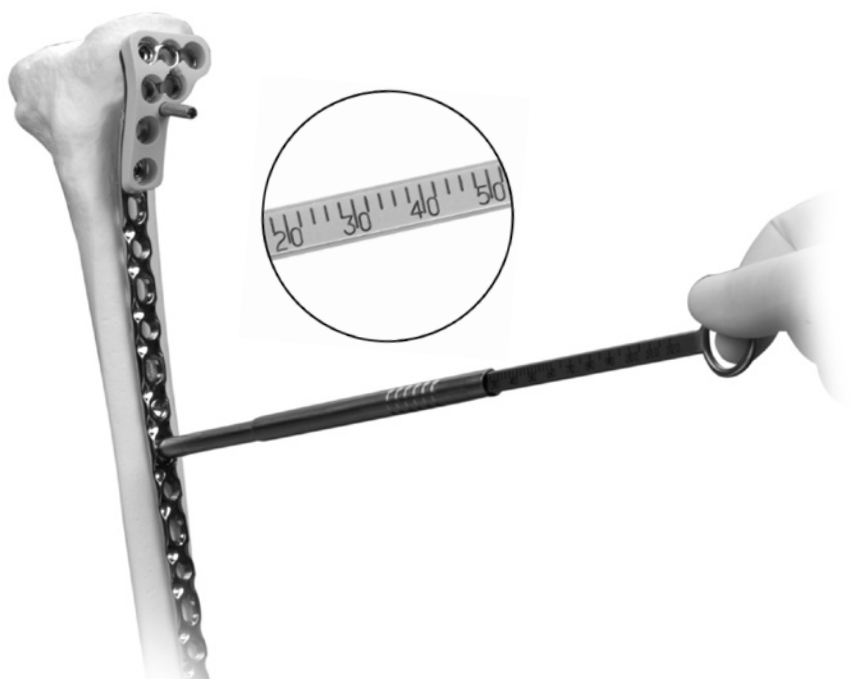

Fig 18

To insert locking screws, thread the 3.7mm Standard Cannula into the most proximal shaft locking hole of the plate (Fig. 19). Use the 3.7mm Standard Drill through the cannula to drill a pilot hole (Fig. 20). Check the depth and position of the drill with fluoroscopic



Fig. 19



Fig. 20

images. Remove the cannula and use the Depth Gauge (Fig. 21) to measure the appropriate screw length. Then insert the locking screw (Fig. 22).

Tapping is typically not necessary as the flutes of the screws are self-drilling and self-tapping. If the bone is dense, the lateral cortex can be tapped using the 4.5mm Locking Screw Tap.

Insert additional locking screws as desired.



Fig. 21

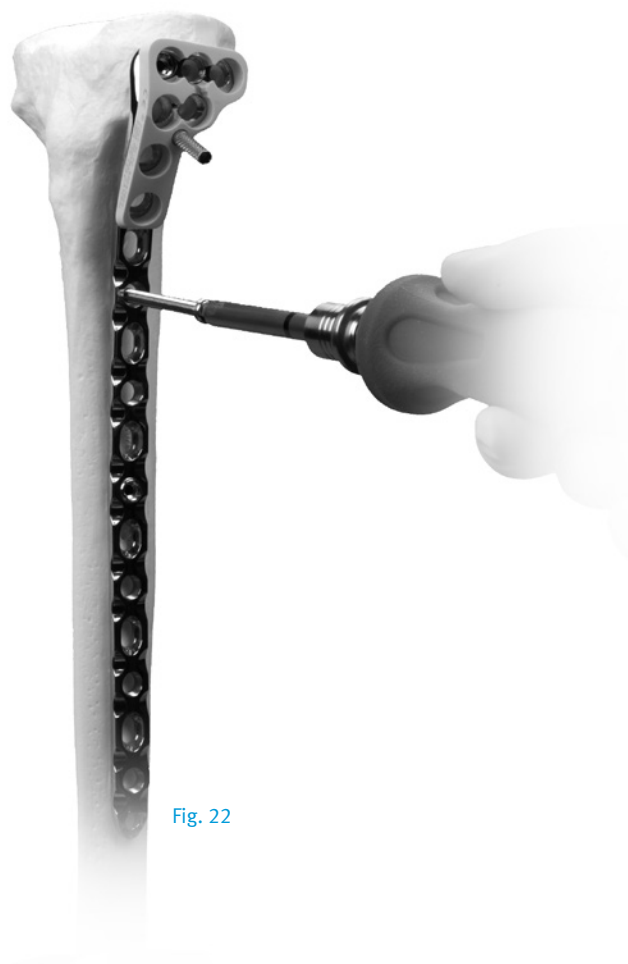

Fig. 22



### Strut Screw Fixation

A locking strut screw can be inserted into the plate to support a medial fragment. Insert a 5.5mm Jig Sleeve and a 3.2mm Standard Cannula (Fig. 23) into the oblique locking hole. Then insert a 3.2mm Drill Tip Guide Wire through the Cannula (Fig. 24) until the tip engages the medial cortical wall. Use the fluoroscope to confirm the position of the wire in both the A/P and lateral planes.

**NOTE:** To avoid interference with other screws, the Strut Screw should be 80mm in length or shorter.



Fig. 23

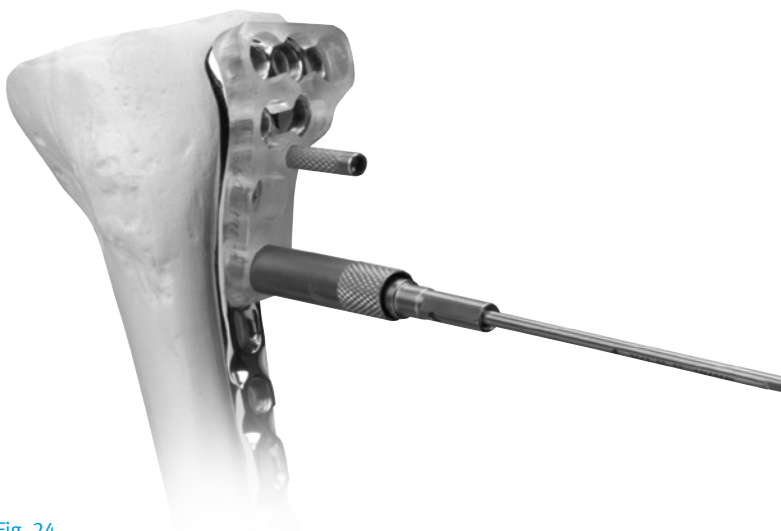

Fig. 24

Remove the Guide Wire Cannula and use the 5.0mm Hex Cannulated Driver (Fig. 25) to insert a Cannulated Conical or Locking Screw over the guide wire.

Make a final check of the limb alignment and fracture reduction. Then make sure that all locking screws in the head and shaft are securely tightened before closing.

### Wound Closure

Use the appropriate method for surgical closure of the incision.

### Postoperative Treatment

Postoperative treatment with locking plates does not differ from conventional open reduction internal fixation (ORIF) procedures. Limited weight-bearing and early knee motion are recommended.

### Implant Removal

To remove locking screws, use the large hexagonal screwdriver, 5.0mm hex to first unlock all screws from the plate and then remove screws completely. Do not use the Forward Captive Drivers for screw removal.

Please refer to the package insert for product information, including contraindications, warnings, and precautionary information.



Fig. 25

## Instrument and Implants



**5.5mm Proximal Lateral Tibial Plate Jig,**  
Right 00-2360-091-01, Left 00-2360-091-02



**5.5mm/4.5mm Standard Jig Sleeve** 00-2360-090-04



**3.2mm Standard Cannula** 00-2360-021-32



**5.5mm/4.5mm Cannula Inserter** 00-2360-088-00



**3.2mm Standard Drill Tip Guide Wire** 00-2360-033-32



**Guide Wire Inserter** 00-2360-085-00



**5.5mm Cannulated Locking Screw Depth Gauge**  
00-2360-041-55



**4.7mm Std Cannulated Drill** 00-2360-071-47



**5.0mm Hex Std Cannulated Screwdriver** 00-2360-166-50



**Modular Handle** 00-2360-186-00



**3.7mm Standard Cannula** 00-2360-020-37



**3.7mm Std Drill** 00-2360-225-37



**4.5mm Locking Screw Standard Depth Gauge**  
00-2360-040-45



**4.5mm Locking Screw Tap** 00-2360-053-45



**5.0mm Hex Std Screwdriver** 00-2360-165-50

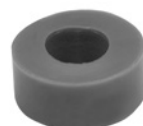

**5.0mm Screwdriver Stop Ring** 00-2360-065-05

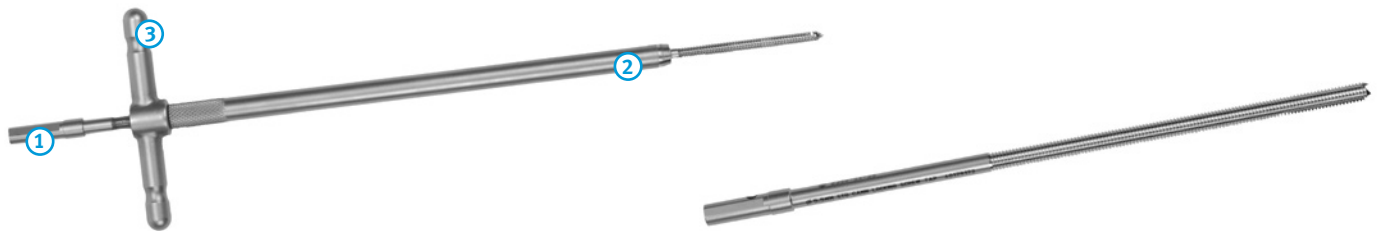

**1 5.5mm / 4.5mm Locking Plate Reduction Instrument**  
00-2360-012-01

**2 5.5mm / 4.5mm Plate Reduction Sleeve** 00-2360-012-02

**3 Spin Knob** 00-2360-012-03

**5.5mm Std Cannulated Locking Screw Tap** 00-2360-054-55

## Order Information

Part Number	Description		
<b>00-2360-000-12</b>	<b>5.5mm Proximal Tibial Plate Standard Jig Set</b>		
00-2360-091-01	5.5mm Proximal Lateral Tibial Plate Jig, Right	00-2360-085-00	Guide Wire Insertor
00-2360-091-02	5.5mm Proximal Lateral Tibial Plate Jig, Left	00-2360-186-00	Modular Handle
00-2358-015-05	5.5mm Proximal Lateral Tibial Plate/Jig Case	00-2360-088-00	5.5mm/4.5mm Cannula Insertor
00-2358-015-05	Ratcheting Modular Handle	00-2360-065-05	5.0mm Screwdriver Stop Ring
00-2360-093-03	Standard Jig Set Screw 2 ea.	00-2360-080-05	Torque Limiting Attachment
<b>00-2357-000-08</b>	<b>5.5mm Prox Lat Tib Lck Plt Set</b>	00-4812-045-00	Large Hex Screwdriver (1 ea.)
00-2357-006-04	5.5mm Proximal Lateral Tibial Locking Plate, 4 Hole, 97mm Long, Left	00-2360-090-04	5.5mm/4.5mm Standard Jig Sleeve (4 ea.)
00-2357-006-06	5.5mm Proximal Lateral Tibial Locking Plate, 6 Hole, 128mm Long, Left	<b>00-2359-000-01</b>	<b>5.5mm/4.5mm Locking Screw Set</b>
00-2357-006-08	5.5mm Proximal Lateral Tibial Locking Plate, 8 Hole, 158mm Long, Left	00-2359-030-55	5.5mm Cannulated Locking Screw 30mm Long
00-2357-006-10	5.5mm Proximal Lateral Tibial Locking Plate, 10 Hole, 189mm Long, Left	00-2359-035-55	5.5mm Cannulated Locking Screw 35mm Long
00-2357-006-12	5.5mm Proximal Lateral Tibial Locking Plate, 12 Hole, 219mm Long, Left	00-2359-040-55	5.5mm Cannulated Locking Screw 40mm Long
00-2357-006-14	5.5mm Proximal Lateral Tibial Locking Plate, 14 Hole, 250mm Long, Left	00-2359-045-55	5.5mm Cannulated Locking Screw 45mm Long
00-2357-005-04	5.5mm Proximal Lateral Tibial Locking Plate, 4 Hole, 97mm Long, Right	00-2359-050-55	5.5mm Cannulated Locking Screw 50mm Long
00-2357-005-06	5.5mm Proximal Lateral Tibial Locking Plate, 6 Hole, 128mm Long, Right	00-2359-055-55	5.5mm Cannulated Locking Screw 55mm Long
00-2357-005-08	5.5mm Proximal Lateral Tibial Locking Plate, 8 Hole, 158mm Long, Right	00-2359-060-55	5.5mm Cannulated Locking Screw 60mm Long
00-2357-005-10	5.5mm Proximal Lateral Tibial Locking Plate, 10 Hole, 189mm Long, Right	00-2359-065-55	5.5mm Cannulated Locking Screw 65mm Long
00-2357-005-12	5.5mm Proximal Lateral Tibial Locking Plate, 12 Hole, 219mm Long, Right	00-2359-070-55	5.5mm Cannulated Locking Screw 70mm Long
00-2357-005-14	5.5mm Proximal Lateral Tibial Locking Plate, 14 Hole, 250mm Long, Right	00-2359-075-55	5.5mm Cannulated Locking Screw 75mm Long
<b>Also available:</b>		00-2359-080-55	5.5mm Cannulated Locking Screw 80mm Long
47-2357-006-18	5.5mm Proximal Lateral Tibial Locking Plate, 18 Hole, 311mm Long, Left, Sterile Only	00-2359-085-55	5.5mm Cannulated Locking Screw 85mm Long
47-2357-006-22	5.5mm Proximal Lateral Tibial Locking Plate, 22 Hole, 372mm Long, Left, Sterile Only	00-2359-090-55	5.5mm Cannulated Locking Screw 90mm Long
47-2357-005-18	5.5mm Proximal Lateral Tibial Locking Plate, 18 Hole, 311mm Long, Right, Sterile Only	00-2359-095-55	5.5mm Cannulated Locking Screw 95mm Long
47-2357-005-22	5.5mm Proximal Lateral Tibial Locking Plate, 22 Hole, 372mm Long, Right, Sterile Only	00-2359-100-55	5.5mm Cannulated Locking Screw 100mm Long
<b>00-2360-000-01</b>	<b>5.5mm/4.5mm Periarticular Locking Screw and Instrument Set</b>	00-2359-050-56	5.5mm Cannulated Conical Screw 50mm Long
00-1147-073-00	Cleaning Stylet	00-2359-055-56	5.5mm Cannulated Conical Screw 55mm Long
00-1147-078-00	Cleaning Brush	00-2359-060-56	5.5mm Cannulated Conical Screw 60mm Long
00-2358-035-05	5.5mm/4.5mm Locking Screw Instrument Case	00-2359-065-56	5.5mm Cannulated Conical Screw 65mm Long
00-2360-012-01	5.5mm/4.5mm Plate Reduction Instrument	00-2359-070-56	5.5mm Cannulated Conical Screw 70mm Long
00-2360-012-02	5.5mm/4.5mm Plate Reduction Sleeve	00-2359-075-56	5.5mm Cannulated Conical Screw 75mm Long
00-2360-012-03	Plate Reduction Spin Knob	00-2359-080-56	5.5mm Cannulated Conical Screw 80mm Long
00-2360-020-37	3.7mm Standard Cannula	00-2359-085-56	5.5mm Cannulated Conical Screw 85mm Long
00-2360-021-32	3.2mm Standard Cannula	00-2359-090-56	5.5mm Cannulated Conical Screw 90mm Long
00-2360-033-32	3.2mm Standard Drill Tip Guide Wire (5 per box)	00-2359-012-45	4.5mm Locking Screw 12mm long
00-2360-040-45	4.5mm Locking Screw Standard Depth Gauge	00-2359-014-45	4.5mm Locking Screw 14mm long
00-2360-041-55	5.5mm Cannulated Locking Screw Depth Gauge	00-2359-016-45	4.5mm Locking Screw 16mm long
00-2360-053-45	4.5mm Locking Screw Tap	00-2359-018-45	4.5mm Locking Screw 18mm long
00-2360-054-55	5.5mm Cannulated Locking Screw Tap	00-2359-020-45	4.5mm Locking Screw 20mm long
00-2360-165-50	5.0mm Hex Standard Screwdriver	00-2359-022-45	4.5mm Locking Screw 22mm long
00-2360-166-50	5.0mm Hex Standard Cannulated Screwdriver	00-2359-024-45	4.5mm Locking Screw 24mm long
00-2360-071-47	4.7mm Standard Cannulated Drill	00-2359-026-45	4.5mm Locking Screw 26mm long
00-2360-225-37	3.7mm Standard Drill	00-2359-028-45	4.5mm Locking Screw 28mm long
00-2360-087-00	Ratcheting Modular Handle	00-2359-030-45	4.5mm Locking Screw 30mm long
		00-2359-032-45	4.5mm Locking Screw 32mm long
		00-2359-034-45	4.5mm Locking Screw 34mm long
		00-2359-036-45	4.5mm Locking Screw 36mm long
		00-2359-038-45	4.5mm Locking Screw 38mm long
		00-2359-040-45	4.5mm Locking Screw 40mm long
		00-2359-042-45	4.5mm Locking Screw 42mm long
		00-2359-044-45	4.5mm Locking Screw 44mm long
		00-2359-046-45	4.5mm Locking Screw 46mm long
		00-2359-048-45	4.5mm Locking Screw 48mm long
		00-2359-050-45	4.5mm Locking Screw 50mm long
		00-2359-055-45	4.5mm Locking Screw 55mm long
		00-2359-060-45	4.5mm Locking Screw 60mm long
		00-2359-065-45	4.5mm Locking Screw 65mm long
		00-2359-070-45	4.5mm Locking Screw 70mm long

## Surgical Technique for the Periarticular 3.5mm Proximal Tibial Locking Plate

### Required Instrumentation

The following sets may be required for application of the 3.5mm Periarticular Locking Proximal Tibia Plate:

- Small Fragment Screw and Instrument Set
- Cannulated Screws
- Basic Forceps Set
- 3.5mm/2.7mm Locking Screw and Instrument Set
- 3.5mm Locking Proximal Tibia Plate and Standard Jig Set

**NOTE: The 2.7mm Locking Screws should not be used with the 3.5mm Locking Proximal Tibial Plate.**

### Preoperative Preparation

After assessing the fracture radiographically and preparing a preoperative plan, place the patient in the supine position on a radiolucent table. Be sure that the fluoroscope can be positioned to visualize the proximal tibia in both the lateral and Anterior/Posterior (A/P) views.

Through A/P and M/L templating, assess the ability of the lateral plate to capture and adequately stabilize any medial fragments. If adequate fixation is not feasible, a medial buttress plate should also be considered.

### Surgical Approach

The patient is positioned supine on a radiolucent operating table.

A straight lateral parapatellar incision is made. This incision can be extended proximally and/or distally as more exposure is required (Fig. 26).

The dissection should go straight down to the bone by detaching the lateral muscle origins and splitting the fibers of the iliotibial tract. The knee joint is then opened below the lateral meniscus in order to get a good view of the articular surface.

Do not dissect across the tibial tuberosity – unless absolutely necessary – the soft tissue coverage on the medial side is very delicate. Take care not to place incisions over the proposed sites of implants, or where there is risk of devitalizing sensitive structures.

When treating fractures with a bicondylar component, an additional posteromedial incision is recommended (Fig. 27).

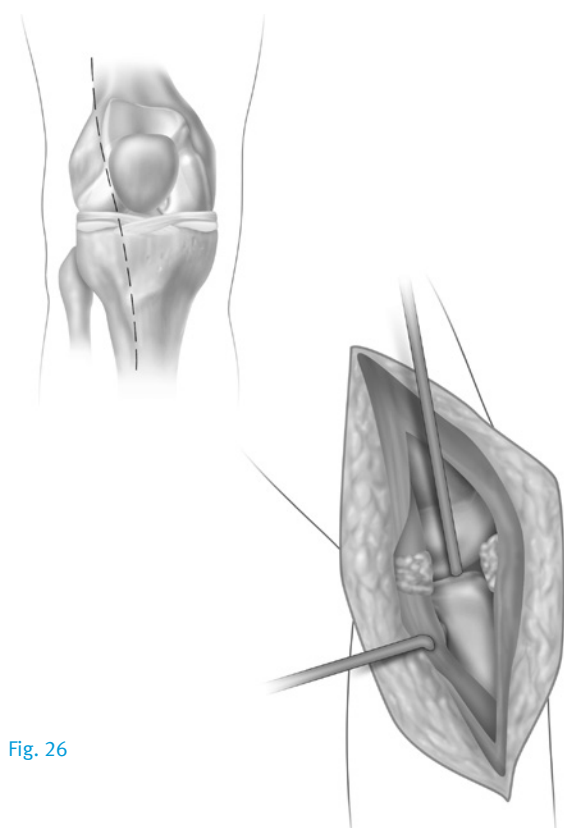

Fig. 26

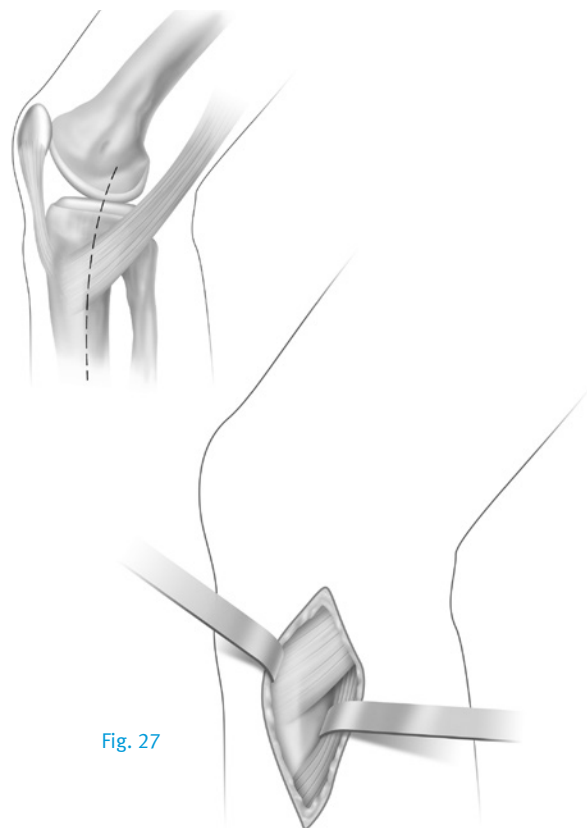

Fig. 27

### Fracture Reduction

It is imperative that accurate reduction of the fracture be obtained prior to or through application of the plate and maintained during application of the proximal tibial plate.

Reduce the intra-articular fragments using linear bone clamps or Kirschner wires to temporarily hold the reduction. Use lag screws to secure the intra-articular fragments. To help avoid inserting the lag screws where they will interfere with the plate placement, hold the plate on the bone in its approximate position. Then insert the lag screws as needed – the lag screws can often be placed through the plate using cannulated conical screws, or may be inserted in subchondral bone proximal to the plate.

### Plate Positioning

Hold the appropriate Metaphyseal Jig (Fig. 28) on the selected plate and finger tighten the set screw. Insert the 3.5mm Standard Jig Sleeve into one of the most proximal holes of the Jig and thread the 1.6mm Standard Cannula into the plate hole (Fig. 29).

Before placing the plate on the bone, using the Jig Sleeve, thread the appropriate number of Standard Cannulas into each of the other proximal holes in the head of the plate (Fig. 30). **It is easier to thread the cannulas into the plate holes before the plate is applied to the bone. The cannulas can be used as handles to position the plate.**

**Note: Cannulas in the proximal row of the jig cannot be inserted next to one another.**

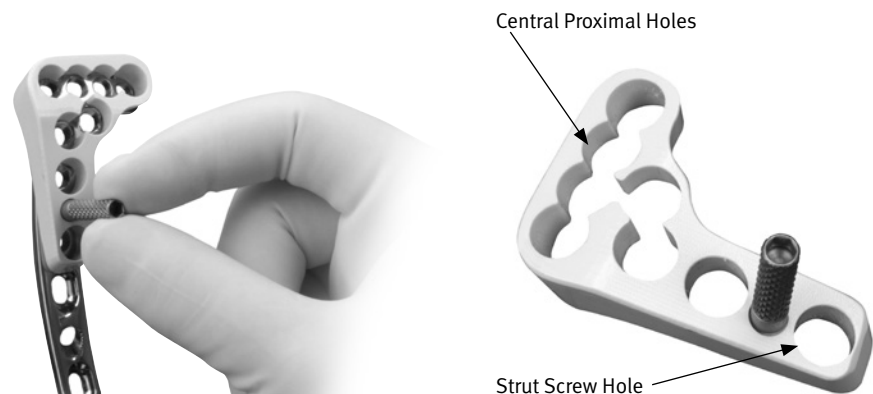

Fig. 28

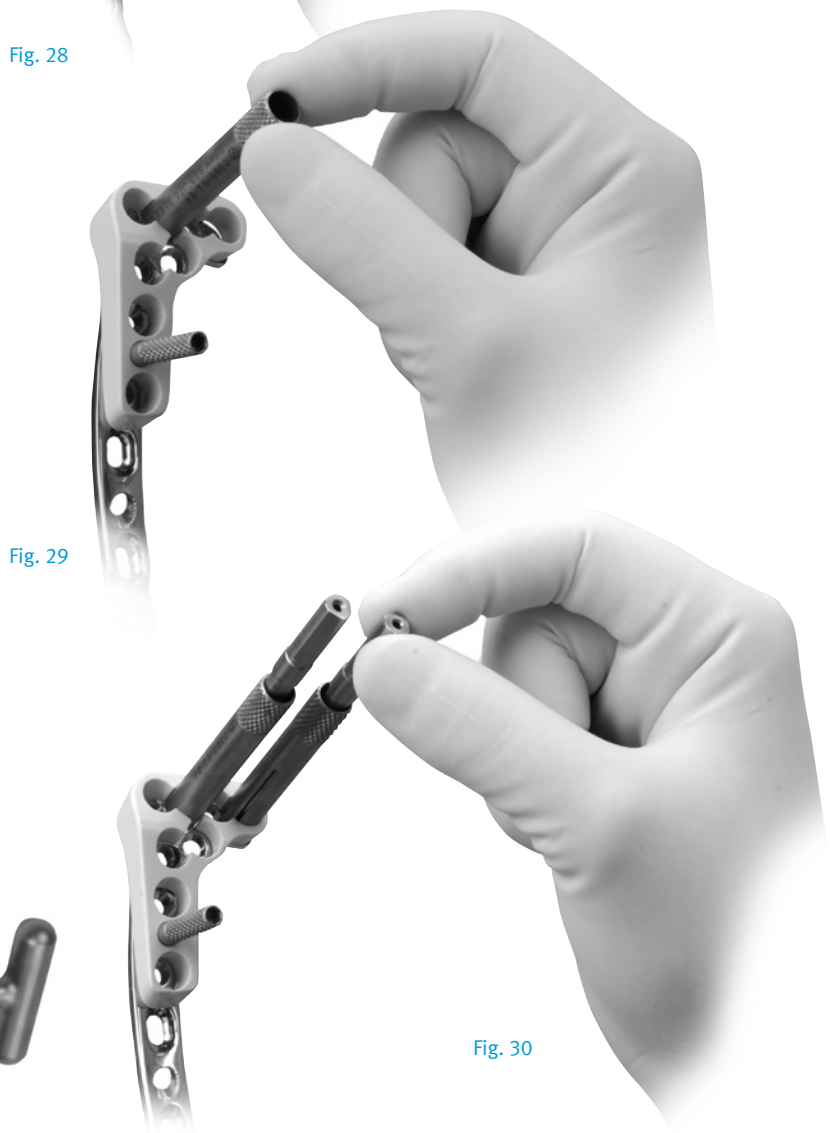

Fig. 30



Use this construct to place the initial 1.6mm Drill Tip Guide Wire in the metaphysis. Check plate placement – visually and fluoroscopically to ensure that the plate is positioned correctly on the metaphysis of the bone. If placement is appropriate, hold the Jig on the plate and finger tighten the set screw.

Use A/P and lateral fluoroscopic images to position the plate. **Note: The position of the plate on the bone must be verified because there is a tendency to place the distal end of the plate too posterior on the tibial shaft. Posterior placement can cause the locking screws to be placed at a tangent and can result in insufficient holding strength.** Because the tibial shaft may not be aligned with the proximal fragment, the plate head should be used to determine the appropriate placement of the plate. The plate head should conform to the shape of the intact or reconstructed proximal tibia. This will determine the alignment of the shaft.

**WARNING: Do not contour or bend the plate at or near a threaded hole, as doing so may deform the threaded hole and cause incompatibility with the locking screw.**

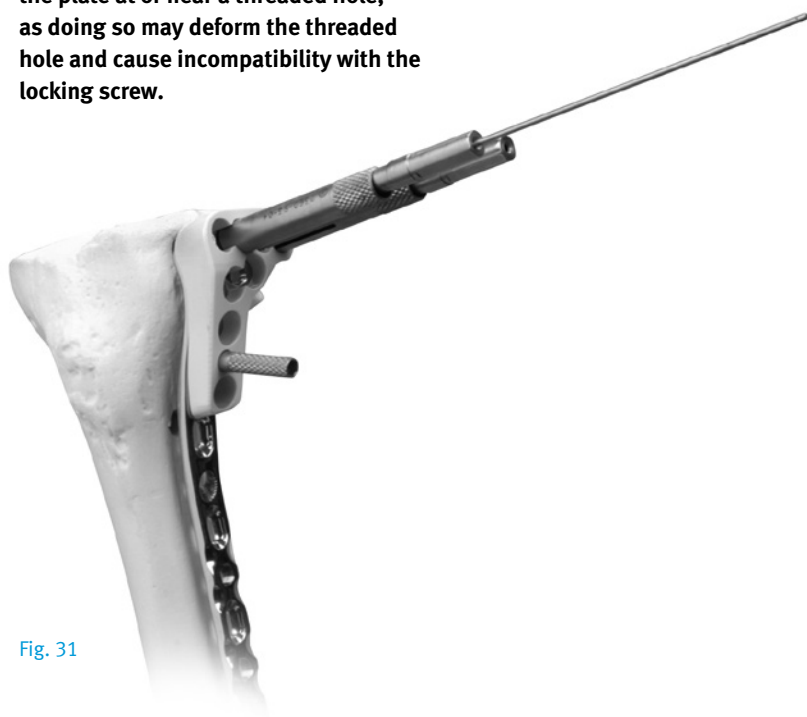

Fig. 31

Hold the plate in the desired position and insert a 1.6mm Drill Tip Guide Wire (Fig. 31) through one of the central Guide Wire Cannulas until the tip engages the opposite cortical wall. Use the fluoroscope to confirm the position of the wire in both the A/P and lateral planes. Adjust the wire location if necessary. If preferred, use a linear bone clamp or bone reduction instrument to secure the plate.

When the first wire is satisfactory, adjust the plate rotation, if necessary. The next step is to align the plate shaft with the tibial shaft. Insert a 2.7mm standard cannula into the most distal plate shaft hole. Use the 2.7mm drill bit through the cannula. Make certain under A/P and lateral fluoroscopy that the plate shaft and tibial shaft are aligned properly.

Measure for the 3.5mm locking screw length using the 3.5mm/2.7mm standard locking screw depth gauge. Insert the 3.5mm locking screw. Then insert Drill Tip Guide Wires through the other proximal Guide Wire Cannulas to help prevent rotation of the plate.

**NOTE: If desired, after removal of the metaphyseal jig, additional 1.6mm Drill Tip Guide Wires can be inserted through the proximal K-wire holes to further stabilize the plate (Fig. 32).**

Use the fluoroscope for both A/P and lateral views to confirm the position of the plate head, shaft, and guide wires. The guide wires should be parallel to the joint line.



Fig. 32

### Screw Trajectory

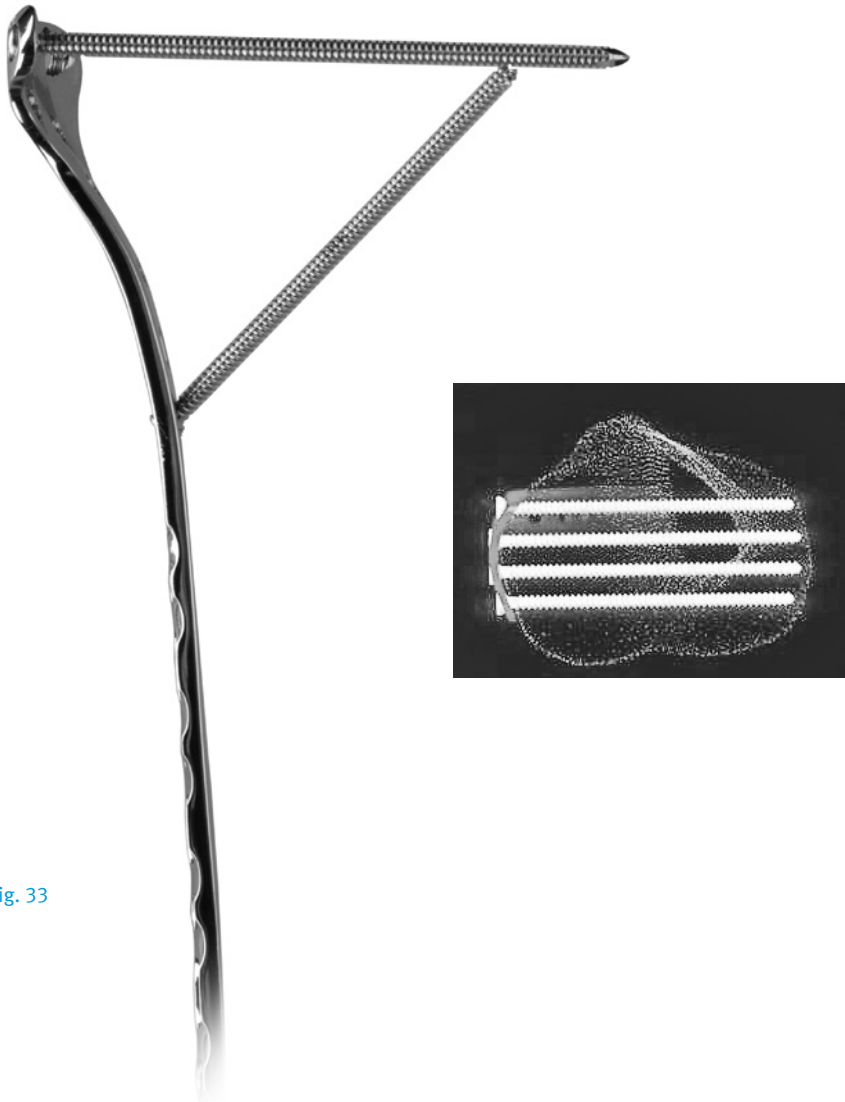

Fig. 33

## Fracture Fixation

### Metaphyseal Screw Fixation

**If required, lag screw reduction of a fragment or compression of the articular surface must be accomplished before inserting any locking screws. The 3.5mm Cannulated Conical Screws can be used for lag screw fixation (Fig. 34).**

Once the plate is properly positioned, slide the 3.5mm Cannulated Screw Depth Gauge (Fig. 35) over the guide wires to measure for the screw lengths. The tip of the gauge must contact the end of the guide wire cannula for an accurate measurement. This will position the tip of the screw at the tip of the guide wire. Read the proper screw length from the guide.

Predrilling and tapping are typically not necessary as the flutes of the screws are self-drilling and self-tapping. If the bone is dense, the lateral cortex can be predrilled using the 2.7mm Cannulated Drill and tapped using the 3.5mm Cannulated Screw Tap.



Fig. 34



Fig. 35

Slide the Screwdriver Stop Ring onto the screwdriver shaft and place it at the level of the black ring etched on the driver shaft. Before the Blue Stop Ring approaches the top of the Jig Sleeve, power insertion should stop. Screws must be seated by hand. The Screwdriver Stop Ring is intended to be a visual cue to stop power insertion of the locking screws.

Remove the Guide Wire Cannulas and use the 2.5mm Hex-head Cannulated Driver (Fig. 36) to insert a 3.5mm Cannulated Conical or Cannulated Locking Screw over each of the guide wires (Fig. 37) and into the proximal holes.

**NOTE: A screwdriver shaft can be used to loosely insert the screw under power, but the final seating must be accomplished by hand to avoid cross-threading of the screws in the plate holes or failure of the screw or driver.**

Follow the same procedure for each proximal screw. Be sure that all screws are securely tightened.

**NOTE: If the plate shifts during screw insertion, all the pins and screws must be removed and reinserted for the screws to lock properly to the plate.**

**NOTE: If a plate screw impinges on one of the intra-articular lag screws, the lag screw must be removed and repositioned.**

Use direct or indirect reduction techniques to reduce the proximal tibia to the shaft. Confirm that the leg is in proper rotation. Temporarily secure the plate shaft to the bone with plate holding forceps, a nonlocking screw or the appropriate plate reduction instrument.

If lag screws will be used through some of the slots in the shaft, insert the first lag screw to reduce the fracture or reduce the plate to the bone.

**NOTE: Screws inserted into the second row of metaphyseal holes should be less than 75mm in length to avoid interference with other screws.**

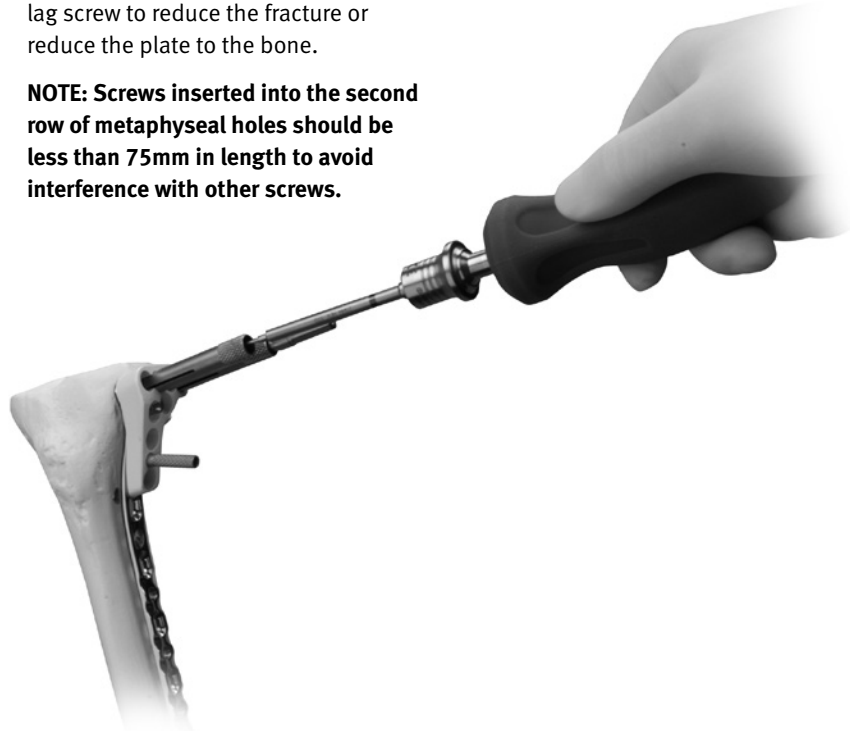
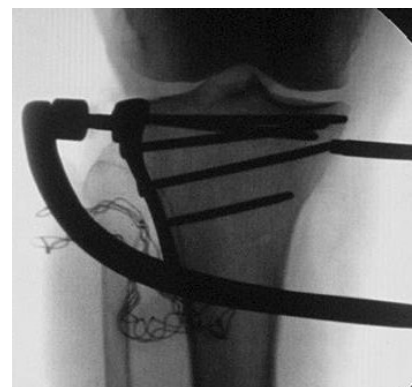

Fig. 36



Fig. 37



### Shaft Fixation

If both locking and nonlocking screws will be used in the shaft, the nonlocking screws must be inserted first. Insert additional nonlocking screws through the compression slots in the plate as desired.

Apply the appropriate drill guide (3.5mm/2.5 Double Drill Sleeve [00-4808-035-01], 3.5mm/2.5 Insert Drill Sleeve [00-4808-035-02], 3.5mm Universal Drill Guide [00-4808-035-04], to one of the nonlocking shaft holes, and use the Standard Drill to drill through both cortices. Use the Depth Gauge to measure the appropriate screw length. Then insert a self-tapping lag screw. Check the position of the screw with the fluoroscope. Repeat this procedure for each of the nonlocking screws to be inserted.

To insert locking screws, thread the 2.7mm Standard Cannula into a locking hole in the shaft of plate. Use the 2.7mm Standard Drill through the cannula to drill a pilot hole (Fig. 38). Check the depth and position of the drill with fluoroscopic images.

**NOTE: Use of the 3.5mm Compression Drill Guide [00-4808-035-05] in the Periarticular Proximal Tibial Locking Plate will not generate the compression indicated on the instrument. To compress the fracture, use the 3.5mm Universal Drill Guide [00-2808-045-04] Remove the cannula and use the Depth Gauge to measure (Fig. 39 and 40) the appropriate screw length. Then insert the locking screw (Fig. 41).**



Fig. 38

Tapping is typically not necessary as the flutes of the screws are self-drilling and self-tapping. If the bone is dense, the lateral cortex can be tapped using the 3.5mm Locking Screw tap.

Insert locking screws as desired through the remaining locking holes of the shaft in the same manner.

#### Strut Screw Fixation

A locking strut screw can be inserted into the plate to support a medial fragment. Insert a jig sleeve and a 1.6mm Standard



Fig. 39



Fig. 40

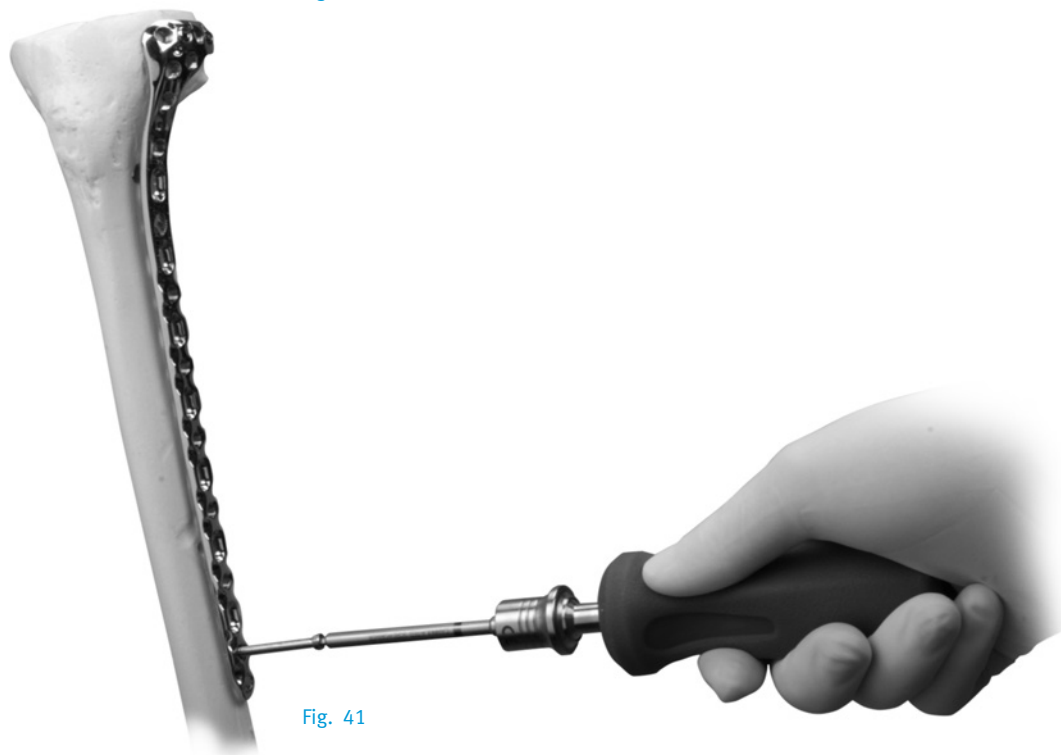

Fig. 41

Cannula into the 1.6mm oblique locking hole (Fig. 42). Then insert a Drill Tip Guide Wire through the Cannula until the tip engages the medial cortical wall (Fig. 43). Use the fluoroscope to confirm the position of the wire in both the A/P and lateral planes.

**NOTE: To avoid interference with other screws, the Strut Screw should be less than 70mm in length.**

Slide the Cannulated Locking Screw Depth Gauge over the guide (Fig. 44) wire to measure for the screw length, making sure that the tip of the gauge contacts



Fig. 42



Fig. 43

the end of the guide wire cannula. This will position the tip of the screw at the tip of the guide wire. Read the proper screw length from the guide.

Remove the Guide Wire Cannula and use the 2.5mm Hex-head Cannulated Driver to insert a Cannulated Locking Screw over the guide wire (Fig. 45).

Make a final check of the limb alignment and fracture reduction. Then make sure that all locking screws in the head and shaft are securely tightened before closing.

### Wound Closure

Use the appropriate method for surgical closure of the incision.

### Postoperative Treatment

Postoperative treatment with locking plates does not differ from conventional open reduction internal fixation (ORIF) procedures. Limited weight-bearing and early knee motion are recommended.

### Implant Removal

To remove locking screws, use the small hexagonal screwdriver, 2.5mm hex to first unlock all screws from the plate and then remove screws completely. Do not use the Forward Captive Drivers for screw removal.

Please refer to the package insert for product information, including contraindications, warnings, and precautionary information.



Fig. 44



Fig. 45



### Instrument and Implants



**3.5mm Proximal Lateral Tibial Plate Jig,**  
Right, 00-2360-093-01, Left 00-2360-093-02



**3.5mm Standard Jig Sleeve** 00-2360-093-04



**1.6mm Standard Cannula** 00-2360-021-16



**Cannula Inserter** 00-2360-088-00



**1.6mm Standard Drill Tip Guide Wire** 00-2360-033-16



**3.5mm/2.7mm Locking Screw Depth Gauge**  
00-2360-040-35



**2.7 Standard Drill** 00-2360-205-27



**2.7mm Standard Cannula** 00-2360-020-27



**2.5mm Hex Standard Cannulated Screwdriver**  
00-2360-166-25



**2.0mm Standard Cannula** 00-2360-020-20



**2.0mm Standard Drill** 00-2360-175-20



**2.5mm Hex Standard Screwdriver** 00-2360-165-25



**3.5mm Cannulated Locking Screw Depth Gauge**  
00-2360-041-35



**1 3.5mm / 2.7mm Locking Plate Reduction Instrument**  
00-2360-011-01

**2 3.5mm / 2.7mm Plate Reduction Sleeve** 00-2360-011-02

**3 Spin Knob** 00-2360-011-03

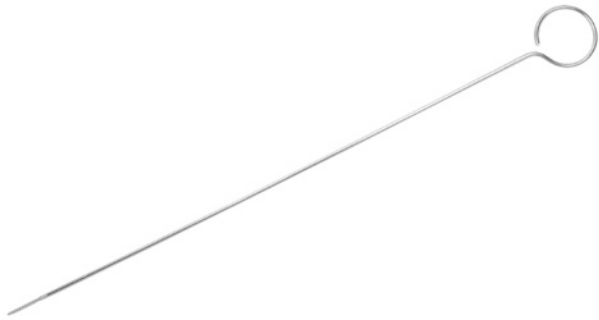

**Cleaning Brush** 00-1147-076-00

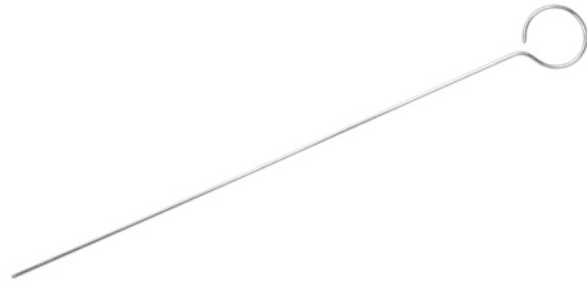

**Cleaning Stylet** 00-1147-071-00



**2.7mm Std Locking Screw Tap** 00-2360-153-27



**3.5mm Std Locking Screw Tap** 00-2360-153-35



**3.5mm Std Cannulated Locking Screw Tap** 00-2360-154-35

## Order Information

Part Number	Description
<b>00-2360-000-02</b>	<b>3.5mm/2.7mm Periarticular Locking Screw and Instrument Set</b>
00-2360-186-00	Modular Handle
00-1147-053-00	Cannulated Ratchet Handle
00-1147-071-00	Cleaning Stylet
00-1147-076-00	Cleaning Brush
00-2358-040-05	3.5/2.7mm Locking Screw and Instrument Case
00-2360-011-01	3.5mm/2.7mm Plate Reduction Instrument
00-2360-011-02	3.5mm/2.7mm Plate Reduction Sleeve
00-2360-011-03	Plate Reduction Spin Knob
00-2360-020-20	2.0mm Standard Cannula
00-2360-021-16	1.6mm Standard Cannula
00-2360-033-16	1.6mm Standard Drill Tip Guide Wire (5 per box)
00-2360-040-35	3.5mm/2.7mm Locking Screw Standard Depth Gauge
00-2360-041-35	3.5mm Cannulated Locking Screw Depth Gauge
00-2360-065-00	2.5mm Screwdriver Stop Ring
00-2360-080-00	Torque Limiting Attachment
00-2360-088-00	Cannula Inserter
00-2360-093-04	3.5mm Standard Jig Sleeve
00-2360-153-27	2.7mm Locking Screw Tap
00-2360-153-35	3.5mm Locking Screw Tap
00-2360-154-35	3.5mm Cannulated Locking Screw Tap
00-2360-165-25	2.5mm Hex Standard Screwdriver
00-2360-166-25	2.5mm Hex Standard Cannulated Screwdriver
00-2360-171-27	2.7mm Standard Cannulated Drill 1QC
00-2360-175-20	2.0mm Standard Drill
00-2360-205-27	2.7mm Standard Drill
00-4811-035-01	Handle, QC Phenolic
00-4812-035-00	Small Hex Screwdriver
00-4812-045-00	Large Hex Screwdriver
00-2360-020-27	2.7mm Standard Cannula
00-2360-186-00	Modular Handle
<b>00-2360-000-15</b>	<b>3.5mm Proximal Tibial Standard Jig Set</b>
00-2360-093-01	3.5mm Proximal Lateral Tibial Plate Jig, Right
00-2360-093-02	3.5mm Proximal Lateral Tibial Plate Jig, Left
00-2358-050-05	3.5mm Proximal Lateral Tibial Plate/Jig Case
00-2360-093-03	Standard Jig Set Screw (2 ea)
<b>00-2357-000-09</b>	<b>3.5mm Proximal Lateral Tibial Locking Plate Set</b>
00-2357-004-06	3.5mm Proximal Lateral Tibial Locking Plate, 6 Hole, 104mm Long, Left
00-2357-004-08	3.5mm Proximal Lateral Tibial Locking Plate, 8 Hole, 128mm Long, Left
00-2357-004-10	3.5mm Proximal Lateral Tibial Locking Plate, 10 Hole, 152mm Long, Left
00-2357-004-12	3.5mm Proximal Lateral Tibial Locking Plate, 12 Hole, 176mm Long, Left
00-2357-004-14	3.5mm Proximal Lateral Tibial Locking Plate, 14 Hole, 200mm Long, Left
00-2357-004-16	3.5mm Proximal Lateral Tibial Locking Plate, 16 Hole, 224mm Long, Left
00-2357-003-06	3.5mm Proximal Lateral Tibial Locking Plate, 6 Hole, 104mm Long, Right
00-2357-003-08	3.5mm Proximal Lateral Tibial Locking Plate, 8 Hole, 128mm Long, Right
00-2357-003-10	3.5mm Proximal Lateral Tibial Locking Plate, 10 Hole, 152mm Long, Right
00-2357-003-12	3.5mm Proximal Lateral Tibial Locking Plate, 12 Hole, 176mm Long, Right
00-2357-003-14	3.5mm Proximal Lateral Tibial Locking Plate, 14 Hole, 200mm Long, Right
00-2357-003-16	3.5mm Proximal Lateral Tibial Locking Plate, 16 Hole, 224mm Long, Right
<b>00-2359-000-02</b>	<b>3.5mm / 2.7mm Locking Screw Set</b>
00-2359-030-36	3.5mm Cannulated Locking Screw 30mm Long
00-2359-035-36	3.5mm Cannulated Locking Screw 35mm Long
00-2359-040-36	3.5mm Cannulated Locking Screw 40mm Long
00-2359-045-36	3.5mm Cannulated Locking Screw 45mm Long
00-2359-050-36	3.5mm Cannulated Locking Screw 50mm Long
00-2359-055-36	3.5mm Cannulated Locking Screw 55mm Long
00-2359-060-36	3.5mm Cannulated Locking Screw 60mm Long

00-2359-065-36	3.5mm Cannulated Locking Screw 65mm Long	00-2359-054-35	3.5mm Locking Screw 54mm Long
00-2359-070-36	3.5mm Cannulated Locking Screw 70mm Long	00-2359-056-35	3.5mm Locking Screw 56mm Long
00-2359-075-36	3.5mm Cannulated Locking Screw 75mm Long	00-2359-058-35	3.5mm Locking Screw 58mm Long
00-2359-080-36	3.5mm Cannulated Locking Screw 80mm Long	00-2359-060-35	3.5mm Locking Screw 60mm Long
00-2359-085-36	3.5mm Cannulated Locking Screw 85mm Long	00-2359-065-35	3.5mm Locking Screw 65mm Long
00-2359-090-36	3.5mm Cannulated Locking Screw 90mm Long	00-2359-070-35	3.5mm Locking Screw 70mm Long
00-2359-030-37	3.5mm Cannulated Conical Screw 30mm Long	00-2359-075-35	3.5mm Locking Screw 75mm Long
00-2359-035-37	3.5mm Cannulated Conical Screw 35mm Long	00-2359-080-35	3.5mm Locking Screw 80mm Long
00-2359-040-37	3.5mm Cannulated Conical Screw 40mm Long	00-2359-085-35	3.5mm Locking Screw 85mm Long
00-2359-045-37	3.5mm Cannulated Conical Screw 45mm Long	00-2359-090-35	3.5mm Locking Screw 90mm Long
00-2359-050-37	3.5mm Cannulated Conical Screw 50mm Long	00-2359-010-27	2.7mm Locking Screw 10mm Long
00-2359-055-37	3.5mm Cannulated Conical Screw 55mm Long	00-2359-012-27	2.7mm Locking Screw 12mm Long
00-2359-060-37	3.5mm Cannulated Conical Screw 60mm Long	00-2359-014-27	2.7mm Locking Screw 14mm Long
00-2359-065-37	3.5mm Cannulated Conical Screw 65mm Long	00-2359-016-27	2.7mm Locking Screw 16mm Long
00-2359-070-37	3.5mm Cannulated Conical Screw 70mm Long	00-2359-018-27	2.7mm Locking Screw 18mm Long
00-2359-012-35	3.5mm Locking Screw 12mm Long	00-2359-020-27	2.7mm Locking Screw 20mm Long
00-2359-014-35	3.5mm Locking Screw 14mm Long	00-2359-022-27	2.7mm Locking Screw 22mm Long
00-2359-016-35	3.5mm Locking Screw 16mm Long	00-2359-024-27	2.7mm Locking Screw 24mm Long
00-2359-018-35	3.5mm Locking Screw 18mm Long	00-2359-026-27	2.7mm Locking Screw 26mm Long
00-2359-020-35	3.5mm Locking Screw 20mm Long	00-2359-028-27	2.7mm Locking Screw 28mm Long
00-2359-022-35	3.5mm Locking Screw 22mm Long	00-2359-030-27	2.7mm Locking Screw 30mm Long
00-2359-024-35	3.5mm Locking Screw 24mm Long	00-2359-032-27	2.7mm Locking Screw 32mm Long
00-2359-026-35	3.5mm Locking Screw 26mm Long	00-2359-034-27	2.7mm Locking Screw 34mm Long
00-2359-028-35	3.5mm Locking Screw 28mm Long	00-2359-036-27	2.7mm Locking Screw 36mm Long
00-2359-030-35	3.5mm Locking Screw 30mm Long	00-2359-038-27	2.7mm Locking Screw 38mm Long
00-2359-032-35	3.5mm Locking Screw 32mm Long	00-2359-040-27	2.7mm Locking Screw 40mm Long
00-2359-034-35	3.5mm Locking Screw 34mm Long	00-2359-042-27	2.7mm Locking Screw 42mm Long
00-2359-036-35	3.5mm Locking Screw 36mm Long	00-2359-044-27	2.7mm Locking Screw 44mm Long
00-2359-038-35	3.5mm Locking Screw 38mm Long	00-2359-046-27	2.7mm Locking Screw 46mm Long
00-2359-040-35	3.5mm Locking Screw 40mm Long	00-2359-048-27	2.7mm Locking Screw 48mm Long
00-2359-042-35	3.5mm Locking Screw 42mm Long	00-2359-050-27	2.7mm Locking Screw 50mm Long
00-2359-044-35	3.5mm Locking Screw 44mm Long	00-2359-052-27	2.7mm Locking Screw 52mm Long
00-2359-046-35	3.5mm Locking Screw 46mm Long	00-2359-054-27	2.7mm Locking Screw 54mm Long
00-2359-048-35	3.5mm Locking Screw 48mm Long	00-2359-056-27	2.7mm Locking Screw 56mm Long
00-2359-050-35	3.5mm Locking Screw 50mm Long	00-2359-058-27	2.7mm Locking Screw 58mm Long
00-2359-052-35	3.5mm Locking Screw 52mm Long	00-2359-060-27	2.7mm Locking Screw 60mm Long





**DISCLAIMER:**

This documentation is intended exclusively for physicians and is not intended for laypersons. Information on the products and procedures contained in this document is of a general nature and does not represent and does not constitute medical advice or recommendations. Because this information does not purport to constitute any diagnostic or therapeutic statement with regard to any individual medical case, each patient must be examined and advised individually, and this document does not replace the need for such examination and/or advise in whole or in part.

**Please refer to the package inserts for important product information, including, but not limited to, indications, contraindications, warnings, precautions, and adverse effects.**

Contact your Zimmer representative or visit us at [www.zimmer.com](http://www.zimmer.com)

The CE mark is valid only if it is also printed on the product label.

