



Comprehensive[®] Segmental Revision System

Proximal Humeral Reconstruction
Distal Humeral Reconstruction
Total Humeral Reconstruction

Surgical Technique



Table of Contents

System Overview	2-5
Proximal Humeral Reconstruction	6
Pre-Operative Planning.....	6
Patient Positioning and Surgical Incision	6
Proximal Humeral Preparation	7-11
Reverse Shoulder Glenoid Preparation	12-21
Reverse Shoulder Humeral Trialing.....	22
Humeral Assembly.....	23-25
Humeral Implantation	26
Reverse Shoulder Final Assembly and Reduction.....	27-28
Total Shoulder Glenoid Preparation.....	29-32
Total Shoulder Glenoid Trialing.....	33
Total Shoulder Glenoid Implantation	33
Total Shoulder Humeral Trialing	34
Total Shoulder Humeral Assembly.....	34-35
Total Shoulder Final Assembly and Reduction	35
Distal Humeral Reconstruction	36
Pre-Operative Planning.....	36
Patient Positioning and Surgical Incision	37-38
Distal Humeral Preparation	38-42
Ulnar Preparation.....	42-47
Trialing.....	47-48
Humeral Assembly.....	49-52
Ulnar Assembly.....	53-54
Ulnar Implantation	55-56
Humeral Implantation	56
Final Assembly and Reduction	57-58
Total Humeral Reconstruction	59
Pre-Operative Planning.....	59
Patient Positioning and Surgical Incision	59
Preparation and Trialing	
Final Assembly and Implantation.....	60-61
Ordering Information	62
Implants	62-64
Instrumentation	65-74
Indications/Contraindications	75

System Overview

The Comprehensive Segmental Revision System components were designed to create a proximal, distal and total humeral replacement.

Proximal Humeral Replacement

The Comprehensive SRS proximal humeral components are often used in cases of bone loss. The proximal humeral components work in conjunction with humeral head and glenoid options from the Comprehensive Total Shoulder system.

The proximal humerus replacement components are:

- Proximal humeral bodies
- Intercalary segments (if required)
- Humeral stems
- Tissue attachment augments* (if required)



Distal Humeral Replacement

The Comprehensive SRS distal humeral system components are intended for elbow replacement in cases where there is distal humeral bone loss. The system components work in conjunction with the Nexel® Elbow ulna components and are connected through the use of the Nexel bearing kit.

The distal humeral replacement components are:

- Distal humeral body with a modular Flange
- Intercalary segment (if required)
- Tissue attachment augments* (if required)
- Humeral stems

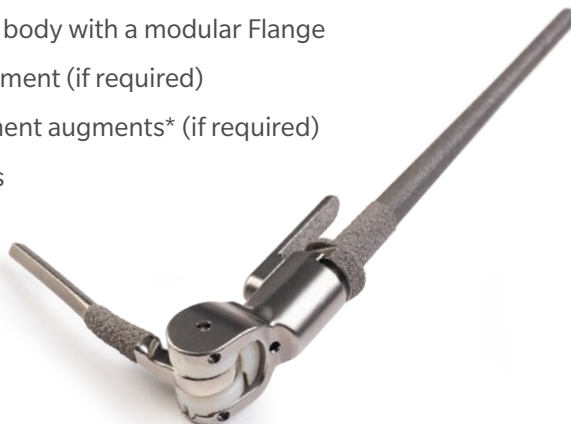

Total Humeral Replacement

The Comprehensive SRS total humeral replacement system components allow for standard total or proximal humeral reconstruction attached to a total elbow reconstruction where the humeral bone loss is so extensive that the entire humerus requires replacement. Proximally, the device is designed to work in conjunction with either the Comprehensive SRS Super Extended Articular Surface Head, or the Comprehensive Total and Reverse shoulder systems. Distally, the device works in conjunction with the Nexel Elbow ulna components through the use of the Nexel bearing kit.

The total humeral replacement system components include:

- Proximal humeral bodies
- Intercalary segments (if required)
- Total humerus coupler
- Tissue attachment augments* (if required)
- Distal humeral body



*PPS Augments are not indicated for Reverse applications.

Comprehensive Segmental Revision System Component Descriptions

Proximal Body

The Comprehensive SRS proximal bodies are available in 3 distinct designs designated as Small Revision, Large Revision and Tumor. All styles are available in 3 sizes, defined by the height of the replacement. The Small Revision and Large Revision bodies feature an anatomical lateral offset designed to help restore the natural shoulder anatomy. The tumor body has a zero lateral offset designed to avoid soft tissue irritation in circumstances where large amounts of soft tissue have been resected. The proximal bodies feature a polished finish with placement locations for the small Titanium Augments* providing optional soft tissue re-attachment during surgery.

The Comprehensive SRS proximal bodies feature a neck angle and female taper geometry identical to other Comprehensive shoulder components providing compatibility with all Comprehensive Total and Reverse Shoulder Systems.



Tumor Bodies	Small Revision Bodies	Large Revision Bodies
51 mm	48 mm	42 mm
61 mm	58 mm	52 mm
71 mm	68 mm	62 mm

Intercalary Segments

The Comprehensive SRS intercalary segments attach to either the proximal humeral body or distal humeral body to provide additional extramedullary replacement length. The anti-rotation segment is dovetailed to accept the modular flange, designed to provide rotational stability. The Intercalary Segments are available in lengths of 30 mm, 60 mm, 90 mm and 120 mm. The 60, 90 and 120 mm segments provide placement locations for the Titanium augments* providing optional soft tissue reattachment during surgery.

Caution: Tissue attachment augments* cannot be used with the 30 mm intercalary segment.

Intercalary Segments

- 30 mm
- 60 mm
- 90 mm
- 120 mm
- Total Coupler (100 mm)
- 30 mm Flange Option



Total Humerus Coupler

The total humerus coupler reconstructs approximately 100 mm of bone and is 19 mm in diameter. It incorporates a male taper at each end to attach to a proximal body and distal body, with or without an intercalary segment to replace the entire humerus. Similar to the intercalary segments, there are attachment sites for tissue attachment augments*.

Total Coupler

- Total Coupler (100 mm)



*PPS Augments are not indicated for Reverse applications.

Comprehensive Segmental Revision System Component Descriptions (cont.)

Tissue Attachment Augments*

The Comprehensive Segmental Revision System offers modular soft tissue attachment augments which can be used in conjunction with either the proximal bodies or the intercalary segments. These modular soft tissue attachment augments provide for optional tissue stabilization and attachment to either the proximal body or intercalary segments. When flipped 180 degrees, the tissue attachment augments provide additional anterior or posterior coverage due to the off-centered hole location. Suture holes in the augments provide for immediate fixation. The augments are available in both large and small configurations.

IMPORTANT: Information on Tissue Reattachment Augment Compatibility and Orientation:

Component	Augment Small	Augment Large
Small Revision Body 48 mm	YES	NO
Small Revision Body 58 mm	YES	NO
Small Revision Body 68 mm	YES	NO
Large Revision Body 42 mm	YES	NO
Large Revision Body 52 mm	YES	NO
Large Revision Body 62 mm	YES	NO
Tumor Body 51 mm	YES*	NO*
Tumor Body 61 mm	YES*	NO*
Tumor Body 71 mm	YES*	NO*
Distal Body L/R 50 mm	NO	NO
Distal Body L/R 60 mm	NO	NO
Distal Body L/R 70 mm	NO	NO
Intercalary Segment 30 mm	NO	NO
Intercalary Segment 60 mm	YES**	YES**
Intercalary Segment 90 mm	YES***	YES***
Intercalary Segment 120 mm	YES****	YES****
Total Coupler 140 mm	YES*****	YES*****
Intercalary Segment Flange 30 mm	NO	NO

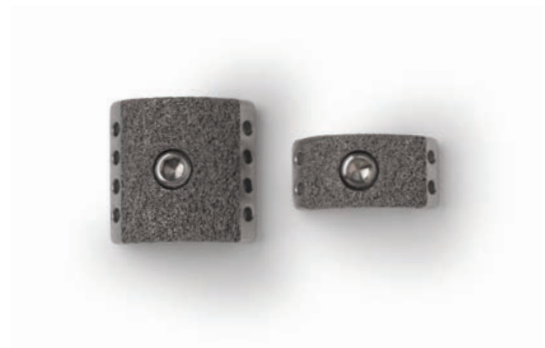

*Only the small augments can be used on the proximal bodies. When using the tumor style body with a 48 mm or 54 mm Super EAS™ heads, both the small or large augments can be used (see chart for details). Augments should NOT be placed on the medial side of the tumor style proximal bodies when the bodies if the Super EAS head diameter is smaller than 48 mm.

**When using the 60 mm intercalary segment, either two small augments can be used in a series or a single large augment can be used in either placement location unless consecutive sites are used in which case augments MUST alternate between small and large augment sizes.

***When using the 90 mm intercalary segment, large augments can be placed at attachment sites unless consecutive sites are used in which case augments must alternate between small and large augment sizes.

****When using the 120 mm intercalary segment there are 5 possible locations for augment attachment:

The 3 holes closest to the male taper accept either small or large augments. If consecutive holes are used, augments must alternate between small and large sizes.

The 2 holes closest to the female taper, use two consecutive small augments or a single large augment in the hole closest to the female taper.

*****When using the total humeral coupler, large construct augments can be placed at any of the placement locations unless consecutive sites are used in which case augments must alternate between small and large augment sizes.

Super EAS Extended Articular Surface Head

The Super EAS Extended Articular Surface Heads are designed for use with the Tumor Proximal Bodies. These heads combined with the tumor body allows for medialization without losing any contact surface on the glenoid. Super EAS heads are available in diameters of 40, 44, 48 and 54 mm.



Super Extended Articular Surface Heads (mm)

- 40 x 15
- 44 x 17
- 48 x 19
- 54 x 22

*PPS Augments are not indicated for Reverse applications.

Comprehensive Segmental Revision System Component Descriptions (cont.)

Distal Humeral Body and Stability Flange

The distal humeral bodies are designed for use in cases where there is distal bone loss requiring total elbow replacement. The distal bodies connect to ulnar components and bearing condyles to create a hinged elbow replacement.

A modular flange can be assembled to the distal humeral body designed to provide an extramedullary means to stabilize the bone/cement/implant interface. The distal humeral bodies are available in left and right configurations and in three sizes. Stability flanges are available in large and small sizes.

IMPORTANT: When using an 8 mm diameter stem or smaller, the small flange should be utilized. Large flanges should be used for stem diameters larger than 8 mm, up to and including 12 mm.



Distal Bodies

Left	Right
50 mm	50 mm
60 mm	60 mm
70 mm	70 mm

Humeral Stems

The Comprehensive SRS system’s intramedullary humeral stems allow for fixation into the remaining humeral bone. Stems are available in diameters ranging from 4 to 20 mm and lengths of 75, 100, 150, and 200 mm. The stems feature a tapered asymmetric profile for anatomic fit and rotational stability. The terminal portion of the humeral stems (including the stem ledge) is porous coated for biological fixation in shoulder applications and cement adherence in both proximal humeral and elbow applications. The distal portion of the humeral stems is grit blasted.

The stems, proximal bodies, intercalary segments and distal bodies connect to each other via a taper junction and locking screws.

Note: For press-fit stem applications select a stem size identical to the final broach/stem trial. For cemented applications select a stem that is 2 mm in diameter smaller than the final broach/stem trial.



Stem Lengths (mm)	75	100	150	200
SRS Stem	6	6	4	6
Diameters (mm)	8	8	6	8
	9	9	8	9
	10	10	9	10
	11	11	10	11
	12	12	11	12
	14	14	12	14
	16	16	14	
	18	18	16	
	20			

Proximal Humeral Reconstruction



Figure 1



Figure 2

Pre-operative Planning

Based on patient indications and selected surgical procedure, choose the appropriate treatment options. If available, utilize templates TMP405250 to aid with determining the reconstruction length options.

Tip: Final implant selection frequently cannot be made until the actual time of surgery, however, with appropriate planning a consistent operative plan with alternatives can be formulated.

Implant Construction Length

The overall replacement length required is measured from the center of the anatomic neck to the resection level. Total implant reconstruction length can be determined by adding the proximal body length and intercalary segment length (if used). The stem ledge is accounted for in the proximal body length (Figure 1).

Patient Positioning and Surgical Incision

Surgical Position

The arm and shoulder are prepped and draped free. Utilize a modified beach chair position.

Surgical Incision

Utilize an extended deltopectoral anterior incision with an optional biceps tenodesis beginning immediately above the coracoids process and extending distally and laterally, following the deltopectoral groove along the anterior border of the deltoid (Figure 2). Laterally retract the deltoid muscle, avoiding release of the deltoid from the clavicle. The deltoid may be partially released from its distal insertion by subperiosteal dissection.

Proximal Humeral Reconstruction

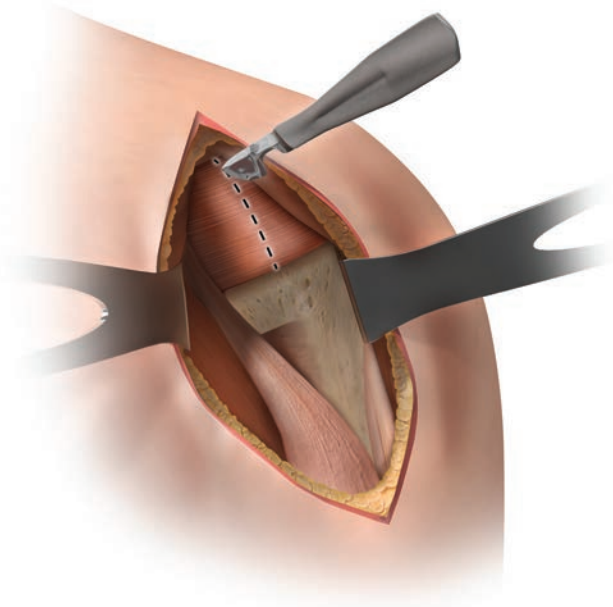

Figure 3



Figure 4

Patient Positioning and Surgical Incision (cont.)

Surgical Incision

Identify anterior structures and externally rotate the humerus. Make a longitudinal incision through the tendinous portion of the subscapularis muscle and capsule, just medial to the lesser tuberosity (Figure 3). In cases of severe contracture, subscapularis lengthening may be required.

Tag the subscapularis tendon with non-resorbable sutures. Externally rotate and extend the humerus to expose the humeral head, while protecting the axillary nerve.

Proximal Humeral Preparation

Utilize the X-ray templates TMP405250 to determine the desired resection length. Utilizing the resection template, measure the desired resection length and make anterior and longitudinal reference marks with either a cautery device or methylene blue marker (Figure 4).

The measurements specified with the proximal bodies are defined as the distance from the center of the anatomic neck to the resection level. If using an intercalary segment, the amount of additional reconstruction required is labeled. For example, a 30 mm segment adds 30 mm to the total construct length.

Proximal Humeral Reconstruction



Figure 5



Figure 6

Proximal Humeral Preparation (cont.)

Using a standard bone saw and blade, resect the bone at the resection reference mark perpendicular to the humeral axis (Figure 5).

Medullary Canal Reaming

Starting with the smallest diameter cylindrical reamer and the ratcheting T-handle, ream in $\frac{1}{2}$ mm increments to the pre-determined depth, using the depth etching located on the side of the reamers (75 mm, 100 mm, 150 mm, and 200 mm) as a reference guide (Figure 6 and 6 inset). Increase reaming in $\frac{1}{2}$ mm increments until light cortical contact is made.

Proximal Humeral Reconstruction

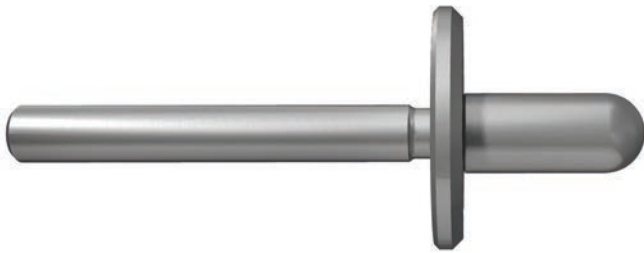

Figure 7

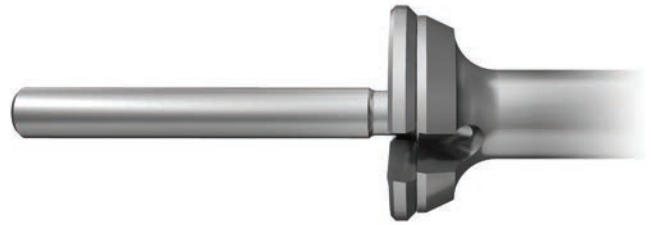

Figure 8

Proximal Humeral Preparation (cont.)

Face Planing

Measure the bi-cortical diameter at the resection level and select the appropriate sized face planer blade (38 or 54 mm). Select a face planer pilot that most closely matches the diameter of the last reamer used, ensuring the cutting surface is facing the pilot diameter and slide it into the chosen face planer blade (Figure 7).

Insert the face planer pilot and blade into the face planer base aligning the large and small posts and rotate clockwise to lock into place (Figure 8).

Proximal Humeral Reconstruction



Figure 9

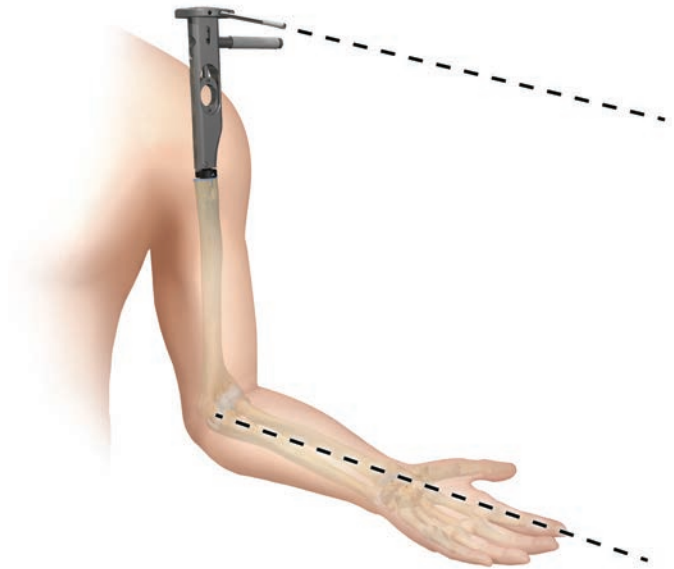

Figure 10

Proximal Humeral Preparation (cont.)

Face Planing

Utilizing a standard quick connect drill, place the assembled face planer pilot, blade and housing into the prepared medullary canal. **Begin rotation of the planer before contacting the resected surface.** Apply slight pressure and plane the resected surface, refining the resected surface to a flat cut taking caution to not over plane (Figure 9)

Broaching

Select a broach that is at least 2 to 3 mm smaller than the last cylindrical reamer used and attach it to the broach handle. Insert the version control rod into the preset holes for 20, 30, or 40 degrees of retroversion based on preoperative planning. Flex the forearm to 90 degrees, and externally rotate the arm to be parallel with the version control rod indicating the chosen amount of retroversion (Figure 10). Insert the broach handle into the prepared humerus aligning the “A” marking on the broach with the anterior reference mark on the humerus.

ⓘ **Note:** The “A” engraving on the broach indicates anterior positioning.

Proximal Humeral Reconstruction



Figure 11



Figure 12

Proximal Humeral Preparation (cont.)

Broaching

Sequentially broach in 1 mm increments. Advance broach into the humerus in several successive motions (Figure 11). The broach is fully seated when the ledge on the broach rests on the resected surface of the humerus.

- ⓘ **Note:** Note that all broaches are offered in 1mm increments while some implants are offered in 2mm increments.

Remove the broach handle, leaving the last broach in place to be used as a stem trial (Figure 12).

- ⓘ **Note:** Note: If the broach feels too tight and will not seat, finish broaching with the next smaller size.
- ⓘ **Note:** When press-fitting choose the implant that corresponds with the final size broach used. The proximal 2.5 cm of the stem is 0.25 mm circumferentially (0.5 mm total) larger than the broach allowing adequate press-fit. The remainder of the stem is line-to-line fit with the broach.
- ⓘ **Note:** When cementing choose a stem size 2 mm smaller than the diameter of the prepared canal.

Proximal Humeral Reconstruction

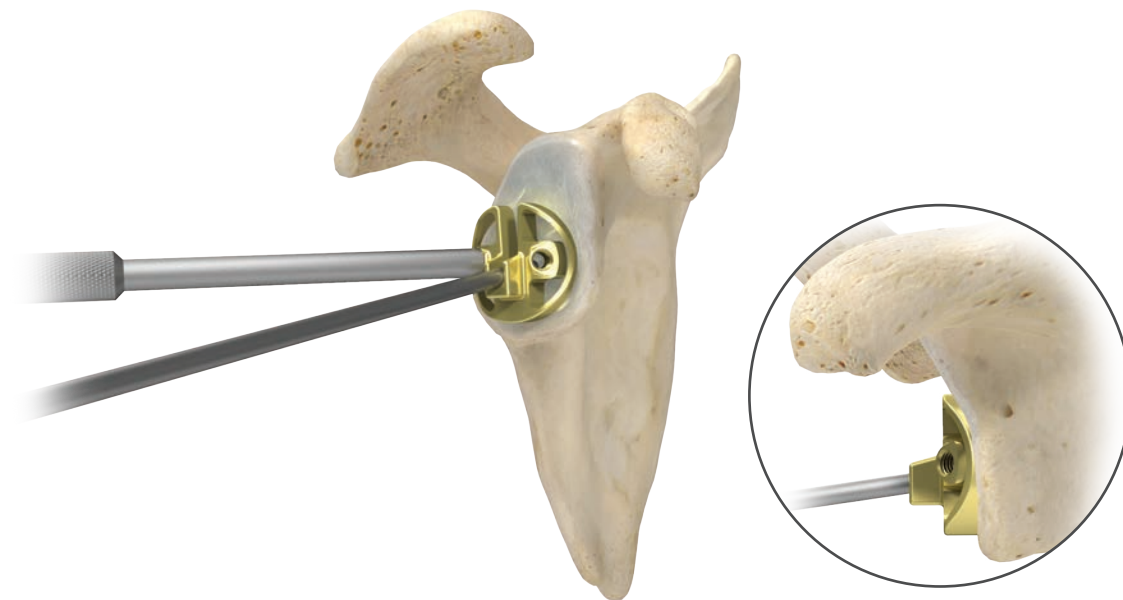

Figure 13

Reverse Glenoid Preparation

There are two baseplate options (Mini and Standard) available, each with specific instrumentation. For a breakdown of these instruments, refer to the tray layouts at the end of this Surgical Technique.

Glenoid Preparation

Attach the threaded glenoid guide handle to the glenoid sizer. Insert a 3.2 mm Steinmann pin into the glenoid at the desired angle and position, ensuring the pin engages or perforates the medial cortical wall (Figure 13). A completely secure Steinmann pin is essential to ensure the subsequent reamer has a stable cannula over which to ream. A 10 degree inferior tilt has been built into the glenoid sizer, however any glenoid defects or asymmetric wear needs to be accounted for when the Steinmann pin is placed correctly within the guide, it will lie flush with the inferior groove.

Ideally, the Steinmann pin should be placed into the best possible bone stock, keeping in mind the Versa-Dial® glenosphere can be offset up to 4.5 mm in any direction.* It may be helpful to section off the glenoid into quadrants for ease of placement of the Steinmann pin, as the best bone is often located centrally.

*For the 36 mm standard glenosphere, the offset range is 1.5–3.5 mm.

Proximal Humeral Reconstruction

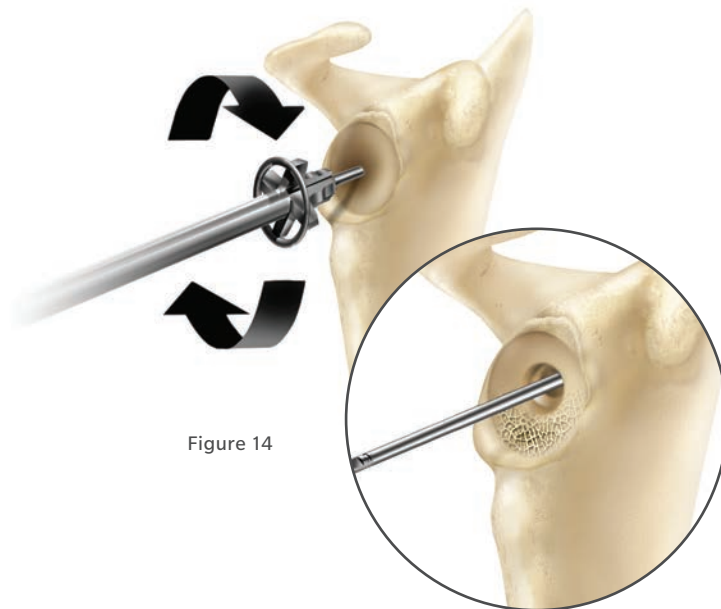

Figure 14

Figure 14a

Reverse Glenoid Preparation (cont.)

ⓘ **Note:** Obtaining a pre-operative CT scan will help identify bone erosion which may affect glenoid tilt and/ or version. It also helps locate quality bone in which to place the baseplate.

Position the cannulated baseplate reamer over the top of the Steinmann pin (Figure 14). Ream the glenoid to the desired level, ensuring the medial geometry of the glenoid baseplate is completely reamed. Due to the 10 degree inferior tilt of the Steinmann pin sizer, an inferior ridge should be evident first. A slight superior bone ridge should then follow, ensuring full concentric reaming. It is common to see cancellous bone inferiorly, while cortical bone remains superiorly. It is critical that the glenoid is adequately reamed to ensure complete seating of the glenoid baseplate (Figure 26a). Depending on the condition of the glenoid, the baseplate can be partially counter-sunk. This is accomplished by sinking the glenoid reamer until the desired inferior bone shelf is evident.

Remove the cannulated glenoid reamer, ensuring the Steinmann pin remains securely positioned in the glenoid (Figure 14a). If the Steinmann pin comes out, the baseplate trial can be used to reposition and place the Steinmann pin into the glenoid.

ⓘ **Note:** There is not a stop on the glenoid reamer, so continual attention to the reaming depth is important.

Proximal Humeral Reconstruction



Figure 15



Figure 16

Reverse Glenoid Preparation (cont.)

It is critical to remove any excess bone and soft tissue from the glenoid face (typically inferior) that may prevent complete impaction of the glenosphere/taper assembly into the baseplate. This can be done with two different methods.

Method 1: Using the cannulated trial glenoid baseplate, position the glenoid baseplate provisional over the Steinmann pin and into the prepared glenoid. If there appears to be any bone and/or soft tissue that extends past the face of the trial glenoid baseplate, utilize a rongeur to trim this unwanted bone down to ensure complete seating of the glenosphere (Figure 15).

Method 2: If the instrumentation that features the calcar planer is available, select and attach the appropriate planer blade based on the size of glenosphere desired to the planer. Position the cannulated glenoid planer over the top of the Steinmann pin. Concentrically plane the glenoid face, ensuring any adhesions and soft tissues are removed from the face of the glenoid (Figure 16). Remove the cannulated glenoid planer, ensuring that the Steinmann pin remains securely positioned in the glenoid.

If additional bone or soft tissue are present on the inferior shelf or the included planer is too large to insert into the joint space, utilize a rongeur to trim unwanted bone to ensure complete seating of the glenosphere. If the glenoid baseplate provisional does not fully seat in either of these methods, the baseplate reamer should be used to completely prepare the baseplate geometry.

Proximal Humeral Reconstruction

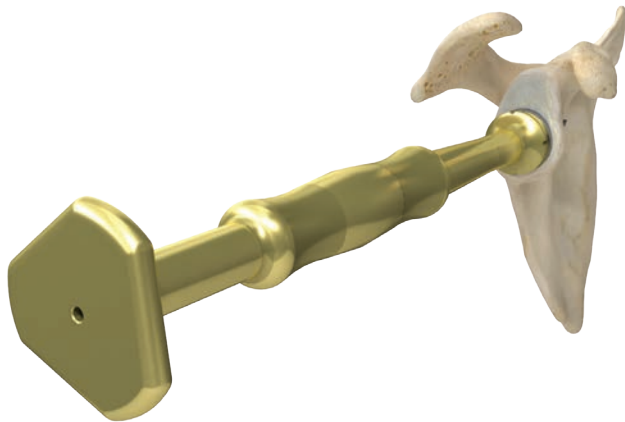

Figure 17

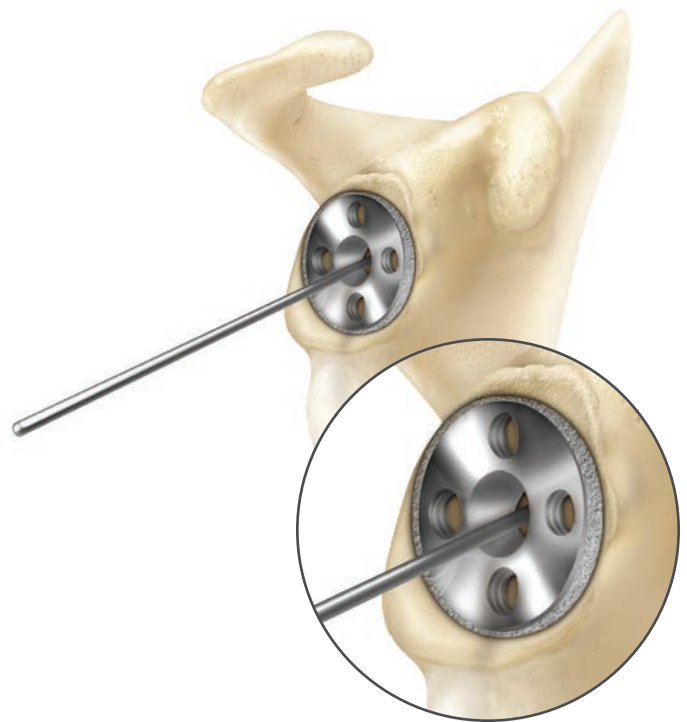

Figure 18

Reverse Glenoid Preparation (cont.)

Baseplate Impaction

Application of saline or other appropriate lubrication to impactor tip o-ring should aid in distraction of impactor from baseplate after impaction. Place the glenoid baseplate implant onto the end of the cannulated baseplate impactor (Figure 17). Reference the screw hole indicator hashmarks and grooves on the impactor to align the peripheral hole screw position as desired. All peripheral screw holes on the baseplate are identical, which allows them to be placed in any desired location. Once aligned, impact the baseplate into the glenoid and remove the baseplate impactor. The back of the baseplate should be fully seated on the face of the glenoid surface. Visual confirmation can be attained by checking for gaps between the reamed glenoid surface and baseplate at the screw holes. A small nerve hook may aid in confirming complete seating of the baseplate. Due to the 10 degree inferior to superior orientation for the baseplate preparation, the baseplate may be partially or fully counter-sunk inferiorly.

The glenoid baseplate is now seated, and determination of the appropriate length 6.5 mm central screw can be made (Figure 18).

Proximal Humeral Reconstruction

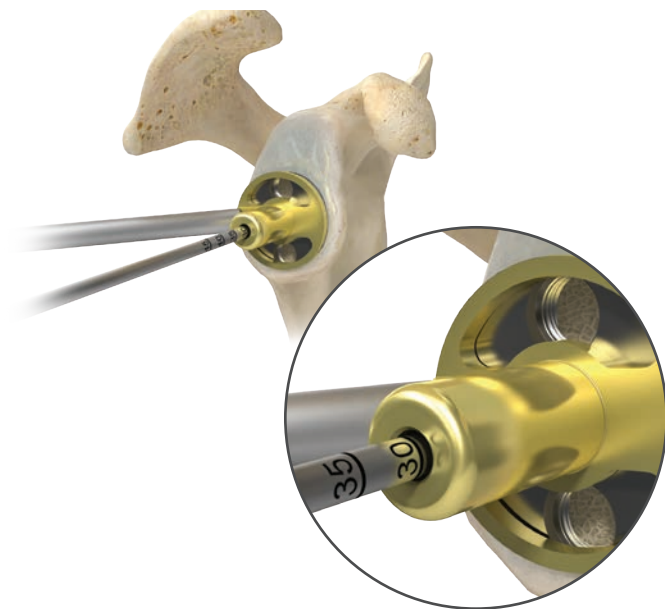

Figure 19

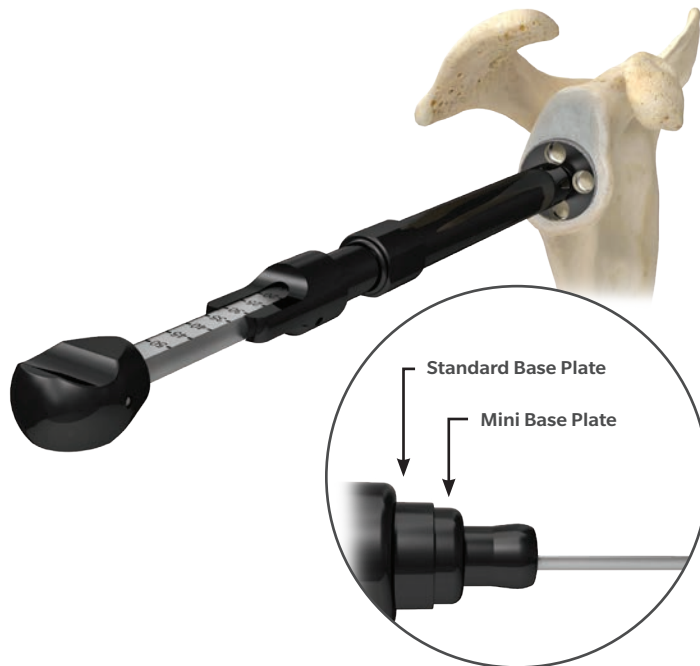

Figure 20

Reverse Glenoid Preparation (cont.)

Baseplate Central Screw Selection/Insertion

6.5 mm central screw length determination may be made in one of the three following methods:

1. With Steinmann pin in place, position the central screw drill guide over the pin and read the corresponding depth marking on the pin from the back of the drill guide (Figure 19).
2. If Steinmann pin is removed or falls out, insert the central screw drill guide into the glenoid baseplate and drill a 3.2 mm diameter hole to the desired depth. Read corresponding depth marking on the 3.2 mm diameter drill from the back of the drill guide (Figure 19 inset).
3. If Steinmann pin is removed or falls out, place the depth gauge (110025762) into the reverse Morse central taper of the glenoid baseplate and read the corresponding depth marking from the gauge (Figure 20).

ⓘ **Note:** 110025762 measures screw depth for the mini baseplate central screw, standard baseplate central screw and peripheral screws for both the mini and standard baseplates.

Proximal Humeral Reconstruction



Figure 21

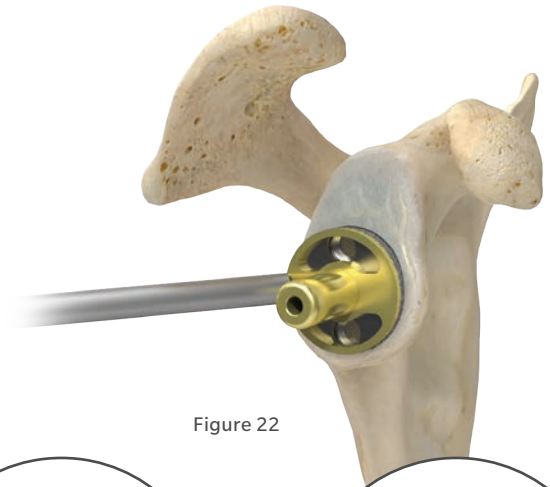

Figure 22

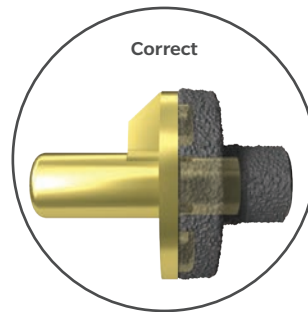

Figure 22a

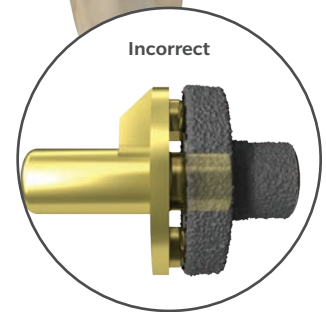

Figure 22b

Reverse Glenoid Preparation (cont.)

Insert the desired length 6.5 mm central screw (Figure 21) and completely tighten with the 3.5 mm hex driver. To verify the 6.5 mm central screw is fully seated in the baseplate, a check with the central screw drill guide should be performed. Simply attach the central screw drill guide/ template to the guide handle, and insert the guide into the reverse Morse taper of the baseplate (Figure 22). If the guide sits flush on the baseplate without rocking or toggling, the central screw is completely and correctly seated (Figure 22a).

If the guide does not sit flush, the central screw is not completely tightened. The central screw should be fully seated to achieve compression and fixation and allow for full engagement of the glenosphere taper. Additional effort should be made to inspect for unwanted soft tissue or debris behind the screw head; then fully seat the central screw. A fully seated central screw provides the best compression and fixation, as well as ensures the male taper of the glenosphere will fully engage.

Tip: The most common lengths of the central screw are 25 – 35 mm.

Proximal Humeral Reconstruction

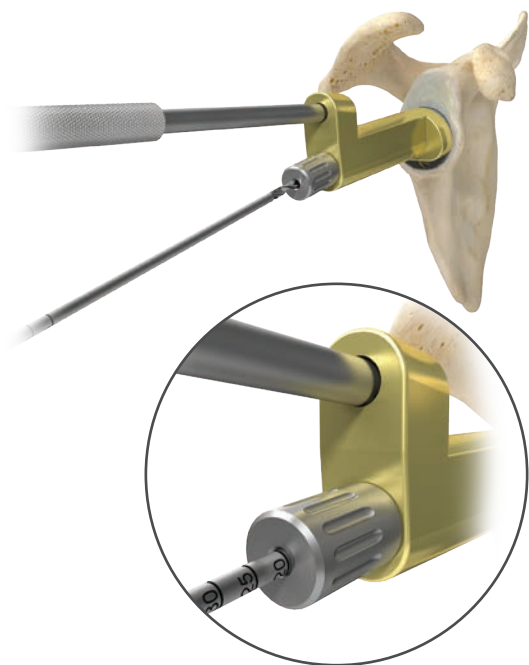

Figure 23



Figure 24

Reverse Glenoid Preparation (cont.)

Peripheral Screw Selection / Insertion

Method 1: Fixed Angle Only

Position the peripheral drill guide with bushing insert on the baseplate and drill the superior hole using 2.7 mm drill (Figure 23).

Ensure the drill bushing is flush with the guide when reading the depth markings off of the drill. Remove the drill bushing insert from the guide.

Select and tighten the appropriate length 4.75 mm screw through the channel in the drill guide using the 3.5 mm hex driver, and into the baseplate without completely tightening (Figure 24). Rotate the peripheral drill guide and bushing 180 degrees and repeat for opposing screw. Repeat these steps for the remaining two peripheral screws.

Warning: It is important to ensure the screw driver and screw are parallel with each other and fully engaged as you insert the screws using the included ratchet handle and driver. Do not insert screws under power. Deviation from this technique may lead to stripping of the driver and screw interface. Once the screws are fully seated in the baseplate, do not over-tighten.

Note: It is advisable to inspect all screw drivers after each surgery and replace as necessary.

Tighten all peripheral locking screws in an alternating fashion until fully seated to complete baseplate screw insertion (Figure 27).

Proximal Humeral Reconstruction

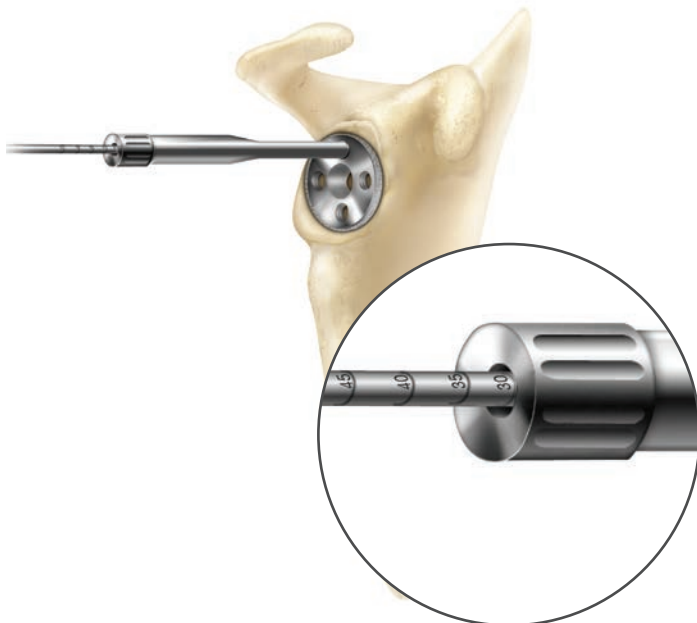

Figure 25

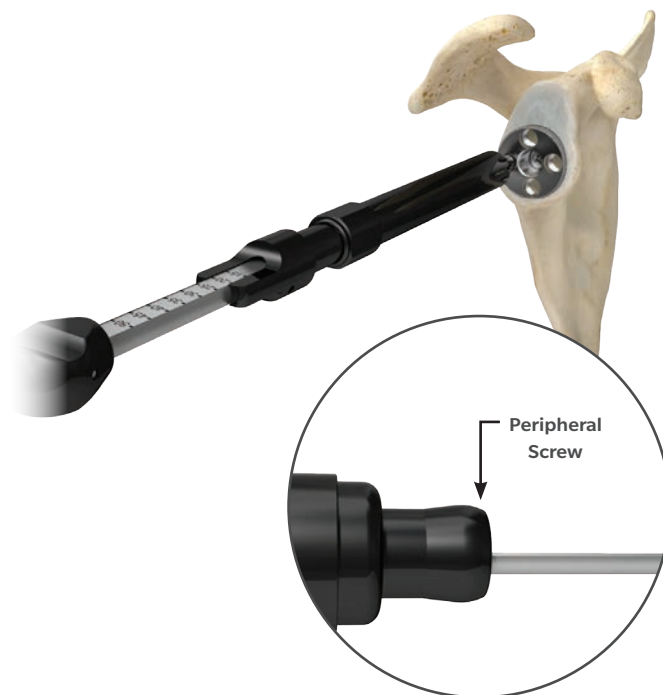

Figure 26

Reverse Glenoid Preparation (cont.)

Tip: The most common lengths of superior and inferior screws are 25 – 35 mm. The most common length of anterior and posterior screws is 15 mm. Typically, locking screws are used for all peripheral holes. However, the non-locking screws may be used to obtain compression and variability in the screw angle.

ⓘ **Note:** When used with locking screws, the baseplate peripheral holes are fixed at a 5 degree diverging angle.

ⓘ **Note:** A yellow mark has been added to the 3.5 mm hex driver to indicate when the screw is approaching the baseplate threads (when used with the captured peripheral drill / screw guide). As the yellow mark begins to disappear into the captured peripheral drill / screw guide, the screw threads are approximately 2.5 mm from completely seating. When the yellow mark can no longer be seen, the threads on the head of the screw are within approximately one complete turn of seating in the baseplate.

ⓘ **Note:** The text written on the Zimmer-Hudson connection (3.5 mm hex or 2.5 mm hex) of the peripheral drivers should be used to visually identify the type of driver.

Peripheral Screw Selection/Insertion Method 2: Fixed Angle and Variable Angle

As an alternative to using the peripheral drill guide with bushing insert, the peripheral drill guides (fixed angle or variable angle) which thread into each baseplate peripheral hole may be used. The threaded peripheral drill guide is threaded into the baseplate (Figure 25). With the 2.7 mm peripheral drill bit, drill the superior hole and read the desired depth marking at the end of the drill guide. Unscrew the threaded peripheral drill guide from the baseplate, and insert the appropriate peripheral screw. Repeat until all four peripheral screws are inserted, and fully tighten in an alternating fashion (Figure 27).

Proximal Humeral Reconstruction

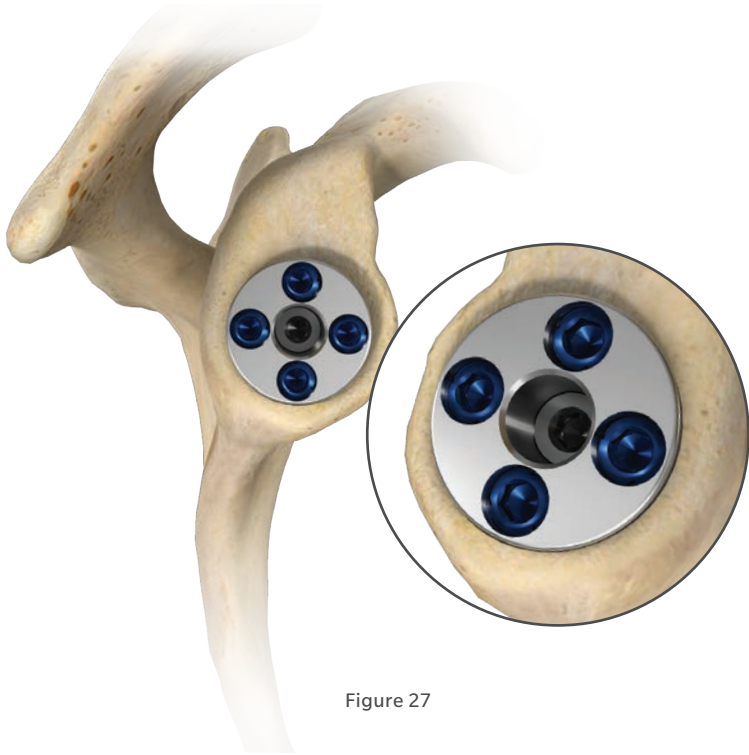

Figure 27

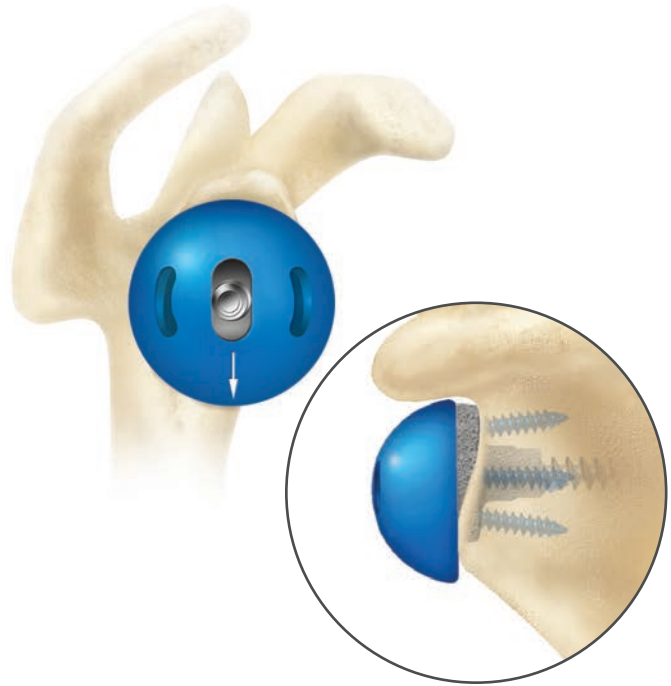

Figure 28

Reverse Glenoid Preparation (cont.)

- ⊖ **Note:** If using the variable-angle threaded peripheral drill guide, the non-locking 4.75 mm peripheral screw must be used. Six degrees of angulation in any direction is possible.
- ⊖ **Note:** If using the fixed-angle threaded peripheral drill guide, either the locking or non-locking 4.75 mm peripheral screws may be used.
- ⊖ **Note:** 110025762 measures screw depth for the mini baseplate central screw, standard baseplate central screw and peripheral screws (Figure 26) for both the mini and standard baseplates.

Glenosphere Selection

Select the appropriately sized glenosphere trial and assemble to a trial taper adaptor. Determine the amount and orientation of glenosphere offset, keeping in mind that a fully inferior offset glenosphere provides the best opportunity to minimize or eliminate scapular notching (Figure 28). However, it is possible to orient the glenosphere offset in any direction including anterior/ posterior, which may help with instability. Glenosphere provisionals are marked with an arrow to show offset direction.

In addition to the amount and direction of offset, medialized or lateralized center of rotation glenospheres (+3 mm, +6 mm) are available depending on preference.

Tip: The most common glenospheres used are 36 mm.

Proximal Humeral Reconstruction



Figure 29

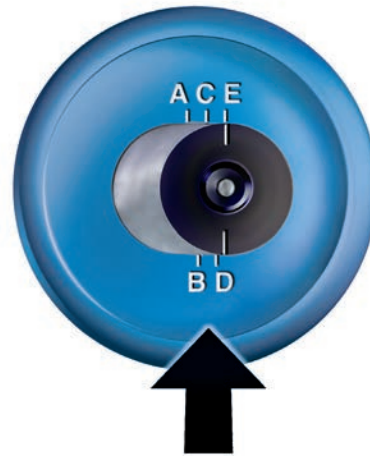

Figure 30

Reverse Glenoid Preparation (cont.)

After desired positioning of glenosphere trial is achieved, tighten the taper adaptor trial in the head trial with the appropriate hex driver (Figure 29).

- ⓘ **Note:** It may be helpful to use the trial glenosphere wrench for insertion and rotation of the trial glenosphere.
- ⓘ **Note:** An optional glenosphere trial inserter exists to be used in conjunction with the slots located on the articulating surface of the glenosphere trial to aid in the removal of the trial.

Glenosphere Offset

Remove the glenosphere trial assembly from the glenoid baseplate. Determine the amount of offset needed by referencing the A, B, C, D, and E * indications on the underside of the trial glenosphere and trial adaptor (Figure 30). This offset indicator will be referenced when preparing the definitive implant.

- ⓘ **Note:** The glenosphere removal fork may be required to remove the trial glenosphere from the glenoid baseplate.
- ⓘ **Note:** The glenosphere offset may be positioned in any orientation relative to the glenoid baseplate, keeping in mind that an inferior offset provides the best opportunity to minimize scapular notching.

*The 36 mm standard glenosphere provisional is marked with B, C, D indications as the offset range is 1.5 mm to 3.5 mm for the definitive implant.

Proximal Humeral Reconstruction



Figure 31

Reverse Shoulder Humeral Tray and Bearing Trialing

Humeral Tray and Bearing Preparation

Select the appropriately sized one-piece trial humeral tray/bearing. Noting the “SUPERIOR” and “INFERIOR” markings on the humeral tray, place the trial humeral tray/bearing into the Comprehensive broach/trial (Figure 31) and perform a trial reduction to assess range of motion and implant size selection.

The included shoe horn may be helpful in reducing the joint. The trial reduction should show very limited distraction (1 mm or less).

Note: White dimples on the proximal bodies represent potential locations for augments*. Please see the “Important Information on Tissue Reattachment Compatibility and Orientation” in the opening pages of this Surgical Technique for more information.

Note: When trialing the 30 mm anti-rotation intercalary segment for proximal humeral reconstructions, first confirm that the anterior marking on the final broach aligns with the anterior mark made on the humerus previously. Then connect the 30 mm anti-rotation intercalary segment trial to the broach such that the modular flange is also anterior. The proximal body or standard intercalary segment trial can then be connected in one of two positions on the anti-rotation segment trials for the appropriate side (either left or right).

In cases of extreme instability, +3 mm retentive humeral bearings are available. Retentive bearings capture more of the glenosphere and have polyethylene walls which are 2–3 mm higher than standard +3 mm bearings, but do not add any additional joint space.

Note: Glenospheres and humeral bearings have been color coded to ensure only matching curvatures are used together.

Tip: The most common thickness of the tray and bearing is standard for each (STD-STD).

*PPS Augments are not indicated for Reverse applications.

Proximal Humeral Reconstruction



Figure 32



Figure 33

Proximal Body Implant Assembly and Impaction

Note: The tab on the segment or proximal body should cover the flat on the stem marked with the affected side. For example, when the right proximal humerus is being constructed, cover the ‘R’ marking on the stem flat with the tab on the segment or proximal body.

Proximal Body to Stem Assembly

Utilizing the 2.5 mm 10 lb. torque drive, tighten the preassembled conical stem screw into the selected stem, ensuring that the conical stem screw is properly seated (Figure 32).

Proximal Body to Stem Assembly

There are specific proximal body impactors for each of the 3 proximal body designs. Snap the appropriate (Small Revision, Large Revision or Tumor Style) proximal body impactor onto the impactor handle. Place the impactor/impactor handle over the proximal aspect of the proximal body and impact the proximal body to the stem or segment using the proximal body impaction base with 3 or more firm strikes from a heavy mallet (Figure 33).

IMPORTANT: Do not use proximal body inserter for impaction.

Revision of Humeral Stem

In cases of revision the set is equipped with a Stem to Trial Adapter (405227). This can be assembled directly to a fixated stem and becomes the equivalent of a 30 mm segment. If no segment is being used in the construct then there is no way to fixate a proximal body trial directly onto a stem implant. If using a segment larger than the 30 mm Stem to Trial Adapter then just add the length of the Adapter to the construct (example: 30 mm Adapter + 30 mm Segment Trial = 60 mm Segment)

The set is also equipped with a stem extractor. This can be attached to a fixated stem via the 3.5 mm hex driver and then extracted using a Comprehensive Slap Hammer.

Proximal Humeral Reconstruction



Figure 34



Figure 35



Figure 36

Proximal Body Implant Assembly and Impaction (cont.)

Utilizing the 2.5 mm 10 lb. torque driver, advance the 2.5 mm side-access locking screws that are pre-assembled with the proximal body into the anterior and posterior sides of the proximal body/stem taper junction until firmly seated against the internal conical stem screw (Figure 34). Side access screws are pre-assembled with proximal bodies and intercalary segments. These screws should be advanced to lock the taper junction after all components have been assembled and impacted.

Proximal Body to Segment and Stem Assembly

Utilizing the 2.5 mm 10 lb. torque driver, hand tighten the conical stem screw in the selected stem, ensuring that the conical stem screw is properly seated (Figure 31).

Stem Selection

For press-fit stem applications select a stem size identical to the final broach/stem trial. For cemented applications select a stem that is 2 mm in diameter smaller than the final broach/stem.

Intercalary Segment to Stem Assembly (where required)

Utilizing the 2.5 mm 10 lb. torque drive, tighten the preassembled conical stem screw into the selected stem or intercalary segment (Figure 35), ensuring that the conical stem screw is fully seated. Impact the stem and intercalary segment using the impaction base and taper impactor with 3 or more firm strikes from a heavy mallet (Figure 36).

IMPORTANT: It is critical that both male and female tapers are perfectly clean and dry before impaction. This applies to all taper junctions in the construct.

ⓘ **Note:** If the deltoid tendon has been detached during the procedure, it must be secured to the SRS construct using either a small or large Soft Tissue Attachment Augment*.

*PPS Augments are not indicated for Reverse applications.

Proximal Humeral Reconstruction



Figure 37



Figure 38

Proximal Body Implant Assembly and Impaction (cont.)

Soft Tissue Attachment Augments* (Optional)

After implant constructs are fully assembled and implanted, properly orient the soft tissue augment implant onto the segment or proximal body, ensuring that the position of the soft tissue augment corresponds with the white dimples on the appropriate trial (proximal body or intercalary segment). Attach the modular tissue augment to the proximal body or intercalary segment using the packaged screws to 55 inch pounds by using the provided torque wrench (Figure 37).

Caution: Do not leave the torque wrench in the off position during assembly as screw damage can occur.

ⓘ **Note:** If the deltoid tendon has been detached during the procedure, it must be secured to the SRS construct using either a small or large Soft Tissue Attachment Augment.

ⓘ **Note:** Both small and large Soft Tissue Attachment Augments are available with this system. The small Soft Tissue Attachment Augments work in conjunction with the proximal bodies and the intercalary segments, per the reference chart in the opening pages of this Surgical Technique.

Proximal Body to Segment and Stem Assembly

Impact the selected intercalary segment onto the stem using the taper impactor and impaction base with three or more firm strikes from a heavy mallet.

Assemble and impact the selected proximal body to the intercalary segment following instructions in the previous section (Figure 38). The side-access locking screws should be secured against an internal conical screw at every taper junction in a proximal humeral reconstruction.

ⓘ **Note:** It is critical that both male and female tapers are perfectly clean and dry before impaction. This applies to all taper junctions in the construct.

IMPORTANT: Do not use the proximal body inserter for impaction.

*PPS Augments are not indicated for Reverse applications.

Proximal Humeral Reconstruction



Figure 39



Figure 40

Proximal Humeral Component Insertion

Use a pulse/lavage suction unit to thoroughly clean the humeral canal.

Humeral Stem Insertion - Cemented Technique

Dry the canal with absorbent gauze and inject doughy cement in a retrograde manner, completely filling the humeral canal. Place the version control rod into the appropriate version hole and align it with the forearm flexed at 90 degrees. Introduce the stem into the humeral canal until the stem ledge makes full contact with the bone at the resection level (Figures 39 & 40). Remove excess cement. Hold the device in place until cement has fully hardened prior to impaction of the head or before trialing the head again.

ⓘ **Note:** Head trials can be used with the proximal body implant to confirm appropriate joint reduction again, if desired.

Humeral Stem Insertion - Press-Fit Technique

Remove the proximal body and/or intercalary segment trials from the broach/stem trial. Attach the broach handle to the broach/trial and remove it from the humeral canal using retrograde impaction. Assemble the proximal implant construct onto the proximal body inserter. Place the version control rod into the appropriate version hole and align it with the forearm flexed at 90 degrees (Figure 33). Gently impact the entire construct until the stem ledge makes full contact with the bone at the resection level (Figures 39 & 40). If any resistance is felt during impaction, return briefly to re-broach the humeral canal.

ⓘ **Note:** The humeral stem diameter is 0.5 mm circumferentially larger than the broach for the most proximal 2.5 mm of the stem providing for a tight fitting stem in the humeral canal.

Proximal Humeral Reconstruction



Figure 41



Figure 42

Reverse Glenosphere Assembly

Glenosphere Assembly

Place the glenosphere implant into the impactor base. Ensuring the components are clean and dry, insert the taper adaptor into the glenosphere (Figure 41). Rotate the taper adaptor until the trial offset is replicated. For example, if trialing indicated a fully offset glenosphere (position E), the implant taper adaptor is aligned so that the hashmark is positioned at position E on the definitive glenosphere head.

Offset Indicator	Offset*
A	0.5 mm
B	1.5 mm
C	2.5 mm
D	3.5 mm
E	4.5 mm

*For 36 mm Standard Glenosphere, the offset range is 1.5–3.5 mm (B–D).

ⓘ **Note:** When using a construct that has compromised the deltoid attachment point, a Soft Tissue Augment* must be used to secure the deltoid tendon to the SRS construct.

*PPS Augments are not indicated for Reverse applications.

Reverse Humeral Tray and Bearing Assembly

ⓘ **Note:** In cases of extreme instability, +3 mm retentive humeral bearings are available. Retentive bearings capture more of the glenosphere and have polyethylene walls which are 2–3 mm higher than standard +3 mm bearings, but do not add any additional joint space. Depending on variations in instrument tray layouts, the retentive bearings may be found in the revision instrument tray.

ⓘ **Note:** Additional humeral resection and subsequent re-reaming and re-broaching may be required if the joint is extremely difficult to reduce.

ⓘ **Note:** Glenospheres and humeral bearings have been color coded to ensure only matching curvatures are used together.

ⓘ **Tip:** The most common thickness of the tray and bearing is standard for each (STD-STD).

Proximal Humeral Reconstruction



Figure 43



Figure 44

Reverse Humeral Tray and Bearing Impaction (cont.)

Position the definitive humeral bearing in the definitive humeral tray, ensuring that the laser etching on the bearing aligns with the laser etching on the humeral tray. This alignment assures engagement of the RingLoc locking mechanism between the tray and bearing. Snap the humeral bearing into the humeral tray (Figure 42). An audible “click” will be heard when the bearing is properly engaged.

Tip: Assembly of humeral tray and bearing may be aided by using index fingers and thumbs to compress and snap into place. It may be easier to engage the superior part of the humeral bearing and tray first, followed by the inferior side.

With two firm strikes of the humeral tray/bearing impactor, impact the assembled definitive humeral tray/bearing into the Comprehensive stem. The humeral tray is marked “SUPERIOR” to aid in positioning the tray/bearing with respect to the stem. When inserted correctly, the thicker portion of the polyethylene bearing should be inferior. Reduce the joint with the aid of the shoe horn and assess the final range of motion. The final reduction (Figure 44) should show very limited distraction (1 mm or less). Impingement should not be present in either adduction or abduction. If impingement occurs in abduction, a greater tuberosity osteotomy or tuberopectomy may be necessary.

Proximal Humeral Reconstruction

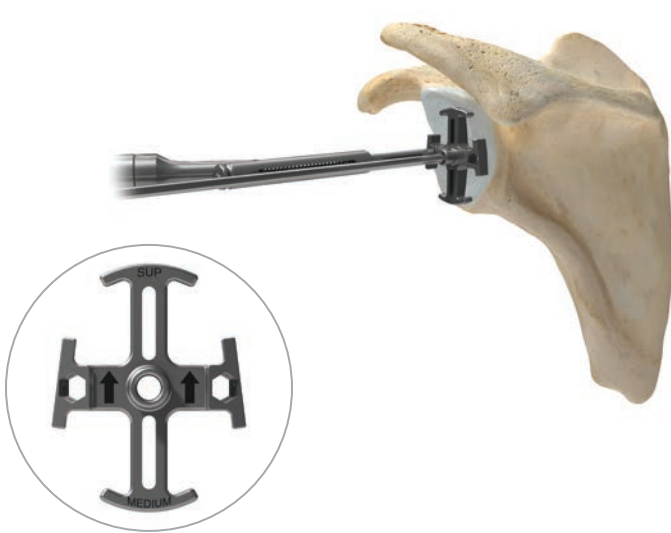

Figure 45

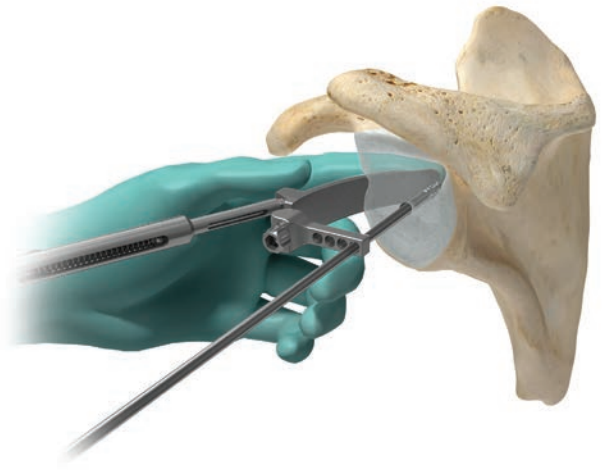

Figure 46

Total Shoulder Glenoid Preparation

Pin Placement

Based on the operative shoulder, attach the quick-connect guide handle to the appropriate Sizer Pin Guide (Figure 45). Place the sizer in the middle of the glenoid in the correct orientation. Slots in the guide are provided for visualization if the glenoid has been sectioned into quadrants by using a bovie.

Insert the 3.2 mm threaded Steinman pin through the sizer and carefully drill under power until the Steinman pin has engaged the medial cortex of the glenoid vault. Once the Steinman pin is securely placed, back the guide out over the pin and remove from the joint.

As an alternative method of placing the initial Steinman pin, the Glenoid Vault Pin Guide can be used to place the guide pin by referencing the junction of the anterior glenoid neck and the scapular body.

Attach the quick-connect guide handle to the Glenoid Vault Pin Guide. Prior to inserting into the joint, be sure that the screw is locked into place to prevent the guide hinge from moving. Insert the Glenoid Vault Pin Guide into the joint and proceed to slide the tip of the guide down the anterior wall of the glenoid until it reaches the lateral aspect of the subscapularis fossa. A finger can be used to assess the correct placement of the guide along the scapular body. Once desired placement is found, identify the pin hole that best locates the center of the glenoid and insert the 3.2 mm Steinmann pin (Figure 46).

Note: This guide will help control version, however, careful attention should be made to the inclination of the pin. Each hole in the guide will direct the Steinman pin towards the tip of the guide.

Proximal Humeral Reconstruction

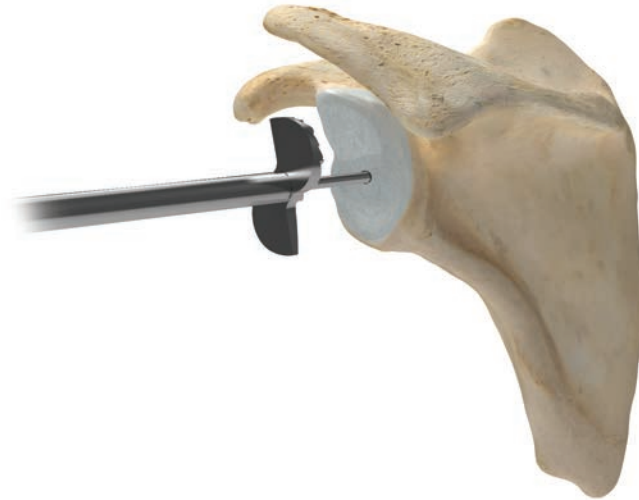

Figure 47

Total Shoulder Glenoid Preparation (cont.)

Proceed carefully under power until the medial cortex is engaged with the threaded tip of the Steinman pin. Remove the drill from the pin, leaving the pin in place. Release the pin guide by unthreading the thumb screw and back the guide out over the pin and remove from the joint. The glenoid sizer can then be placed over the pin to determine appropriate glenoid size.

Note: The Versa-Dial screw driver can be used to unthread the thumb screw if needed.

Glenoid Reaming

Choose the appropriate size Glenoid Face Reamer based off of the previous glenoid sizer. Assemble the chosen Glenoid Face Reamer with the modular handle. Insert the reamer into the joint over the pin. The glenoid should be reamed to the proper version and inclination as determined by the preoperative plan and intraoperative observation (Figure 47).

Caution: As with any reaming, it is important to start the reamer rotating prior to coming into contact with bone. This will ensure that the reamer is rotating freely and clear of any soft tissues or other instruments that may be an obstruction.

Caution: Over-reaming can decrease the surface area of the glenoid and the depth of the glenoid vault which can lead to insufficient seating or subsidence of the implant.

Proximal Humeral Reconstruction

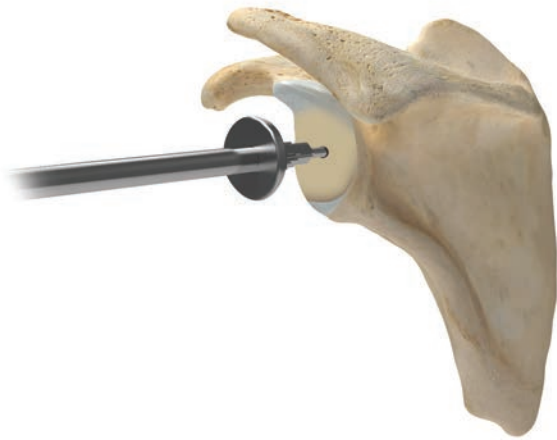

Figure 48

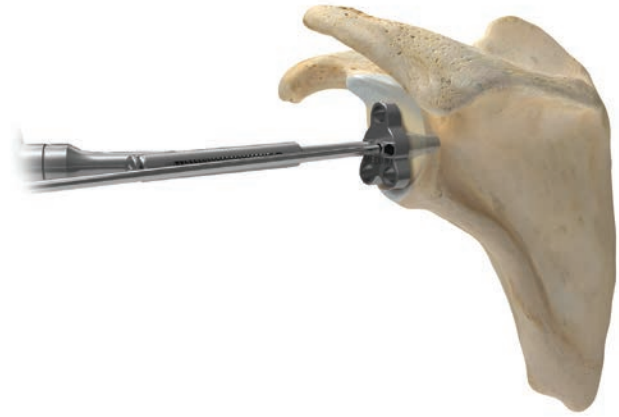

Figure 49

Total Shoulder Glenoid Preparation (cont.)

Central Post Preparation

Once the desired amount of reaming is completed, the 2-in-1 Central Post Cutter will be used to prepare for the central boss and Regenerex Central Post geometry. Insert the 2-in-1 central post cutter into the joint over the guide pin and proceed to ream until the stop is engaged against the newly reamed surface of the glenoid face (Figure 48).

Caution: As with any reaming, it is important that the central post cutter is rotating prior to coming into contact with bone to avoid any undesirable outcomes.

Peripheral Peg Preparation

Select the appropriate size Cannulated Peripheral Peg Drill Guide and attach a quick-connect guide handle. Insert the guide over the Steinman Pin and into the joint until it is fully seated against the face of the glenoid (Figure 49).

Proximal Humeral Reconstruction



Figure 50

Total Shoulder Glenoid Preparation (cont.)

Insert a quick-release drill into the quick-release driver. Drill the superior hole until the stop is engaged. Remove the driver from the joint while leaving the drill bit in place to function as an anti-rotation peg. The drill bit is connected to the driver with a magnetic connection. Once drilled, the bone will provide enough friction to retain the drill bit as an anti-rotation peg.

ⓘ **Note:** Be sure that the drill driver has stopped rotating prior to disconnecting from the drill bit/anti-rotation peg.

Insert a second quick-release drill bit into the driver and drill the anterior-inferior hole. Remove the driver from the joint while leaving the drill bit in place to function as a second anti-rotation peg. Using a third drill bit, drill the remaining posterior-inferior hole (Figure 50).

Remove the guide and alignment pins/drill bits from the joint by backing the guide and drill bits out over the Steinman pin. Remove the Steinman pin from within the joint by using the drill on reverse.

ⓘ **Note:** The standard peripheral peg drill and anti-rotation pegs can be used in place of the quick-connect drill bits if needed.

Proximal Humeral Reconstruction



Figure 51

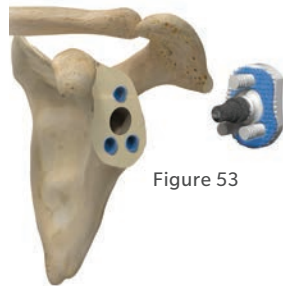

Figure 53

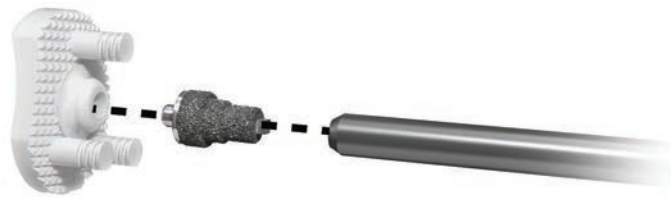

Figure 52



Figure 54

Total Shoulder Glenoid Trial Reduction

Trial Reduction

Seat the appropriate size glenoid trial firmly on the face of the glenoid (Figure 51). Ensure the trial is congruent with the reamed surface.

Reassemble the humeral head trial on the humeral broach/trial and evaluate range of motion. Make any necessary adjustments to the humeral head height and diameter to properly tension the joint.

Total Shoulder Glenoid Implantation

Remove the glenoid trial. Using a high-speed irrigation lavage system, cleanse the prepared surface. If used, thread the appropriate central peg into the modular hybrid glenoid with the central post driver (Figure 52). Digitally pressurize Colbalt bone cement into the three peripheral holes.

Based on the chosen central peg, use cement as follows: if using the polyethylene central peg, place a small amount of bone cement between the fins and the base of the central peg; if using the Regenerex Porous Titanium central peg, bone cement should not be used on the central post.

Place a thin layer of cement on the medial side of the glenoid component (Figure 53–Regenerex Porous Titanium central peg). Insert the glenoid and carefully remove any excess cement (Figure 54).

Proximal Humeral Reconstruction



Figure 55



Figure 56



Figure 57

Total Shoulder Humeral Trialing

Trialing

Position and snap the selected proximal body trial to the broach/stem trial according to the desired reconstruction length, ensuring the “A” marking on the broach/stem with the anterior marking on the prepared humerus. An audible “click” will be heard when both the tab and flat of both trials are fully aligned (Figure 55).

- ⓘ **Note:** The Comprehensive SRS proximal or distal bodies and intercalary segment trials can be placed before or after the glenoid or ulnar preparation based on surgeon preference.
- ⓘ **Note:** As an initial aid in determining the overall replacement height, choose a construct that leaves the female humeral taper parallel with the inferior face of the glenoid. Minor adjustments can then be made with a combination of changes to the humeral components, proximal bodies, segments, or additional humeral resection.

Super EAS Head Selection (Tumor Resection Applications)

Using the resected humeral head for comparison, select an appropriately sized super EAS head trial and assemble to tumor body trial. Reduce the joint and perform a trial range of motion.

Total Shoulder Humeral Assembly/Impaction

Head Size and Offset Selection

Using the resected humeral head for comparison, select an appropriately sized head trial and assemble to a standard trial taper adaptor. Determine the amount of desired offset and tighten the taper adaptor trial in the head trial with the 2.5 mm hex driver (Figure 56). Reduce the joint and perform a trial range of motion.

- ⓘ **Note:** The head trial will still rotate within the proximal body trial. The screw only locks in the desired amount of offset. It also may be advisable to mark the proximal body trial with the offset direction in order to accurately replicate the exact position when it comes to implanting the definitive humeral head. Heads can be trialed again after definitive proximal body implants are in place if desired.

Head Offset

Remove the selected head trial assembly from the proximal body trial. Determine the amount of offset needed by referencing the indications on the underside of the trial head and trial adaptor (Figure 57), keeping in mind that the offset chosen may be between letters.

Proximal Humeral Reconstruction



Figure 58

Total Shoulder Humeral Head Insertion

Head Assembly

Place the Versa-Dial head into the impactor tray. Ensuring the components are clean and dry, insert the Versa-Dial taper adaptor into the head (Figure 58). Rotate the taper adaptor until the trial offset is replicated. For example, if trialing indicated halfway between the B and C hashmarks, the implant taper adaptor is aligned so its hash mark is halfway between the B and C on the head.

Engage the Morse taper with two strikes, using the taper impactor tool and mallet (Figure 48). The taper/head assembly is now securely fastened.

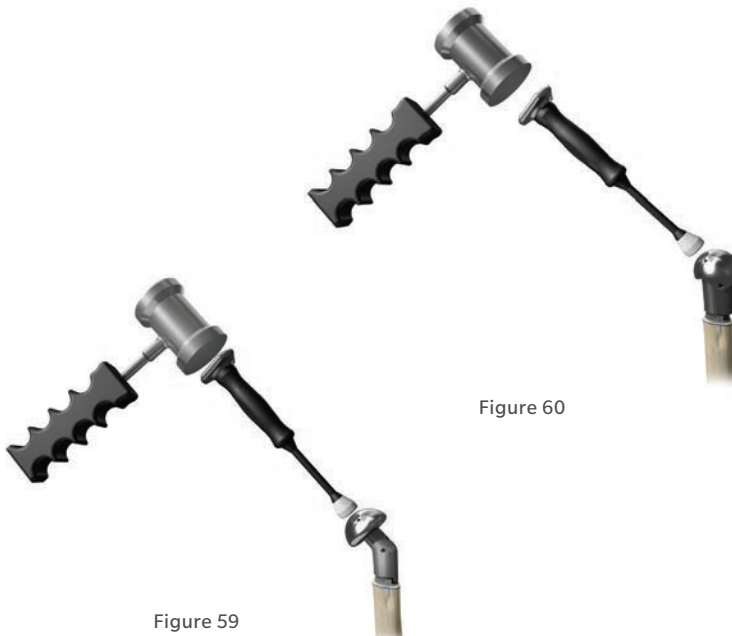

Figure 59

Proximal Humeral Component Insertion (cont.)

Humeral Head Insertion

Clean and dry the reverse Morse taper in the proximal body implant. Gently place the selected head onto the proximal body and rotate to desired orientation (Figure 59). Impact the head onto the proximal body to complete humeral head implantation by using at least two blows with an appropriately sized surgical mallet and the head impactor tool.

Humeral Head Insertion (Tumor Resection Applications)

Clean and dry the reverse Morse taper in the proximal body. Gently place the super EAS head on the proximal body. Rotate the super EAS head until the opening is directly medial.

Utilizing the Versa-Dial head impactor, impact the head on to the tumor style proximal body to complete the humeral head implantation by using two firm strikes with an appropriately sized surgical mallet and the head impactor tool (Figure 60).

Figure 60

Distal Humeral Reconstruction

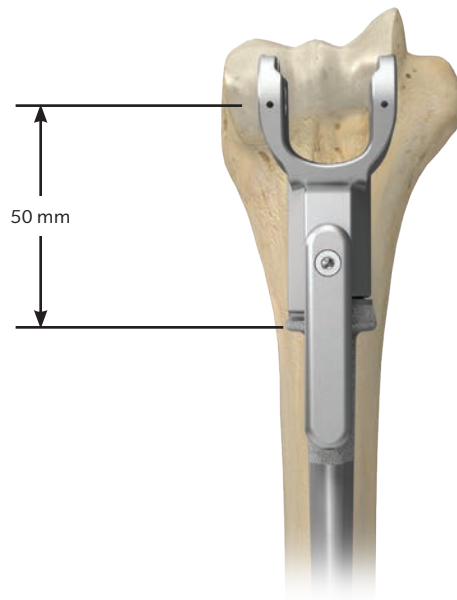

Figure 61

Pre-operative Planning

Based on patient indications and selected surgical procedure, choose the appropriate treatment options. Utilize the templates to aid with determining the reconstruction length options.

Tip: Final implant selection frequently cannot be made until the actual time of surgery, however, with appropriate planning a consistent operative plan with alternatives can be formulated.

Implant Construction Length

The overall replacement length required is measured from the axis of rotation to the resection level (Figure 61). Total implant reconstruction length can be computed by adding the distal body and intercalary segment (if used) lengths. The stem ledge is accounted for in the distal body length designation.

Distal Humeral Reconstruction



Figure 62

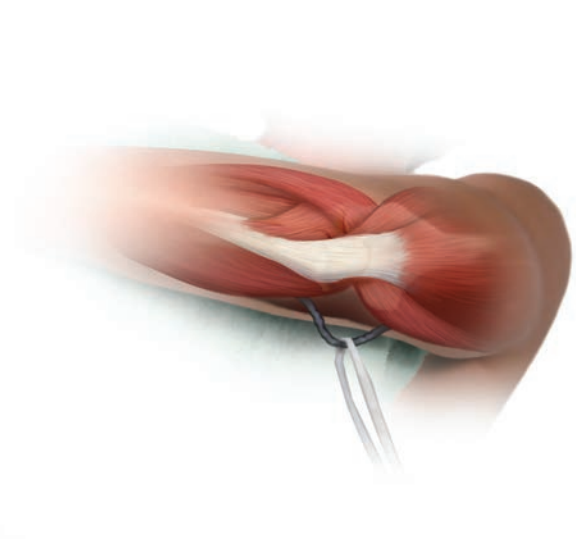

Figure 63

Patient Positioning and Surgical Incision

Surgical Positioning

Place the patient in a supine or lateral position. Lay the affected arm across the patient's chest to give access to the posterior aspect of the joint. Towels may be placed under the scapula to elevate the operative site. Drape the arm free to expose the posterior elbow and apply a tourniquet.

Surgical Incision

Make a longitudinal incision slightly lateral to the medial epicondyle and just medial to the tip of the olecranon (Figure 62).

Identify the ulnar nerve and decompress the cubital tunnel. Mobilize and carefully control the nerve along the medial/anterior border of the skin incision. Excise the intramuscular septum to ensure proper transposition of the nerve. Pay careful attention to the location of the ulnar nerve throughout the entire procedure (Figure 63). Eventual handling of the nerve should be individualized. The developing surgeons advocate anterior transposition.

Distal Humeral Reconstruction

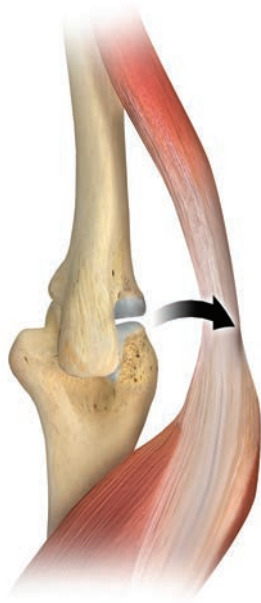

Figure 64



Figure 65

Patient Positioning and Surgical Incision (cont.)

Triceps-Off Approach

Make an incision in the fascia over the ulnar head of the flexor carpi ulnaris muscle from the cubital tunnel out to a point on the ulnar shaft 7–10 cm distal to the olecranon. Elevate the fascia over to the lateral subcutaneous border of the ulna. After anterior transposition of the ulnar nerve, carry sharp scalpel dissection down to the humerus, posterior to the intermuscular septum. Elevate the triceps proximally from the humerus with a periosteal elevator and distally from the olecranon fossa with a scalpel. Sharply elevate the triceps fibers of attachment to the ulna and mark with a 3-0 braided polyester suture to facilitate later repair. With elbow flexion, expose the joint.

Subperiosteal release of the lateral collateral ligament origin from the humerus and anterior capsulectomy provides additional exposure by allowing further flexion and supination of the forearm from the humerus (Figure 64). Attempt to preserve the integrity of the ulnar collateral ligament. However, severe elbow contractures may require proximal release of its origin for enhanced exposure.

Humeral Bone Preparation

Distal Humeral Preparation

Utilize the X-ray templates and measure from the elbow's center of rotation to the desired resection level, determining the desired resection length. Measure the desired resection length and make posterior and longitudinal reference marks with either a cautery device or methylene blue marker corresponding to a distal reconstruction length option (Figure 65).

Distal Humeral Reconstruction



Figure 66



Figure 67

Humeral Bone Preparation (cont.)

Distal Humeral Preparation

Using a standard bone saw and blade, resect the bone at the anterior reference mark perpendicular to the humeral axis (Figure 66).

Medullary Canal Reaming

Using the smallest diameter cylindrical reamer and the ratcheting T-handle, bore a ream hole through the resected surface of the humerus along the axis of the shaft and ream in $\frac{1}{2}$ mm increments to the predetermined depth, using the depth etching located on the side of the reamers (75 mm, 100 mm, 150 mm, and 200 mm) as a reference guide (Figure 67, 67 inset). Increase in $\frac{1}{2}$ mm increments until light cortical contact is made.

Distal Humeral Reconstruction

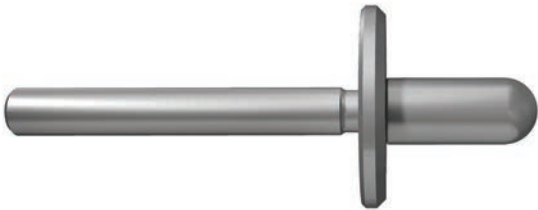

Figure 68

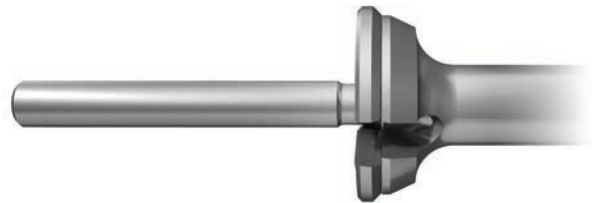

Figure 69

Humeral Bone Preparation (cont.)

Face Planing

Measure the bi-cortical diameter at the resection level and select the appropriate sized face planer blade (38 or 54 mm). Select a face planer pilot that most closely matches the diameter of the last reamer used and slide it into the chosen face planer blade (Figure 68).

Insert the face planer pilot and blade into the face planer base aligning the large and small posts and rotate clockwise to lock into place (Figure 69).

Distal Humeral Reconstruction



Figure 70



Figure 71

Humeral Bone Preparation (cont.)

Utilizing a standard quick connect drill, place the assembled face planer pilot, blade and housing into the prepared medullary canal. Begin rotation of the planer before contacting the resected surface. Apply slight pressure and plane the resected surface, refining the resected surface to a flat cut taking caution to not over plane (Figure 70).

Broaching

Select a broach that is at least 2 to 3 mm smaller than the last cylindrical reamer used and attach it to the broach handle. Insert the broach handle into the prepared humerus aligning the “A” marking on the broach with the anterior portion of the humerus.

- ⓘ **Note:** The “A” engraving on the broach indicates anterior positioning. With the posterior approach to elbow arthroplasty the “A” will face away from the incision so a landmark opposite of the “A” may be used find posterior positioning.

Sequentially broach in 1 mm increments ensuring that the canal is prepared to a diameter 2 mm larger than the implant being used to accommodate for cement. Advance broach into the humerus in several successive motions. The broach is fully seated when the ledge on the broach rests on the resected surface of the humerus (Figure 71).

- ⓘ **Note:** All broaches are offered in 1 mm increments while some implants are offered in 2 mm increments.
- ⓘ **Note:** Be aware that each broach size (1 mm increments) does not necessarily have a corresponding implant.

Distal Humeral Reconstruction



Figure 72



Figure 73

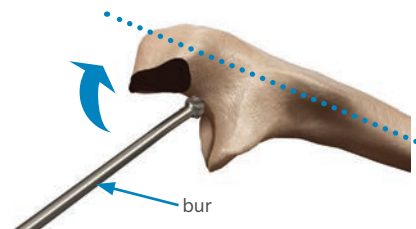

Figure 74

Humeral Bone Preparation (cont.)

Remove the broach handle, leaving the last broach in place to be used as a stem trial (Figure 72).

⊖ **Note:** If the broach feels too tight and will not seat, finish broaching with the next smaller size.

Ulnar Bone Preparation

⊖ **Note:** Be aware that instruments labeled size “5/6” can be used for a size 5 or 6 implant; likewise, instruments labeled size “4/5” can be used for a size 4 or 5 implant.

⊖ **Note:** The width of the SRS/Nexel distal humeral condyle matches that of the size 6 Nexel humeral component. This does not impact the ulna component size however as any (Size 4/5/6) ulna component can match with the size 6 humeral component.

⊖ **Note:** Excessive resection of the olecranon compromises the re-attachment of the triceps mechanism and weakens the olecranon process. Inadequate resection tilts the intramedullary Rasp causing malalignment of the Ulnar Component and risks perforation of the dorsal ulnar cortex.

Ulnar Canal Exposure

Remove the tip of the olecranon using an oscillating saw (Figure 73).

Use a high-speed bur to open the medullary canal at the base of the coronoid (Figure 74).

Distal Humeral Reconstruction



Figure 75



Figure 76

Ulnar Bone Preparation (cont.)

Ulnar Canal Reaming

Notch the olecranon using a bur or rongeur (Figure 75). The notch should be aligned and deep enough such that in-line access to the ulnar canal can be achieved with the Reamers/Rasps.

Open the canal using the Ulnar Awl Reamer (Figure 76). Place fingers along the exposed shaft of the ulna to help identify the location of the ulnar shaft distal to the coronoid to prevent violation of the cortices distally.

Distal Humeral Reconstruction



Figure 77

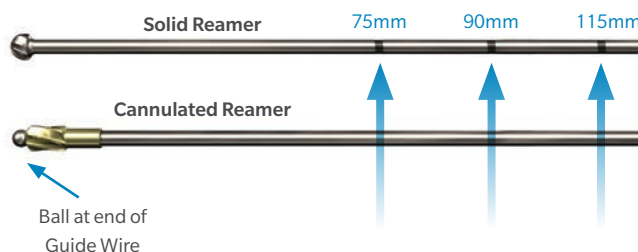

Figure 78

Ulnar Bone Preparation (cont.)

Note: Flexible Reamers must be used for ulnar canal preparation. They are used to expand the canal prior to rasping and fully prepare the distal portion of the canal for implantation. They must be used progressively beginning with the smallest 4.5mm Flexible Solid Reamer. DO NOT skip sizes, or attempt to begin with larger cutting head sizes.

Progressively ream the ulnar canal until the desired size is achieved (see table).

Start with the Flexible Solid Reamers. Ream to the depth marking (75, 90 or 115 mm) based on the desired Implant length (Figure 77).

Size Ulnar Component	Final Flexible Reamer (mm)
4	4.5
5	6.5
6	7.0

Continue reaming with Flexible Cannulated Reamers as necessary depending on chosen implant size. Use with Sterile Ball Tip Guide Wire 2.4 x 70 to avoid cortical penetration as necessary depending on chosen implant size.

Note: Flexible Cannulated Reamers do not have depth markings in order to maintain reamer shaft integrity but can be marked with a surgical marker (Figure 78).

Distal Humeral Reconstruction

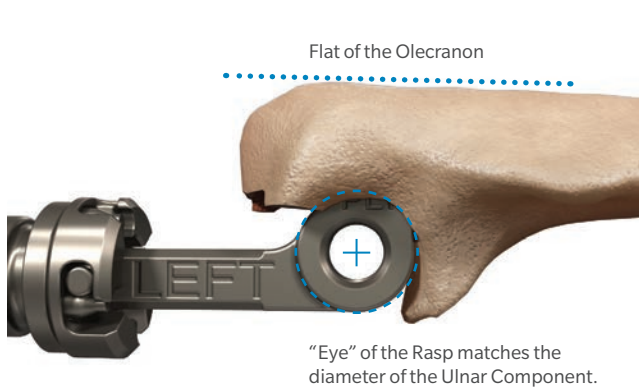

Figure 79

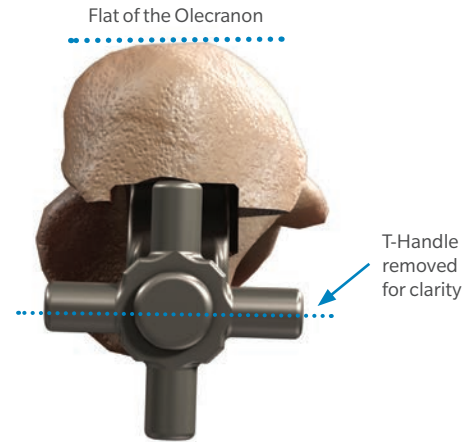

Figure 80

Ulnar Bone Preparation (cont.)

Ulnar Canal Rasping

ⓘ **Note:** Keep the flat posterior surface of the Rasp parallel to the relatively flat surface of the posterior aspect of the olecranon in both the coronal and sagittal planes (Figures 79 & 80).

Continue ulnar canal preparation with the Pilot Ulnar Rasp. Gently impact the T-Handle until the "eye" of the Rasp is concentric with the projected center of the sigmoid notch in the sagittal plane (Figure 79).

Progressively rasp until the desired size or fit is achieved.

Do not remove the final Rasp or T-Handle.

Distal Humeral Reconstruction

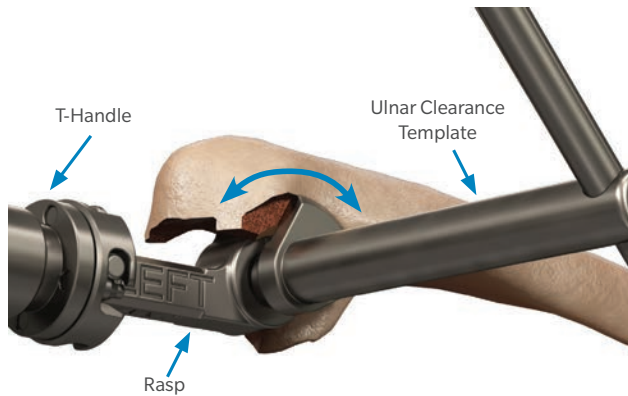

Figure 81

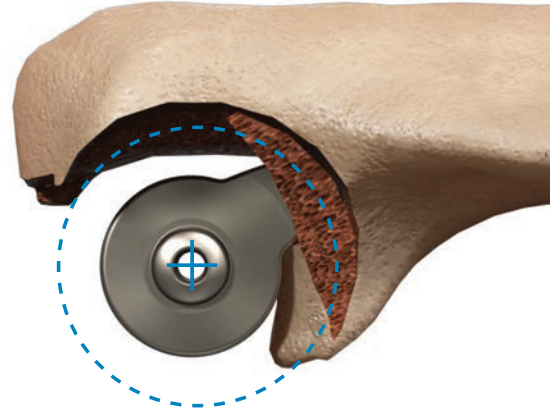

Figure 82

Ulnar Bone Preparation (cont.)

Sigmoid Notch Preparation

Ensure adequate clearance exists around the sigmoid notch to allow articulation. Place the Ulnar Clearance Template through the Ulnar Rasp (Figure 81). Score the bone surface by rotating the Template around the sigmoid notch, while supporting Rasp/T-Handle. Withdraw the Template and remove the remaining bone within the scoring and any other osseous impingements with a bur. Repeat on the opposite side.

Reinsert the Template on each side of the Rasp to confirm adequate bone has been removed and to achieve impingement-free device articulation.

Ulnar Canal Assessment

WARNING: Do not cement the Ulnar Provisional

Assess ulnar canal depth of preparation. Insert the appropriate size/length Ulnar Provisional into the Ulnar canal. If necessary, use a mallet to lightly impact the Ulnar Provisional to final depth. Confirm that the center of the Ulnar Provisional is concentric with the projected center of the greater sigmoid notch (Figure 82).

Distal Humeral Reconstruction

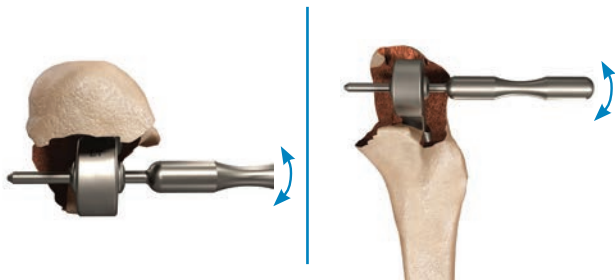

Figure 83



Figure 84

Ulnar Bone Preparation (cont.)

Assess proper rotation of Ulnar Provisional. Use the Humeral Bearing Driver Pin to confirm rotational and varus/valgus alignment (Figure 83).

Distal Humeral Trialing and Implant Assembly/Impaction

Position and snap the appropriately sized distal body and/or intercalary segment trial to the broach/stem trial according to the desired reconstruction length. An audible “click” will be heard when both the tab and flat of both trials are fully aligned (Figure 84).

Trial Reduction

- ⊖ **Note:** The Comprehensive SRS distal bodies and intercalary segment trials can be placed before or after ulna preparation based on surgeon preference.
- ⊖ **Note:** White dimples on the intercalary segment trials represent the locations that porous titanium augments* may be attached. Please see page 4, section “Important Information on Tissue Reattachment Augment* Compatibility and Orientation” for more information.
- ⊖ **Note:** If the definitive stem implant is 8 mm in diameter or smaller, use the small anterior flange (if desired). For implant stem diameters greater than 8 mm and smaller than 13 mm, use the large flange. The same stands true for trials. For example, if a 9 mm broach and trial is in place, a large flange trial should be used. The definitive implant will be a 7 mm stem and the small flange implant will likely fit the best in terms of cortex contact.

*PPS Augments are not indicated for Reverse applications.

Distal Humeral Reconstruction



Figure 85

Trial Reduction (cont.)

Link Provisionals

Insert the appropriate distal humeral provisional and reduce the joint by sliding the Ulnar Provisional into the Humeral Provisional (Figure 85).

Evaluate Range of Motion

Perform a trial range of motion. Remove any osseous impingements. This could include all or portions of the radial head and coronoid process. Perform any additional soft tissue releases as needed.

Remove provisionals by hand or by using the trial separator on the humeral side and the bearing driver pin on the ulnar side.

ⓘ **Note:** Provisionals will provide varus/valgus and internal/ external rotation laxity at the coupling similar to the final Implants.

ⓘ **Note:** Causes for incomplete restoration of elbow extension include: inadequate depth of insertion of the Humeral Component, inadequate depth of insertion of the Ulnar component, unresolved angular deformity, inadequate release of anterior, medial or lateral soft-tissue contracture and posterior bone impingement. Also be Be sure to carefully check the joint for any impingement, specifically anterior between the distal humeral body and the ulnar component and between the distal humeral body and the proximal radius. Assess these factors prior to final component implantation.

Distal Humeral Reconstruction



Figure 86



Figure 87

Implant Assembly and Impaction

Stem Selection

Select the stem implant depending on the desired cement mantle that is 1-3 mm smaller in diameter than the final broach/stem trial.

Flange Assembly (Optional)

Utilizing the 10 lb. torque wrench, secure the appropriate sized flange implant to the selected distal body implant with the locking screw packaged with the flange implant (Figure 86).

ⓘ **Note:** If a modular anterior stability flange is desired, it must be secured to the distal body prior to impacting the distal body to the selected stem

Distal Body to Stem

Utilizing the 2.5 mm 10 lb. torque driver, remove the conical stem screw packaged with the stem and discard.

ⓘ **Note:** When performing a distal humeral replacement leave **EXPOSED** the “L” or “R” for the operative side. This assembly method should leave the slot for the anterior flange or the flange itself aligned with the etched line on the anterior collar of the humeral stem.

Align the distal body with the selected stem and impact the distal body to the stem using the humeral stem inserter and impaction base with 3 or more firm strikes from a heavy mallet (Figure 87).

IMPORTANT: It is critical that both male and female tapers are perfectly clean and dry before impaction. This applies to all taper junctions in the construct.

Distal Humeral Reconstruction

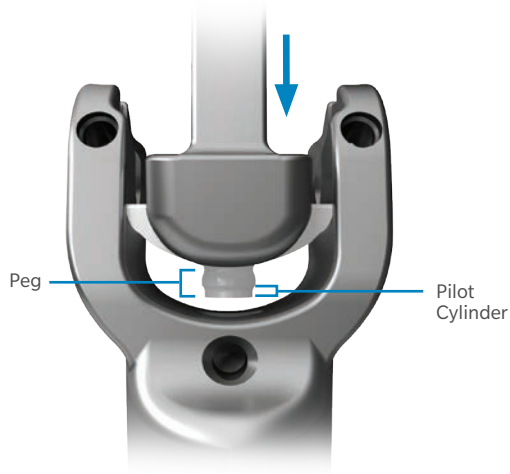

Figure 88

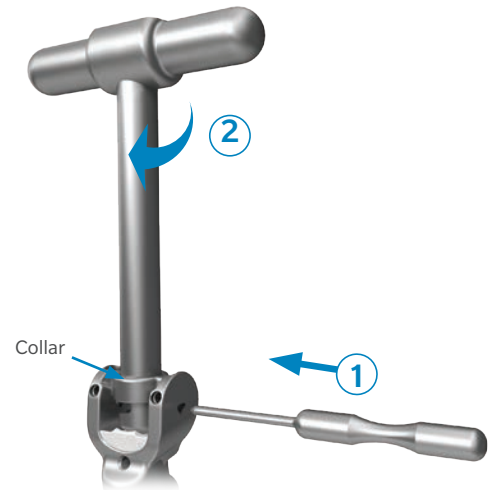

Figure 89

Install the Humeral Bearing

Place the $\frac{5}{8}$ Humeral Bearing into the distal body using the Humeral Bearing Placement Tool (Figure 88). The Humeral Bearing will not be fully seated at this stage. Only the “pilot cylinder” of the peg feature should be inserted into the hole in the base of the yoke of the Humeral Component. See Figure 95 for proper orientation of the Humeral Bearing.

Position the Humeral Bearing Driver against articulation surface of the Humeral Bearing and insert the Humeral Bearing Driver Pin simultaneously through the distal body and the slots in the shaft of the Driver (Figure 89). The handle of Humeral Bearing Driver should be parallel to flat posterior face of the distal body. Turn the T-Handle 90 degrees clockwise. Resistance will be felt, but no audible click will occur.

Distal Humeral Reconstruction



Figure 90

Install the Humeral Bearing (cont.)

The Humeral Bearing will be fully seated when there are no visual gaps when viewing from the posterior and the anterior sides of the Humeral yoke (Figure 90).

ⓘ **Note:** There will be a slight under-hang of the polyethylene in comparison to the distal humeral body.



Figure 91

Implant Assembly and Impaction

Intercalary Segment to Stem

Utilizing the 2.5 mm 10 lb. torque driver, tighten the preassembled conical stem screw into the selected stem or intercalary segment, ensuring that the conical stem screw is properly seated. Impact the stem and intercalary segment using the impaction base and taper impactor with 3 or more firm strikes from a heavy mallet (Figure 91).

ⓘ **Note:** When performing a distal humeral replacement leave EXPOSED the “L” or “R” for the operative side. This assembly method should leave the slot for the anterior flange or the flange itself aligned with the etched line on the anterior collar of the humeral stem.

ⓘ **Note:** It is critical that both male and female tapers are perfectly clean and dry before impaction. This applies to all taper junctions in the construct.

Distal Humeral Reconstruction

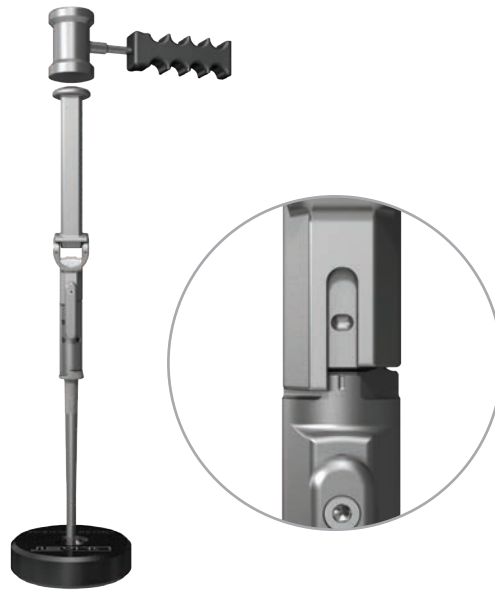

Figure 92

Implant Assembly and Impaction (cont.)

Distal Body to Intercalary Segment

Utilizing the 2.5 mm 10 lb. torque driver, remove the conical stem screw that is assembled in the intercalary segment and discard. Align the distal body to the selected intercalary segment and vigorously impact the distal body to the intercalary segment and stem using the humeral stem inserter and impaction base with 3 or more firm strikes from a heavy mallet (Figure 92).

Advance the 2.5 mm posterior access locking screw into the intercalary segment until firmly seated against the internal conical locking screw at the stem/intercalary segment taper junction using the 10 lb. torque driver.

- ⓘ **Note:** It is critical that both male and female tapers are perfectly clean and dry before impaction. This applies to all taper junctions in the construct.
- ⓘ **Note:** This assembly method should leave the slot for the anterior flange aligned with the etched line on the anterior collar of the humeral stem.
- ⓘ **Note:** When using a 30 mm Anti-Rotation segment, during assembly simply keep the anterior slot on the distal body in line with the anterior slot on the 30 mm anti-rotation segment which should be in line with the etched line on the anterior collar of the humeral stem (slot-slot-line) as shown in 92 Inset. This also means that the tab on the 30mm anti-rotation segment will always cover the “R” on the collar of the humeral stem.

Distal Humeral Reconstruction



Figure 93

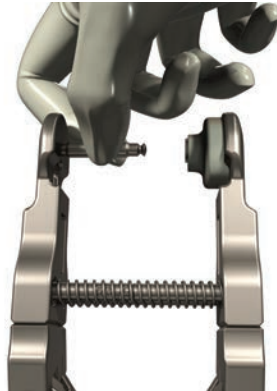

Figure 94

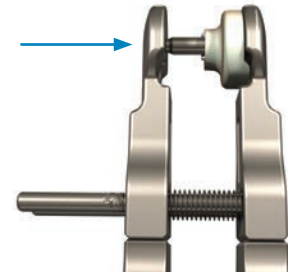
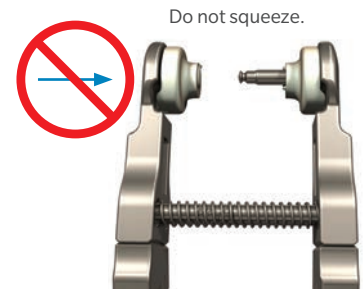

Figure 95



Do not squeeze.

Figure 96

Install the Ulnar Bearing

Load an Ulnar Bearing into one side of the Ulnar Bearing Assembly Tool (UBAT) (Figure 93).

Load the Axle-Pin into the opposite jaw of the tool maintaining a finger-hold on the Axle-Pin (Figure 94).

Squeeze the handles. Stop when hard resistance is felt – no audible click will be heard (Figure 95).

Load the second Ulnar Bearing. DO NOT squeeze the second Bearing onto the Axle-Pin (Figure 96).

ⓘ **Note:** Articulation Kits come in two sizes (4 and 5/6). The 5/6 will always be used with the distal body.

Distal Humeral Reconstruction

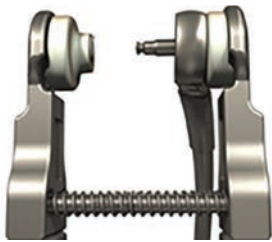

Figure 97

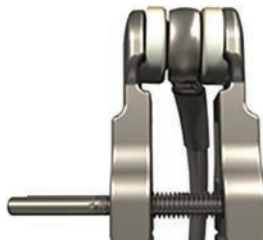

Figure 98



Figure 99

Install the Ulnar Bearing (cont.)

Attach the Bearing/Axle-Pin assembly to the Ulnar Component.

- Carefully place the Axle-Pin through the eye of the Ulnar Component (Figure 97)

Squeeze the handles of the pre-loaded Ulnar Bearing Assembly Tool (UBAT) until hard resistance is felt.

- No audible click will be heard (Figure 98)

ⓘ **Note:** Bearings/Axle-Pin assembly is designed to be loose fitting to the Ulnar eye.

ⓘ **Note:** Use caution to avoid contact between the Axle-Pin and the Ulnar Component to avoid scratching the Implant.

Place two Diverters directly on the neck of the Ulnar Component. Do not slide the diverters up to the neck from the distal end of the implant (Figure 99).

- Diverters must be installed 180 degrees out of phase.
- Diverter slits must be perpendicular to the ulnar eye axis.

Distal Humeral Reconstruction



Figure 100

Component Implantation

Prepare Canals for Cementing

Prepare the humeral and ulnar canals for cementing. Use copious irrigation to clean both medullary canals, then dry. Insert Cement Restrictors as needed.

Tip: The use of high viscosity cement is difficult in smaller diameter cement nozzles used in elbow replacement. Be sure to inject the cement when still in the viscous state.

Cement Ulnar Component

Inject cement into the ulnar canal. Cut the Cement Nozzle to the length of the Ulnar Component. Leave approximately 1 cm of the proximal canal free of cement to avoid excessive backflow (Figure 100).

Distal Humeral Reconstruction

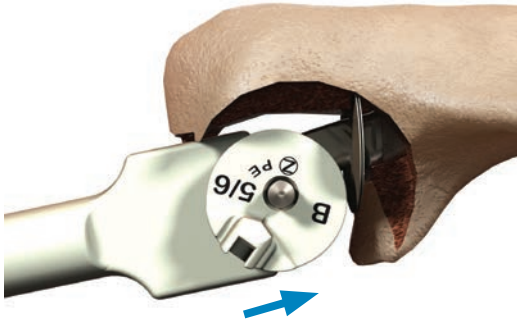

Figure 101

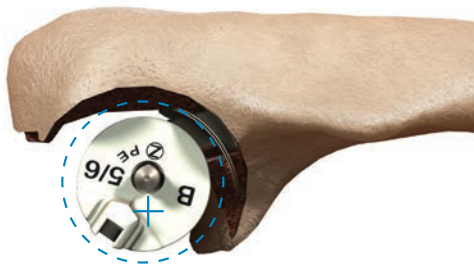

Figure 102

Component Implantation (cont.)

Insert the Ulnar Component into the canal.

Fully seat and align the Ulnar Component (Figure 101). Use the Ulnar Stem Inserter to protect the articular surface of the Ulnar Component from damage during insertion. Ensure the implant is perpendicular with the flat plane of the olecranon. Center the Ulnar eye on the projected center of the greater sigmoid notch (Figure 102).

Remove excess cement from around the Ulnar Component. Use the plastic Quik-Use® Curette to avoid scratching the Implant.

Remove the cement diverters after final positioning of the implant, but before the cement has fully hardened.

Note: Excess/loose cement can lead to third-body wear of the articulation.

Note: Only use the Ulnar Stem Inserter to seat the Ulnar Implant.

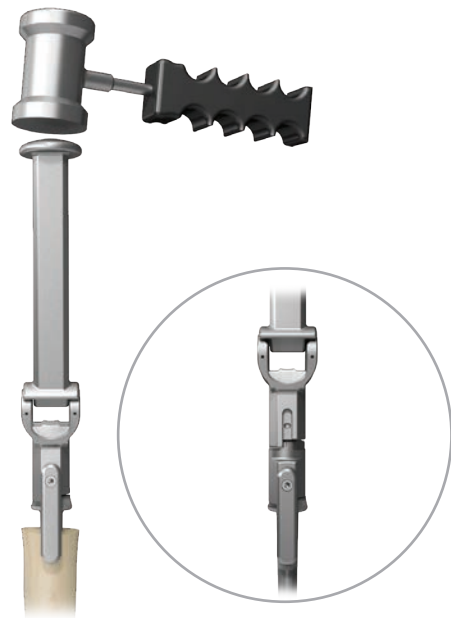

Figure 103

Distal Humeral Implant Insertion

Humeral Stem Insertion

Remove the humeral trial components. Assemble the distal construct onto the distal body impactor. Use a pulse/lavage suction unit to thoroughly clean the humeral canal. A cement plug may be used to prevent cement escape. Dry the canal with absorbent gauze and inject doughy cement in a retrograde manner. Introduce the implant construct into the humeral canal (Figure 103) until the stem ledge makes full contact with the bone at the resection level. Remove excess cement.

Distal Humeral Reconstruction



Figure 104

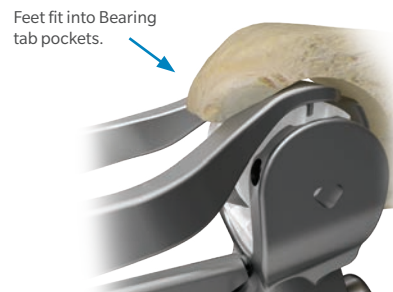

Figure 105



Figure 106

Final Assembly

Elbow Reduction

Begin to reduce the joint. Align the Axle-Pin and the tabs of the Ulnar Bearings to the slots of the distal body (Figure 104). Partially reduce the joint by applying hand pressure to the forearm to drive the Axle-Pin and Bearings into the distal body.

Finish reduction of joint. To complete reduction of the joint, apply the Articulation Inserter. Top of the Articulation Inserter fits into the Ulnar Bearing tab pockets. Bottom of the Articulation Inserter fits into the proximal posterior hole in the distal body (Figures 105 and 106).

Squeeze the instrument until resistance is felt and Bearings are fully seated. No audible click will be heard. The Ulnar Bearings should appear flush with the curved distal surfaces of the distal body.

TIP: The Ulnar Bearing Tamp is an alternate tool available to assist with alignment and insertion of the articulation, if access is unachievable with the Articulation Inserter.

Distal Humeral Reconstruction



Figure 107



Figure 108

Tighten until "Click" is heard.



Figure 109

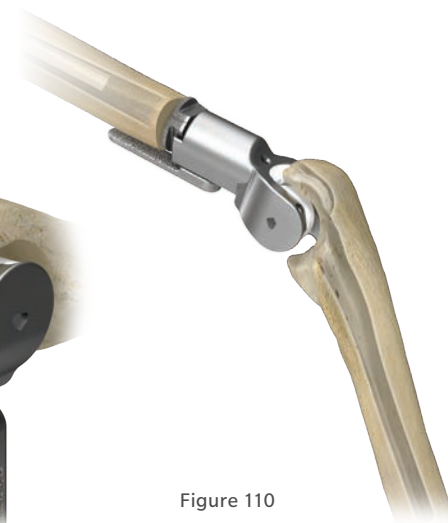

Figure 110

Humeral Screw Insertion

- ⓘ **Note:** Proper application of torque to install the Humeral Screws is required for a successful prosthesis; only use the tools provided in the instrument set to apply torque.
- ⓘ **Note:** If Bearings are not flush with the distal body, difficulty might be encountered during Humeral Screw insertion. Ensure Bearings are fully seated prior to inserting Screws. (Figure 107)
- ⓘ **Note:** Never reuse any Humeral Screw after it has been installed to its prescribed torque, even if during same surgery. The Elbow Torque Driver is designed for single-surgery.
- ⓘ **Note: The Elbow Torque Driver is Single Use and Disposable. A sterile driver must be opened new for each surgery.**

Humeral Screw Loading

- Use the flexible plastic tubing to grasp the Humeral Screw.
- Thread Humeral Screw into the black-etched side of a Screw Holder.
- Remove and discard the tubing.
- Repeat with second Screw and second Screw Holder.

Insert the screws. Place the loaded Humeral Screw Holder against the posterior face of the distal body and drive the Screw free of the Screw Holder; repeat on the other side.

Sequentially tighten the Screws to the prescribed torque. Lightly snug each Screw before final torquing either one. Drive each Screw to the final torque with the Elbow Torque Driver until an audible "click" is heard (Figures 108 and 109). Dispose of Elbow Torque Driver when finished.

Final Range of Motion

Perform a final range of motion. Remove any impinging bone and address any soft tissue contractures. (Figure 110)

- ⓘ **Note:** Be sure to carefully check the joint for any impingement, specifically anterior between the distal humeral body and the ulnar component and between the distal humeral body and the proximal radius.
- ⓘ **Note:** For the bearing revision technique, reference the Nexel Total Elbow System Surgical Technique.

Total Humeral Reconstruction



Figure 111



Figure 112

Pre-Operative Planning

Preoperatively determine the length of the humerus and select the probable components using the template, if available. After removal of the humerus, use the proximal body, intercalary segments, the total humeral coupler and the distal body trials to reconstruct the humerus (Figure 111).

Tip: Final implant selection frequently cannot be made until the actual time of surgery, however, with appropriate planning a consistent operative plan with alternatives can be formulated.

Implant Construction Length

The overall replacement length is measured from the center of the anatomic neck of the proximal humerus to the axis of rotation of the elbow joint. Total implant reconstruction length can be computed by adding the designated lengths for the proximal body, distal body and intercalary segment lengths plus 100 mm for the humeral coupler.

Patient Positioning and Surgical Incision

Patient Positioning

Place the patient in a supine position. Position the affected arm using the appropriate rotation that will allow the best access to the total humerus including the shoulder and elbow joint. (Figure 112).

Surgical Incision

Make a longitudinal incision slightly lateral to the medial epicondyle and just medial to the tip of the olecranon.

Identify the ulnar nerve and decompress the cubital tunnel. Mobilize and carefully control the nerve along the medial/anterior border of the skin incision.

Excise the intermuscular septum to ensure proper transposition of the nerve. Pay careful attention to the location of the ulnar nerve throughout the entire procedure. Eventual handling of the nerve should be individualized. The developing surgeons advocate anterior transposition.

Humeral and Ulnar Preparation

Utilize the same surgical steps found earlier in the technique for glenoid and ulna preparation.

Total Humeral Reconstruction



Figure 113



Figure 114

Total Humeral Component Assembly and Impaction

Distal Body to Coupler

Utilizing the 2.5 mm 10 lb. torque driver, remove the distal conical stem screw that is packaged with the total humeral coupler and discard. Align the distal body to the selected intercalary segment or total humeral coupler and vigorously impact the distal body to the intercalary segment or total humeral coupler using the distal body impactor and taper impactor with three or more firm strikes from a heavy mallet (Figure 113).

ⓘ **Note:** Anytime an SRS/Nexel Distal Body is used, there is no axial screw. The screw in the distal total humeral segment or standard segment is removed and discarded and the only form of fixation is the Morse Taper connection.

Intercalary Segment to Coupler

Utilizing the 2.5 mm 10 lb. torque driver, tighten the preassembled conical screw into the selected intercalary segment and humeral coupler, ensuring that the conical stem screw is properly seated. Impact the total humeral coupler and intercalary segment using the impaction base and taper impactor with three or more firm strikes from a heavy mallet (Figure 114).

ⓘ **Note:** It is critical that both male and female tapers are perfectly clean and dry before impaction. This applies to all taper junctions in the construct.

Total Humeral Reconstruction



Figure 115



Figure 116

Total Humeral Component Assembly and Impaction (cont.)

Proximal Body to Coupler

There are specific proximal body impactors for each of the 3 proximal body designs. Snap the appropriate (Small Revision, Large Revision or Tumor Style) proximal body impactor onto the impactor handle. Place the impactor/impactor handle over the proximal aspect of the proximal body and impact the proximal body to the total coupler or intercalary segment using the proximal body impactor base and distal body impactor with three or more firm strikes from a heavy mallet (Figure 115).

Advance the side access locking screws onto the internal conical screw at every taper junction except the distal taper junction.

Total Humeral Component Insertion

Clean and dry the reverse morse taper in the proximal body. Gently place the super EAS head on the tumor style proximal body. Rotate the super EAS head until the opening is directly medial (Figure 116).



Utilizing the Versa-Dial head impactor, impact the head onto the tumor style proximal body to complete the humeral head implantation by using two firm strikes with an appropriately sized surgical mallet and the head impactor tool.

Ulnar Component Final Implant



To reconstruct the ulna and assemble the condyles, please refer to Ulnar Component Insertion within this technique.

Implants



Proximal Body

Product	Description	Size	Part Number
	Comprehensive Segmental Revision System Proximal Body – Small	48 mm	211215
		58 mm	211216
		68 mm	211217
	Comprehensive Segmental Revision System Proximal Body - Large	42 mm	211218
		52 mm	211219
		62 mm	211220
	Comprehensive Segmental Revision Tumor Body	51 mm	211221
		61 mm	211222
		71 mm	211223

Intercalary Segments

Product	Description	Size	Part Number
	Comprehensive Segmental Revision System Intercalary Segments w/ screw	30 mm	211224
		60 mm	211225
		90 mm	211226
		120 mm	211227
	Comprehensive Segmental Revision System Humeral Coupler w/ screw	–	211257
	Comprehensive Segmental Revision System Anti-Rotation Intercalary Segment w/ screw	30 mm	211266

Soft Tissue Augments*

Product	Description	Size	Part Number
	Comprehensive Segmental Revision System Modular Augment w/ screw	SM	211228
		LG	211229
	Comprehensive Segmental Revision System Modular PPS Augment w/ screw	SM	211267
		LG	211268

*PPS Augments are not indicated for Reverse applications.

Implants (cont.)



Intramedullary Stems

Product	Description	Size	Part Number
	Comprehensive Segmental Revision System Modular Stem w/ screw	6 x 75 mm	211230*
		8 x 75 mm	211231*
		9 x 75 mm	211258
		10 x 75 mm	211232
		11 x 75 mm	211262
		12 x 75 mm	211233
		14 x 75 mm	211234
		16 x 75 mm	211274
		18 x 75 mm	211280
		6 x 100 mm	211235*
		8 x 100 mm	211236
		9 x 100 mm	211259
		10 x 100 mm	211237
		11 x 100 mm	211263
		12 x 100 mm	211238
		14 x 100 mm	211239
		16 x 100 mm	211275
		18 x 100 mm	211282
		4 x 150 mm	211240*
		6 x 150 mm	211241*
		8 x 150 mm	211242
		9 x 150 mm	211260
		10 x 150 mm	211243
		11 x 150 mm	211264
		12 x 150 mm	211244
		14 x 150 mm	211276
		16 x 150 mm	211283
		6 x 200 mm	211246
		8 x 200 mm	211247
		9 x 200 mm	211261
10 x 200 mm	211248		
11 x 200 mm	211265		
12 x 200 mm	211249		
14 x 200 mm	211284		

* Denotes stems manufactured from Co-Cr-Mo. All other stems are manufactured from Ti-6Al-4V.

Implants (cont.)

Distal Body

Product	Description	Size	Part Number
	Comprehensive Segmental Revision System Distal Humeral Body w/ screw	50 mm LT	110029824
		60 mm LT	110029825
		70 mm LT	110029826
		50 mm RT	110029938
		60 mm RT	110029939
		70 mm RT	110029940
	Comprehensive Segmental Revision System Flange w/ screw	-	211269
			211270



Super EAS Head Implants

Product	Description	Size	Part Number
	Comprehensive Segmental Revision System Super EAS Head	40 X 15 mm	211256
		44 X 17 mm	211277
		48 X 19 mm	211278
		54 X 22 mm	211279

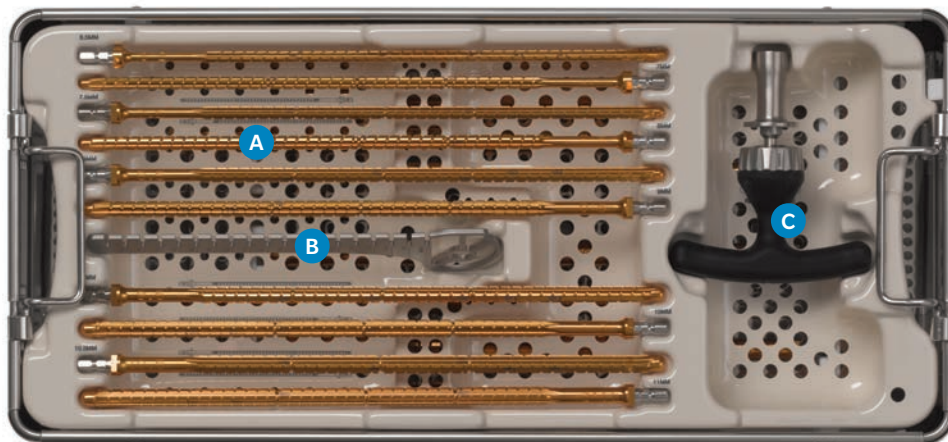
Tray 1



595293 Top

Product	Description	Label	Size	Part Number
	Cylindrical Reamer	A	6.5 mm	475801
			7.0 mm	475802
			7.5 mm	475803
			8.0 mm	475804
			8.5 mm	475805
			9.0 mm	475806
			9.5 mm	475807
			10.0 mm	475808
			10.5 mm	475809
			11.0 mm	475810
				Bone Resection Template
	Ratcheting T-handle	C	–	406801

Tray 1

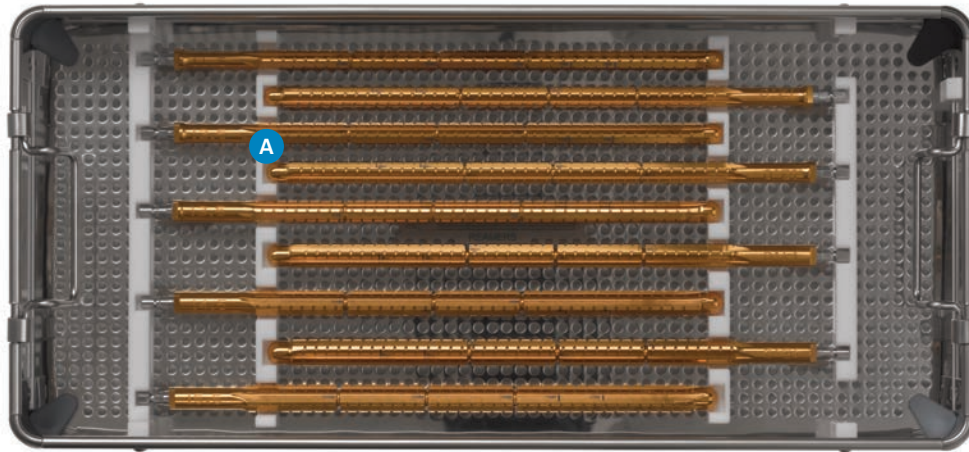



595293 Bottom

Product	Description	Label	Size	Part Number
	Cylindrical Reamer	A	11.5 mm	475811
			12.0 mm	475812
			12.5 mm	475813
			13.0 mm	475814
			13.5 mm	475815
			14.0 mm	475816
			14.5 mm	475817
			15.0 mm	475818
			15.5 mm	475819

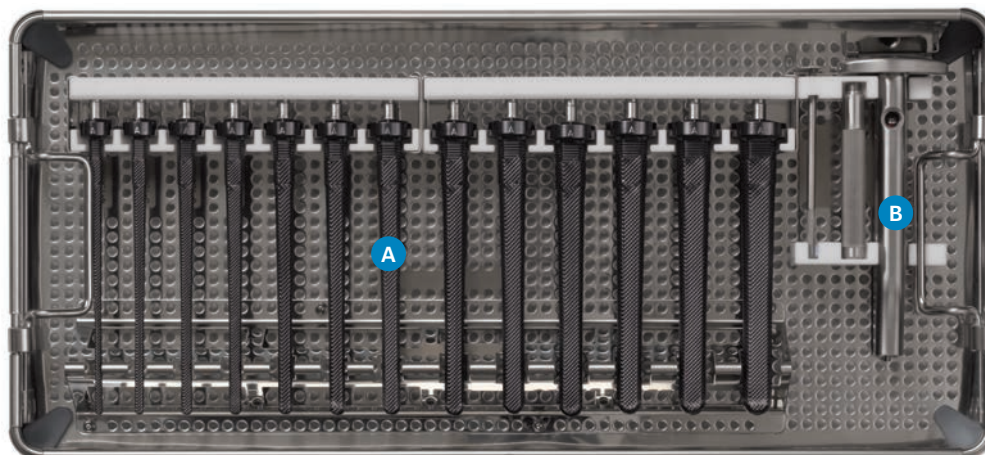
Tray 2



595294

Product	Description	Label	Size	Part Number
	Comprehensive Humeral Broach/Stem Trial	A	4 x 150 mm	405126
			5 x 150 mm	405209
			6 x 150 mm	405127
			7 x 150 mm	405210
			8 x 150 mm	405128
			9 x 150 mm	405171
			10 x 150 mm	405129
			11 x 150 mm	405175
			12 x 150 mm	405130
			13 x 150 mm	405211
			14 x 150 mm	405212
			15 x 150 mm	405213
			16 x 150 mm	405214
				Comprehensive Segmental Revision System Broach Handle w/ Alignment Rod

Tray 3

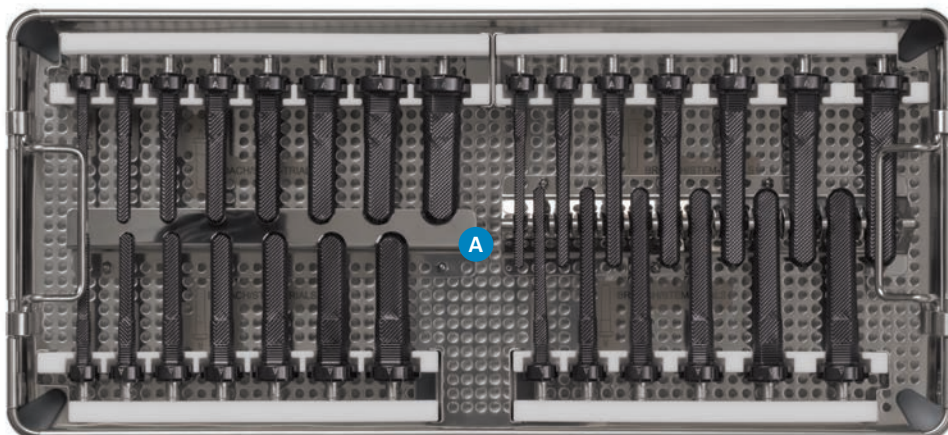





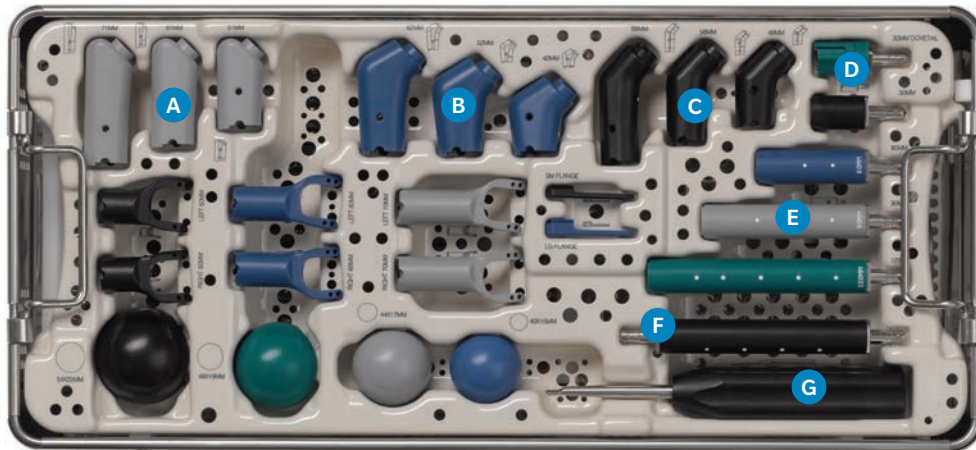

595295

Product	Description	Label	Size	Part Number
	Comprehensive Humeral Broach/Stem Trial	A	6 x 75 mm	405116
			7 x 75 mm	405195
			8 x 75 mm	405117
			9 x 75 mm	405169
			10 x 75 mm	405118
			11 x 75 mm	405173
			12 x 75 mm	405119
			13 x 75 mm	405196
			14 x 75 mm	405120
			15 x 75 mm	405197
			16 x 75 mm	405198
			17 x 75 mm	405199
			18 x 75 mm	405200
			19 x 75 mm	405201
			20 x 75 mm	405202
			6 x 100 mm	405121
			7 x 100 mm	405203
			8 x 100 mm	405122
			9 x 100 mm	405170
			10 x 100 mm	405123
11 x 100 mm	405174			
12 x 100 mm	405124			
13 x 100 mm	405204			
14 x 100 mm	405125			
15 x 100 mm	405205			
16 x 100 mm	405206			
17 x 100 mm	405207			
18 x 100 mm	405208			

Tray 4







595296 – Top

Product	Description	Label	Size	Part Number
	Comprehensive Proximal Tumor Body Trial	A	51 mm 61 mm 71 mm	405107 405108 405109
	Comprehensive Revision Proximal Body Trial - Large	B	42 mm 52 mm 62 mm	405104 405105 405106
	Comprehensive Revision Proximal Body Trial - Small	C	48 mm 58 mm 68 mm	405101 405102 405103
	Comprehensive Anti-Rotation Intercalary Segment Trial	D	30 cm	405177
	Comprehensive Intercalary Segment Trial	E	30 cm 60 cm 90 cm 120 cm	405110 405111 405112 405113
	Comprehensive Segmental Revision Total Humeral Coupler Trial	F	–	405143
	Comprehensive Segmental Revision Trial Separator	G	–	405229

Tray 4 (cont.)



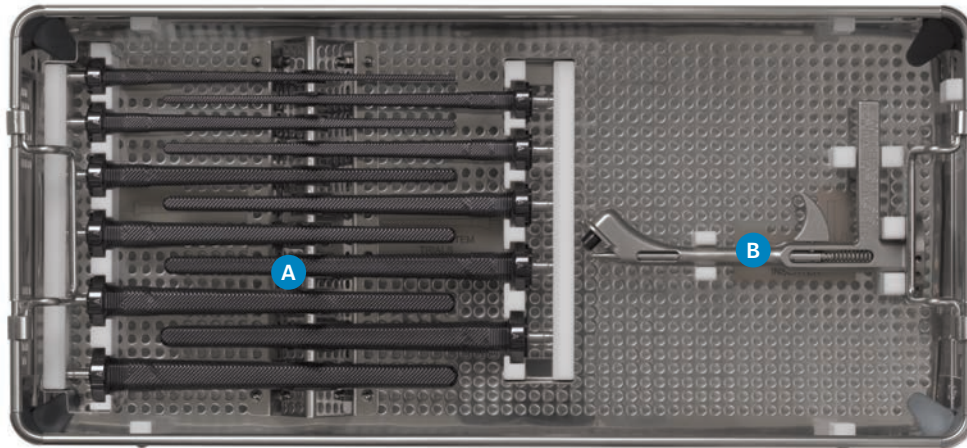

595296 – Top

Product	Description	Label	Size	Part Number
	Comprehensive HRS Anti-Rotation Flange Trial	H	SMALL LARGE	405180 405181
	Comprehensive Segmental Revision I System EAS Humeral Head Trial		40 x 15 mm 44 x 17 mm 48 x 19 mm 54 x 22 mm	405142 405192 405193 405194
	Comprehensive Segmental Revision System Distal Humeral Body Trial - LT	J	50 mm 60 mm 70 mm	110029259 110029260 110029261
	Comprehensive Segmental Revision System Distal Humeral Body Trial - RT	J	50 mm 60 mm 70 mm	110029941 110029942 110029943

Tray 4 (cont.)



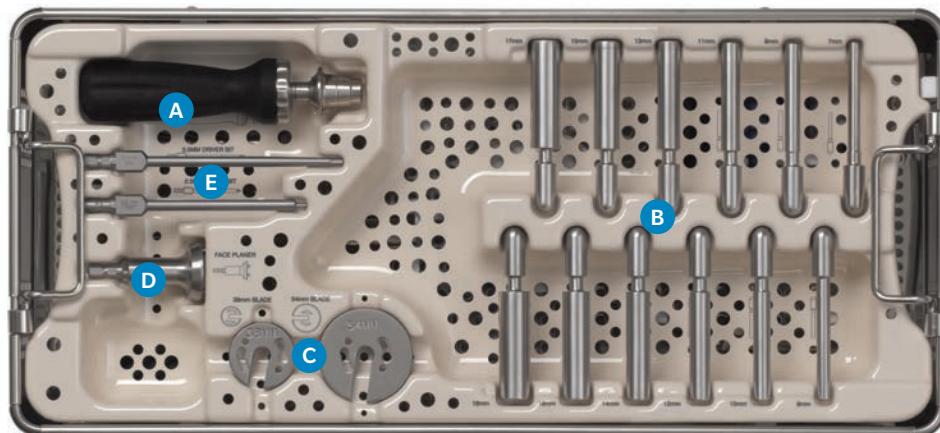

595296 – Bottom

Product	Description	Label	Size	Part Number
	Comprehensive Humeral Broach/Stem Trial	A	4 x 150 mm	405126
			5 x 150 mm	405209
			6 x 150 mm	405127
			7 x 150 mm	405210
			8 x 150 mm	405128
			9 x 150 mm	405171
			10 x 150 mm	405129
			11 x 150 mm	405175
			12 x 150 mm	405130
			13 x 150 mm	405211
			14 x 150 mm	405212
			15 x 150 mm	405213
			16 x 150 mm	405214
	Comprehensive Segmental Revision System Proximal Body Impactor/Insertor	B	–	405167

Tray 5







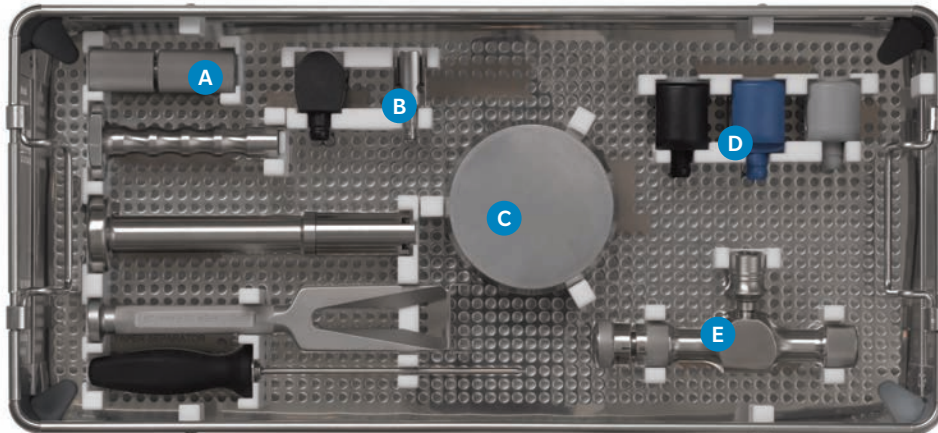

595297 – Top

Product	Description	Label	Size	Part Number
	Comprehensive Reverse Ratcheting Handle	A	–	405908
	Comprehensive Face Planer Pilot	B	7 mm 8 mm 9 mm 10 mm 11 mm 12 mm 13 mm 14 mm 15 mm 16 mm 17 mm 18 mm	405182 405183 405184 405185 405186 405187 405188 405189 405190 405224 405225 405226
	Comprehensive Segmental Revision Face Planer Blade	C	38 mm 54 mm	405222 405223
	Face Planer	D	–	405166
	3.5 mm Hex Driver	E	3.5 mm	405234

Tray 5 (cont.)



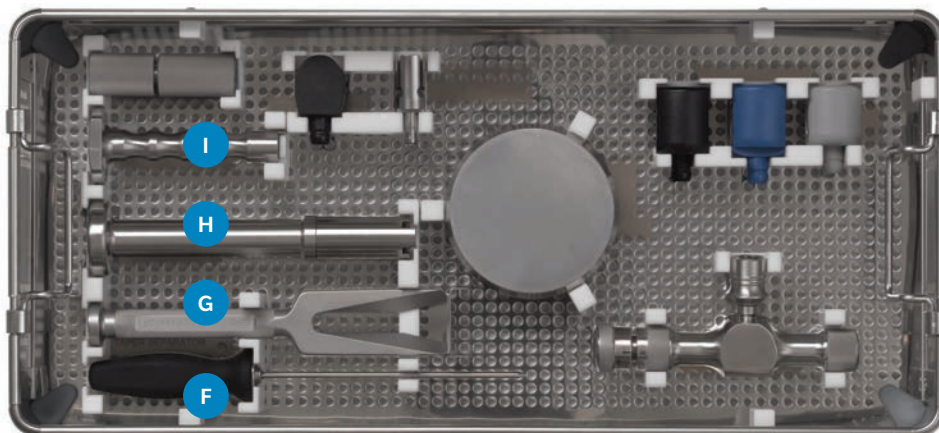

595297 – Bottom

Product	Description	Label	Size	Part Number
	Comprehensive Segmental Revision Stem Extractor	A	–	405220
	Comprehensive Segmental Revision Stem To Trial Adapter	B	–	405227
	Comprehensive Segmental Revision System Impactor Base	C	–	405219
	Revision Proximal Body Impactor	D	SMALL	405230
	Revision Proximal Body Impactor	D	LARGE	405231
	Revision Proximal Body Impactor	D	TUMOR	405232
	Variable Torque Limiting T-handle	E	–	31-301850

Tray 5 (cont.)



595297 – Bottom (cont.)

Product	Description	Label	Size	Part Number
	Comprehensive Segmental Revision Torque Driver	F	10 IN*LBF	405228
	Taper Separator	G	-	405168
	Mosaic™ Taper Impactor	H	-	405052
	Impactor Handle	I	-	414925

For indications, contraindications, warnings, precautions, potential adverse effects and patient counseling information, see the package insert or contact your local representative; visit www.zimmerbiomet.com for additional product information.

INDICATIONS

1. Non-inflammatory degenerative joint disease including osteoarthritis and avascular necrosis.
2. Rheumatoid arthritis.
3. Revision where other devices or treatments have failed.
4. Correction of functional deformity.
5. Oncology applications including bone loss due to tumor resection.

When used in a proximal or total humeral replacement, the Comprehensive Segmental Revision System (SRS) is also intended for the treatment of acute or chronic fractures with humeral head (shoulder) involvement, which are unmanageable using other treatment methods.

When used as a distal or total humeral replacement, the Comprehensive Segmental Revision System (SRS) is also intended for treatment of acute or chronic fractures with humeral epicondyle (elbow) involvement, which are unmanageable using other treatment methods.

The Comprehensive SRS is intended for use with or without bone cement in the proximal shoulder.

The Comprehensive SRS is intended for use with bone cement in distal humeral and total humeral applications.

Tissue attachment augments provide the option for tissue stabilization and attachment.

Biomet Comprehensive Segmental Revision System is indicated for use in a reverse application in patients whose shoulder joint has a grossly deficient rotator cuff with severe arthropathy and/or previously failed shoulder joint replacement with a grossly deficient rotator cuff. The patient must be anatomically and

structurally suited to receive the implants and a functional deltoid muscle is necessary. Reverse application is limited to proximal humeral replacement in the United States and Canada.

Reverse application is limited to proximal humeral replacement in the United States and Canada.

The Biomet Comprehensive Segmental Revision System Modular Porous Plasma Spray (PPS) Augments are not indicated for Reverse applications.

CONTRAINDICATIONS

Absolute contraindications include: infection, sepsis, and osteomyelitis.

Relative contraindications include: 1) Uncooperative patient or patient with neurologic disorders who is incapable of following directions, 2) Osteoporosis, 3) Metabolic disorders which may impair bone formation, 4) Osteomalacia, 5) Distant foci of infections which may spread to the implant site, 6) Vascular insufficiency, muscular atrophy, or neuromuscular disease.

For complete product information, including warnings and precautions, see 'Patient Risk Information' at www.biomet.com and the package insert.

The Comprehensive Segmental revision System is contraindicated for use in a reverse shoulder application in patients receiving radiation therapy as this may impact soft tissue stability.

This material is intended for healthcare professionals and the Zimmer Biomet sales force. Distribution to any other recipient is prohibited.

For indications, contraindications, warnings, precautions, potential adverse effects and patient counselling information, see the package insert or contact your local representative; visit www.zimmerbiomet.com for additional product information.

Zimmer Biomet does not practice medicine. This technique was developed in conjunction with health care professionals. This document is intended for surgeons and is not intended for laypersons. Each surgeon should exercise his or her own independent judgment in the diagnosis and treatment of an individual patient, and this information does not purport to replace the comprehensive training surgeons have received. As with all surgical procedures, the technique used in each case will depend on the surgeon's medical judgment as the best treatment for each patient. Results will vary based on health, weight, activity and other variables. Not all patients are candidates for this product and/or procedure. Caution: Federal (USA) law restricts this device to sale by or on the order of a surgeon. Rx only.

All content herein is protected by copyright, trademarks and other intellectual property rights, as applicable, owned by or licensed to Zimmer Biomet or its affiliates unless otherwise indicated, and must not be redistributed, duplicated or disclosed, in whole or in part, without the express written consent of Zimmer Biomet. This material is intended for health care professionals. Distribution to any other recipient is prohibited.

©2021, 2022 Zimmer Biomet.



0097.3-US-en-Issue Date 2022-02-16



Legal Manufacturer
Biomet Orthopedics
P.O. Box 587
56 E. Bell Drive
Warsaw, Indiana 46581-0587
USA

www.zimmerbiomet.com



CE mark on a surgical technique is not valid unless there is a CE mark on the product label.