



Zimmer®
Gender Solutions™
Patello-Femoral
Joint (PFJ) System

Surgical Technique



Advancing the science of partial knee replacement.



Description

The *Zimmer® Gender Solutions™* Patello-Femoral Joint Prosthesis (PFJ) is intended for replacement of the femoral trochlea of the patellofemoral joint that has been affected by the disease process and/or injury. The PFJ prosthesis may be used alone or with the *Zimmer* Unicompartamental Knee System or *M/G®* Unicompartamental Knee System to treat conditions of the patellofemoral or tibiofemoral regions of the knee. The PFJ prosthesis is compatible with either an unresurfaced patella, a *NexGen®* all-polyethylene, porous or augmentation patella or a *Gender Solutions Natural-Knee®* Flex all-polyethylene or metal-backed patella. PFJ prostheses are manufactured from Cobalt-Chromium-Molybdenum alloy and utilize Poly Methyl Methacrylate (PMMA) precoat.

Indications

- Osteoarthritis, traumatic arthritis, polyarthritis, and/or severe chondrocalcinosis of the patellofemoral joint
- The salvage of previously failed surgical attempts (e.g., arthroscopy, lateral release, cartilage transplantation)
- History of patellar dislocation or patella fracture
- Dysplasia-induced patellofemoral degeneration

This device is intended for cemented use only.

Contraindications

- Previous history of infection in the affected joint and/or local/systemic infection that may affect the prosthetic joint
- Insufficient bone stock
- Insufficient menisci and/or ligament structures
- Skeletal immaturity
- Neuropathic arthropathy
- Severe instability, maltracking, malalignment of the patella, patellofemoral and/or tibiofemoral joints
- Patellofemoral arthroplasty is contraindicated in patients who have rheumatoid arthritis (RA) and an ulcer of the skin or a history of recurrent breakdown of the skin because their risk of postoperative infection is greater. RA patients using steroids may also have increased risk of infection. Late infections in RA patients have been reported 24+ months postoperative.

Zimmer® Gender Solutions™ Patello-Femoral Joint (PFJ) System Surgical Technique

Table of Contents

SECTION	PAGE
1 Exposure	
Exposure	1
2 Resect Patella	
Resecting the Patella	2
3 Mark Femoral Landmarks	
Marking Femoral Anatomic Landmarks	3
4 Perform Femoral Anterior Cut	
4.1 Drilling the IM Hole	4
4.2 Assembling the Telescoping Boom to the IM Anterior Cut Guide	4
4.3 Inserting the IM Anterior Cut Guide with Telescoping Boom	6
4.4 Setting External Rotation and Depth for Anterior Cut	7
4.5 Securing the Guide and Making the Anterior Cut	9
5 Size Femoral Trochlea	
5.1 Milling Guide Set-up and Positioning	11
5.2 Trochlear Component Size Determination	14
6 Mill Femoral Trochlea	
6.1 Securing the Milling Guide	16
6.2 Performing the Milling Operation	17
7 Drill Peg and Tail Holes	
Drilling Peg and Tail Holes	22
8 Perform Trial Reduction	
Performing Trial Reduction	25

SECTION	PAGE
9	Implant Trochlea and Patella Prostheses
9.1	Cementing/Implanting the PFJ Implant 28
9.2	Cementing/Implanting the Patella and Checking Motion 29
10	Bicompartmental Arthroplasty: Using the Zimmer Gender Solutions PFJ with a Zimmer Unicompartamental Implant
10.1	Compatibility. 30
10.2	Sequence - Implanting the Gender Solutions Patello-Femoral Joint First 30
10.3	Unicondylar Technique 30
11	Closure
	Closure. 31

Exposure

The *Gender Solutions* PFJ instrumentation is compatible with MIS arthrotomies. Various exposures can be considered including medial parapatellar, lateral parapatellar, midvastus, subvastus, etc. Resection of the infrapatellar fat pad can facilitate exposure. During arthrotomy it is important to avoid inadvertently cutting the anterior horns of the menisci or intermeniscal ligament.

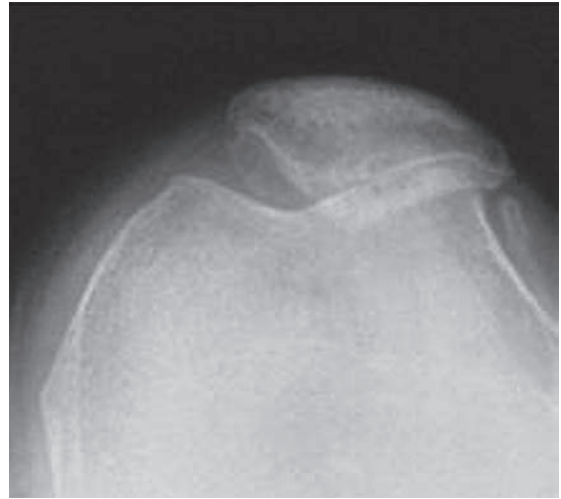

Resect Patella

- After selecting the appropriate Zimmer patellar system, one of the following options may be used to prepare the patella.
 - MIS Patella Resection Guide
 - Standard Patella Instruments
 - Patella Reamer System
- Select the appropriate size patella which provides for the best support of the patella on the condyles after it transitions off of the trochlear component.

Mark Femoral Landmarks

- Mark the A/P axis (Whiteside's line) from the lowest part of the trochlea to the highest part of the intercondylar notch (Fig1).
- With a skin marker, mark a line perpendicular to the A/P axis (Fig2).

TECHNIQUE TIP

3.A

Technique Tip: Alternatively, the transepicondylar axis may be used as reference.

N **NOTE:** These marks will serve as references in setting external rotation in subsequent steps.

Fig. 1

Mark the A/P axis.

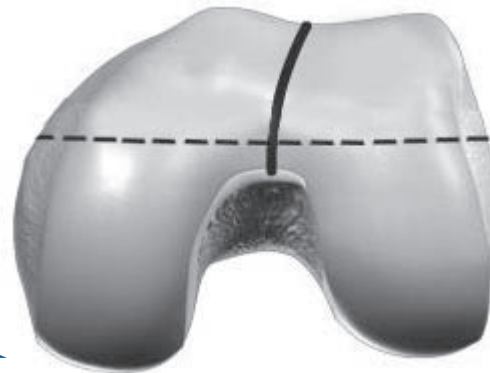
Fig. 2

Mark a line perpendicular to the A/P axis.

Femoral Anterior Cut

4.1 Drilling the IM Hole

- Use the 6mm Intramedullary (IM) drill to drill the hole (Fig. 3).

N NOTE: Hole location is 10 mm anterior to the origin of the posterior cruciate ligament.



Fig.3

Drilling IM hole.

4.2 Assembling the Telescoping Boom to the IM Anterior Cut Guide

- Unlock the Telescoping Boom by loosening the knurled knob. (Fig. 4).

N NOTE: The locking boom (00-5983-028-00) is compatible with the IM Anterior Cut Guide and is available separately.

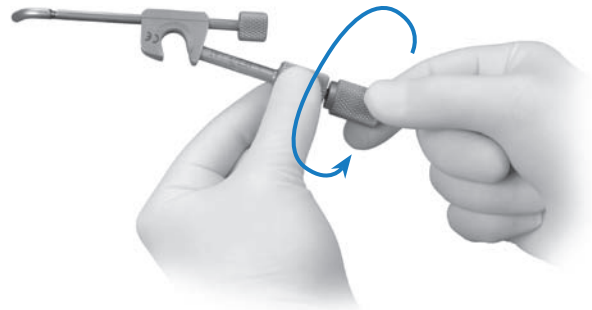

Fig.4

Unlock Telescoping Boom.

- Push down and hold adjustment knob on the IM Anterior Cut Guide (**Fig.5**) while sliding the Telescoping Boom onto the IM guide collar (**Fig.6**). Boom may be inserted from either medial or lateral side.
- Release the IM guide adjustment knob.
- Lock the Telescoping Boom by tightening the knurled knob on the boom.

TECHNIQUE TIP

4.A

It may be necessary to slightly rotate adjustment knob while depressing to allow boom insertion.

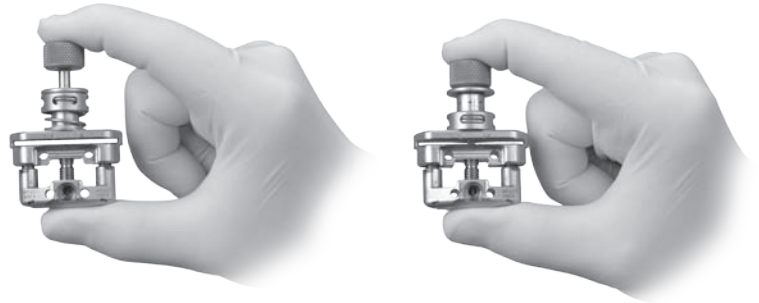

Fig.5

Push down and hold adjustment knob.

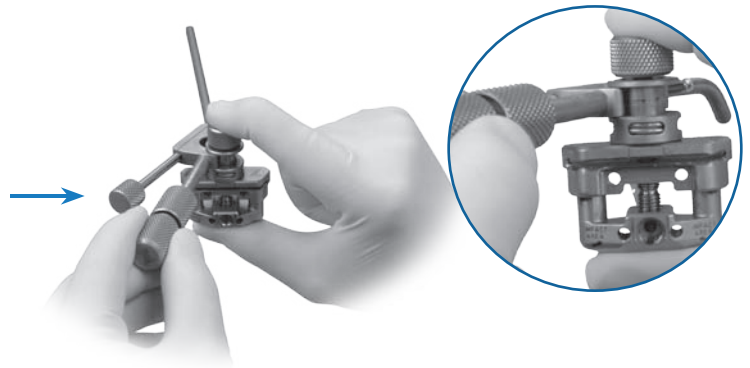

Fig.6

Slide on Telescoping Boom.

4.3 Inserting the IM Anterior Cut Guide With Telescoping Boom

- Insert the IM Guide into the medullary canal until the proximal aspect of the guide slightly contacts the distal femoral sulcus. The guide may be inserted by hand (Fig. 7) or with the Inserter/Extractor handle (Fig. 8).

TECHNIQUE TIP

4.B

To provide additional clearance for the Telescoping Boom to clear the anterior femur during insertion, adjust the IM guide to the “open” position (turning adjustment knob on top of IM guide counter-clockwise).

- If impaction is required, impact using the Inserter/Extractor handle or impact directly on the IM Anterior Cut Guide only at the location marked “IMPACT AREA” (Fig. 9).

C CAUTION: Avoid over-impacting the guide to prevent damage to the condyles.

N NOTE: Impacting the proximal aspect of the IM Anterior Cut Guide could cause instrument damage and should be avoided.

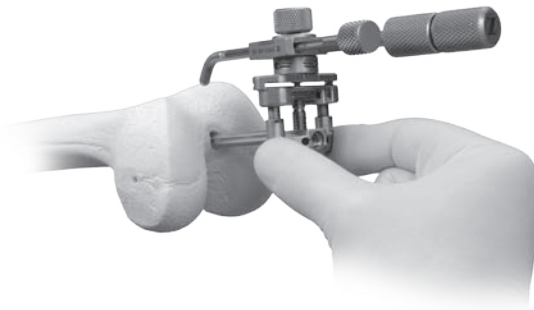

Fig.7

Insert by hand.

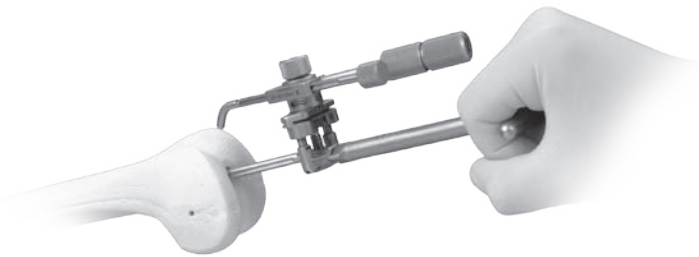

Fig.8

Optionally, insert with handle.

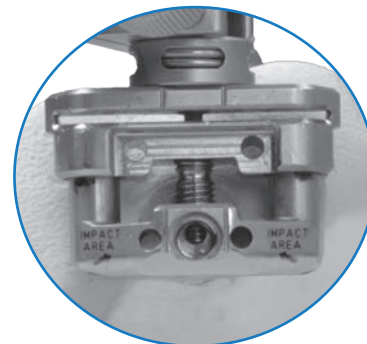

Fig.9

Impact where indicated.

4.4 Setting External Rotation and Depth for Anterior Cut

- Rotate the IM guide to the desired external rotation.
 - To align to the A/P axis, rotate the IM guide until the vertical reference lines on the guide are parallel with the A/P axis.
 - If using transepicondylar axis or line perpendicular to the A/P axis, rotate until the horizontal lines on the guide are parallel to the marked lines. (Fig. 10).

TECHNIQUE TIP

4.C

Moving the knee closer to extension will improve visibility of the anterior femur.

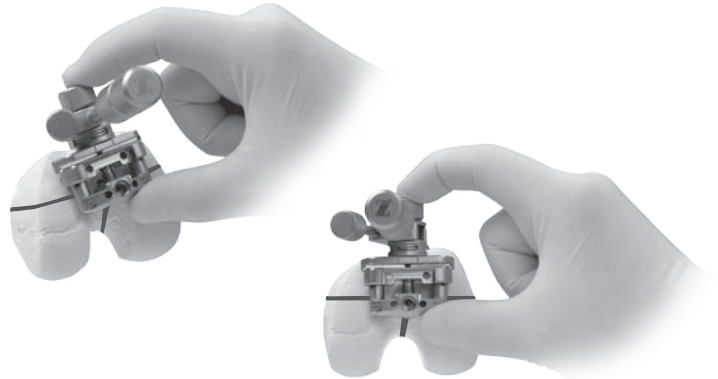
Fig. 10

Setting external rotation parallel to marked lines.

- Extend the knee and move the Telescoping Boom tip onto the lateral facet of anterior cortex (to help avoid notching).
 - The goal is to create a flush cut with the anterior cortex. (Fig. 11).

Fig. 11

Creating a "flush" cut.

- Adjust A/P height of the cut guide by turning the IM guide adjustment knob until the boom tip just contacts the cortex (Fig. 12).

N NOTE: Avoid excessive pressure on the boom tip.

- Confirm anterior cut with the Resection Guide (Fig.13).

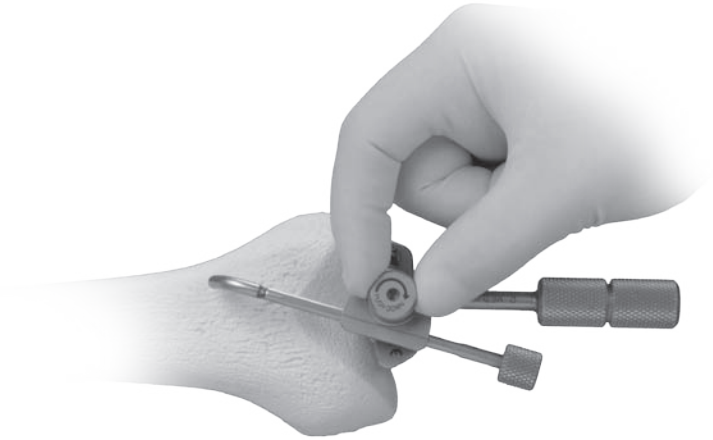

Fig. 12

Adjusting height of cut guide.

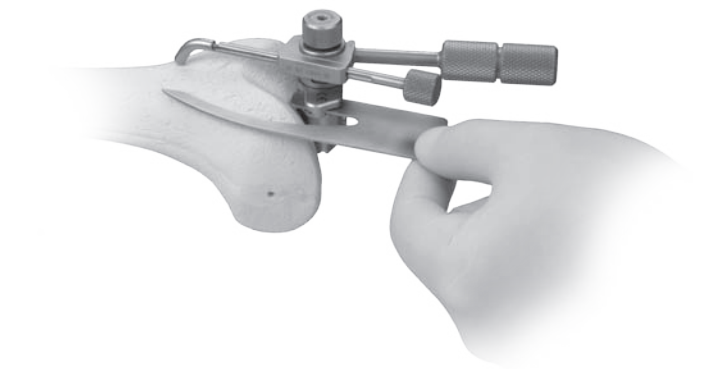

Fig. 13

Confirm anterior cut.

4.5 Securing the Guide and Making the Anterior Cut

- Secure the cut guide to the femur with three 33mm MIS *Quad-Sparing™* Headed Screws.
- Sequentially tighten the screws (at least one of the screws must be inserted in an anterior screw hole) (**Fig.14**).

TECHNIQUE TIP

4.D

To maintain screw purchase and avoid mal-positioning of the guide, do not over-tighten the screws.

- It is recommended to recheck the planned resection with the Resection Guide in case movement occurred during screw insertion.



Fig. 14

Sequentially tighten screws.

- Remove the Telescoping Boom.
 - Loosen the locking knob on the boom and slide the boom off the IM Anterior Cut Guide (**Fig. 15**).

N **NOTE: Failure to remove the Telescoping Boom before cutting will result in damage to the IM Anterior Cut Guide.**

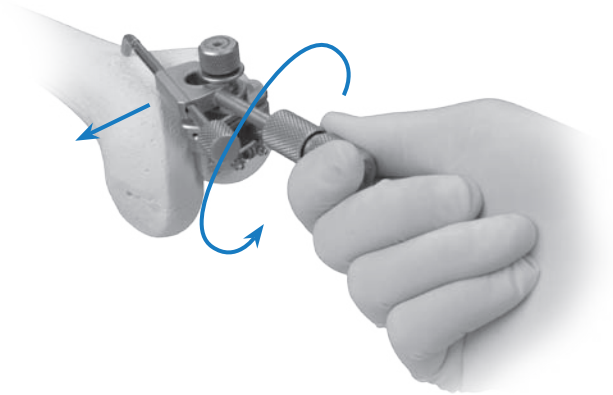

Fig. 15

Loosen locking knob and remove Telescoping Boom.

- Make anterior cut with an oscillating saw (**Fig. 16**).

N **NOTE: Recommended saw blade is 19mm (.75 inch) width and 1.27mm (.050 inch) thick (standard thickness).**

- Remove the screws from the guide.
- Attach the Inserter/Extractor handle to remove IM Anterior Cut Guide from the femur.
 - Attach the slaphammer to the end of the Inserter/Extractor handle to aid in removal if needed.

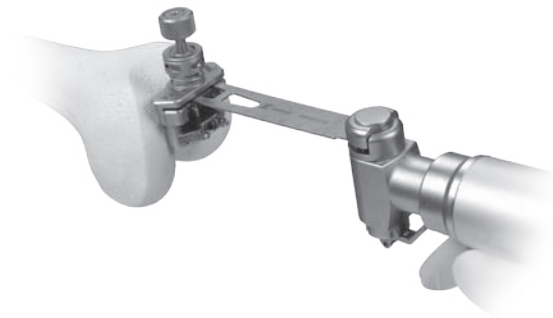

Fig. 16

Make anterior cut.

SIZE FEMORAL TROCHLEA

5.1 Milling Guide Set-up and Positioning

N **NOTE:** The Milling Guides are designed to match the outside geometry of the implant and therefore serve as sizing guides (Fig. 17-18).

- Select the appropriate size and side Milling Guide (Left or Right).
- Move the feet to the middle or “set” position as described below.



Fig. 17/18

Milling guides match the implant geometry and serve as sizing guides.

- Depress and hold the spring-loaded button while pulling up or down on each foot until each foot is in the “set” position (Fig. 19).
- Tug slightly on the foot without the button depressed to ensure the foot is locked.
- When the feet are in the “set” position the gold band will **not** be visible.

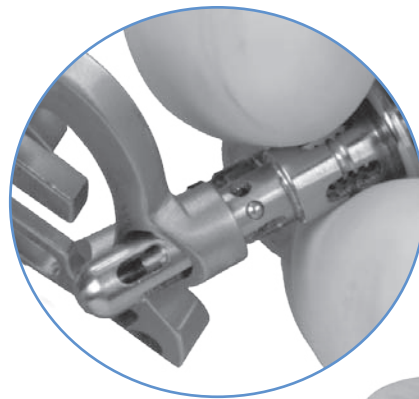

“Set” Position

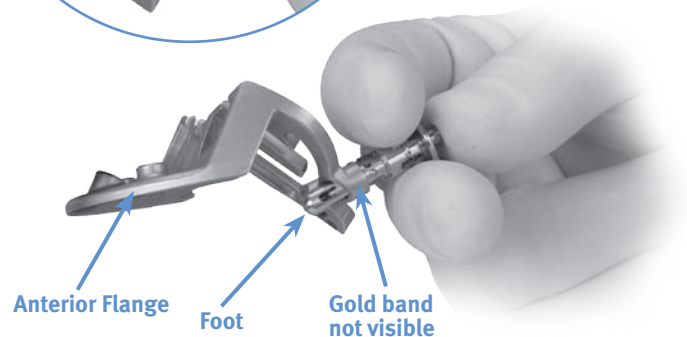

Fig. 19

Adjust feet to “set” position.

- Ensure the anterior flange and two feet of the guide are simultaneously in contact with femur during this step (Fig. 20).

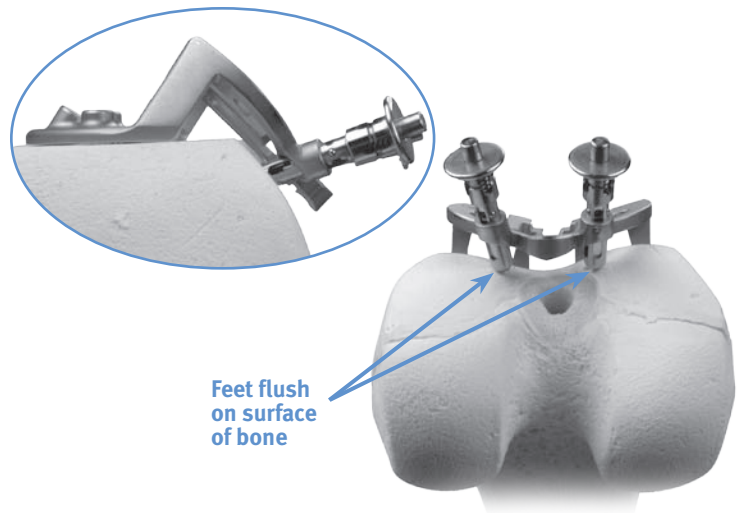

Fig. 20

Correct orientation of Milling Guide for sizing.

- If necessary, reposition Milling Guide both mediolaterally and in varus/valgus until the desired location on the femur is determined. (see section 5.2) (Fig. 21).

C **CAUTION:** Incorrect sizing will result if the feet are not in the “set” position and the anterior flange and feet are not in contact with the femur. See examples of correct and incorrect positioning (Figs. 22-24).

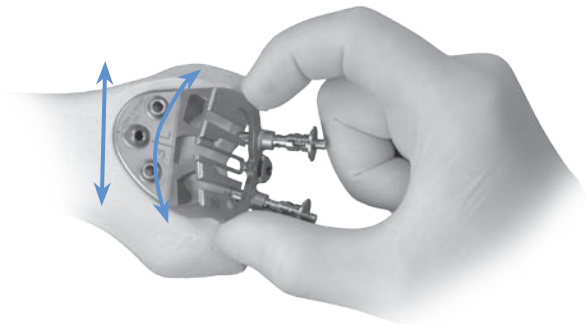

Fig. 21

Determine desired location on femur.

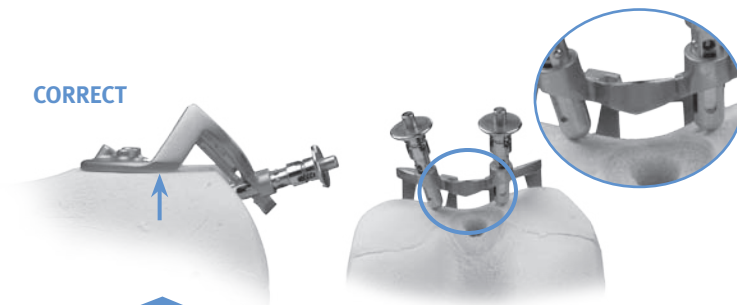

Fig. 22

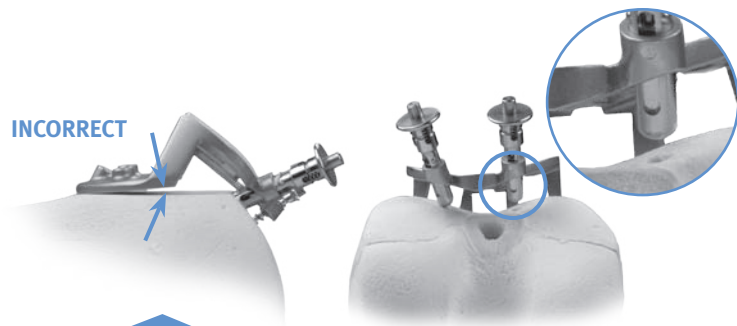

Fig. 23

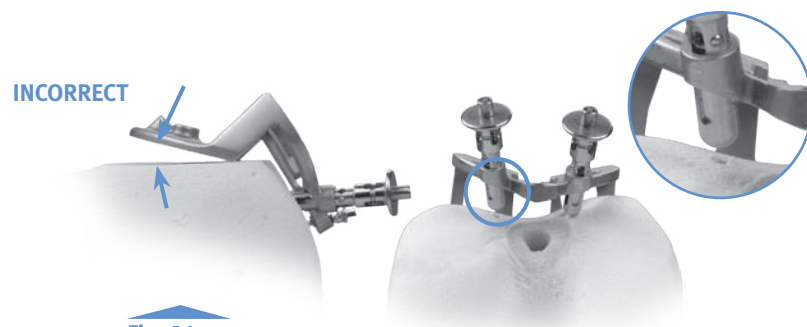

Fig. 24

Correct and incorrect set/sizing position (Fig. 25).

5.2 Trochlear Component Size Determination

- With the Milling Guide positioned properly as described previously, select the trochlear component size by evaluating the following:
 - Mediolateral Coverage:
 - Anterior flange should cover anterior cut without overhang. A small amount of underhang/clearance is acceptable (**Fig. 25**).



Fig. 25

Flange should cover anterior cut without overhang.

- The engraved line on the Milling Guide and the central milling track represents the location of the patellofemoral track on the implant and may be used as reference (**Fig. 26**).

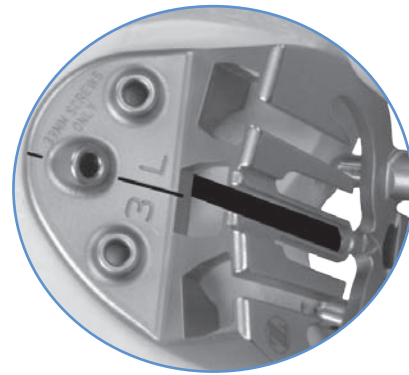

Fig. 26

Use engraved line and central milling track as placement reference.

N NOTE: Mediolateral widths of the implants are in 4 to 5mm increments (**Fig. 27**).

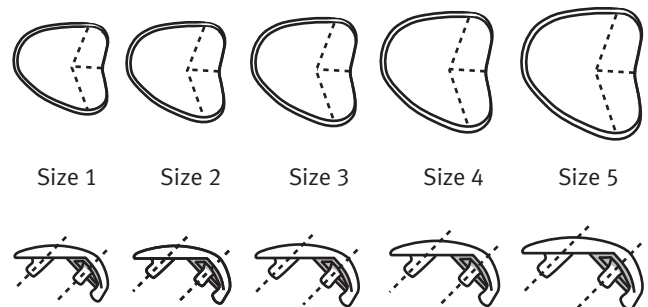

Fig. 27

Sizes in 4 to 5mm increments.

- Anterior Bone Coverage:

- Ensure acceptable proximal coverage.
- The anterior flange increases in length with increasing implant size.

- Intercondylar Notch Clearance:

- Ensure the implant will not overhang into the intercondylar notch.
- Approximate the clearance to the notch by inserting the Resection Guide into the tail verification slot of the Milling Guide (Fig. 28). The Resection Guide shows the implant's most distal articulating surface ("tail").



Fig. 28

Ensure no overhang of intercondylar notch.

- If the desired implant size is confirmed, proceed with the next step.
- Otherwise, select the next appropriately sized Milling Guide and repeat the above steps (5.1-5.2) until the desired size is chosen.

Mill Femoral Trochlea

6.1 Secure the Milling Guide

- Ensure the Milling Guide anterior flange is flat on the resected anterior bone cut with both feet in contact with the femur.
- The feet must be in the “set” position as described in section 5.1.

C CAUTION: Failure to set both feet in direct contact with the cartilage will result in shallow bone preparation and distalization of the implant, leaving it proud relative to the condylar articular cartilage. This can result in patellar catching and snapping at the transition point. Care should be taken to avoid driving the feet too deep into the cartilage as this would result in proximalization of the implant, leaving it recessed excessively. The intention is to have the trochlear implant flush to 1mm recessed relative to the condylar cartilage. This will be achieved when both feet are just touching the condylar cartilage.

- Insert three 33mm MIS *Quad-Sparing* Headed screws (00-5893-040-33) in the anterior flange of the guide.
- Tighten the screws sequentially in the following order:
 - Central oblique screw (Fig. 29)
 - Lateral screw (Fig. 30)
 - Medial screw (Fig. 31)
- Use of the 33 mm screws will prevent violation of the posterior cortex.

TECHNIQUE TIP

6.A

To maintain screw purchase and avoid mal-positioning of the guide, do not over-tighten the screws.

- Re-verify the Milling Guide feet are touching cartilage and the anterior flange is resting flat on the anterior cut before proceeding.
 - To reposition (if needed), remove the screws and repeat the above steps.

Central oblique screw

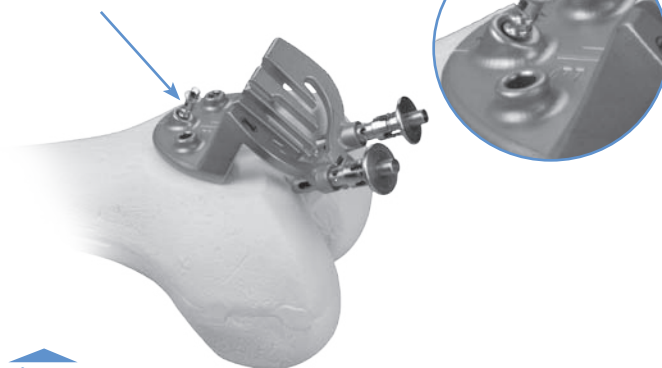

Fig. 29

Tighten central oblique screw.

Lateral screw

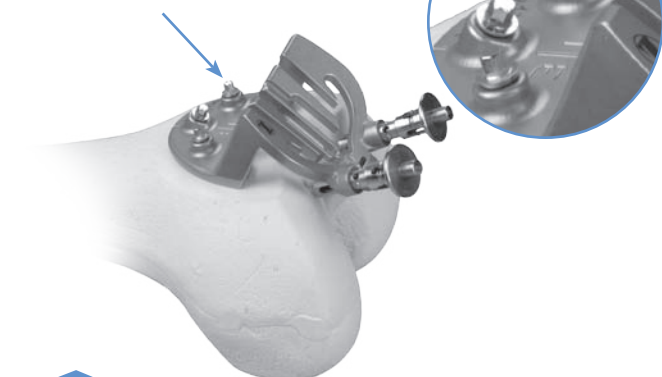

Fig. 30

Tighten lateral screw.

Medial screw

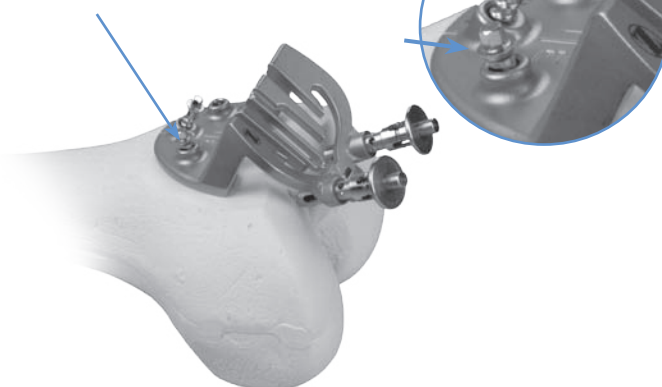

Fig. 31

Tighten medial screw.

6.2 Perform the Milling Operation

- Open Collet on Milling Handpiece: Unlock the burr locking mechanism by rotating the locking collar into the “open” position (a click can be felt as the collet fully opens).
- Install PFJ Mill Burr (00-5927-050-00): Insert burr fully into collet until flush (Fig. 32).

TECHNIQUE TIP

6.B

If burr does not sit flush initially, make sure collet is unlocked and rotate burr while inserting.

- Lock Collet: Rotate the locking collar into the “lock” position (a click can be felt when fully secure, and the “red” dots will be aligned) (Fig. 33).
- Tug slightly on burr to ensure it is fully locked.

N **NOTE:** If the Milling Handpiece is inoperable, refer to the Milling Handpiece operating instructions for trouble shooting (packaging insert or brasselerusamedical.com). If after trouble shooting the mill remains inoperable, use a second Milling Handpiece. Refer to Appendix A for the backup milling procedure if a second Milling Handpiece is not available.

- When operating the Milling Handpiece, take care to place the slotted end (burr guard) into the track before initiating power on the handpiece (Fig. 34).

! WARNING: The Milling Handpiece should only be operated when engaged in the Milling Guide. Serious injury could occur if instructions are not followed.

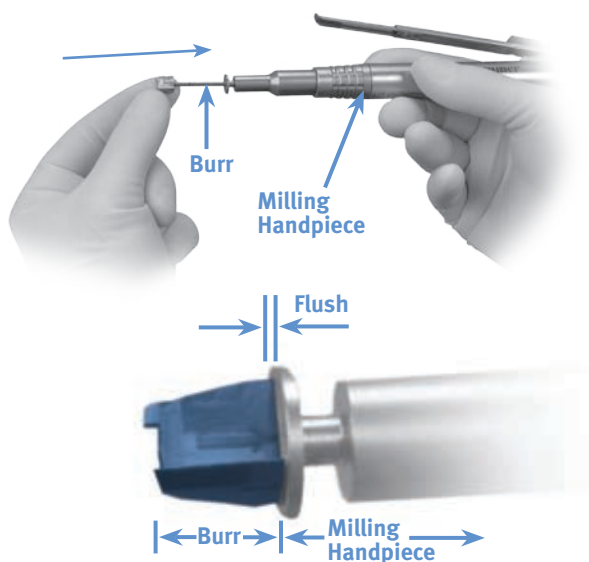
Fig. 32

Insert burr into collet.

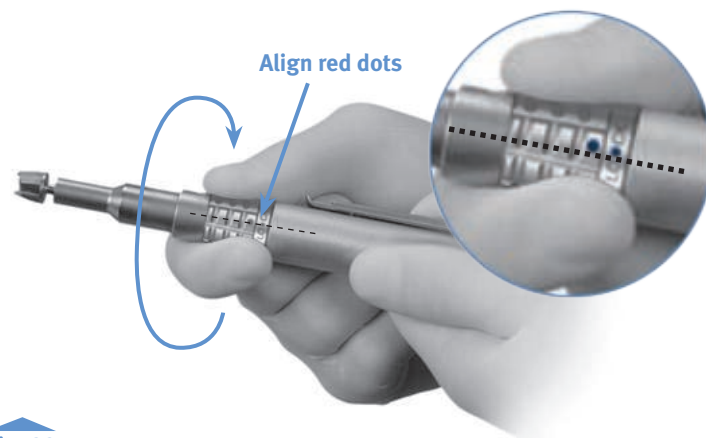
Fig. 33

Rotate locking collar into "Lock" position.

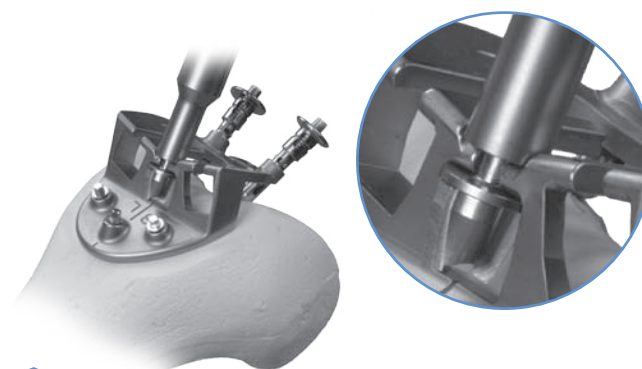
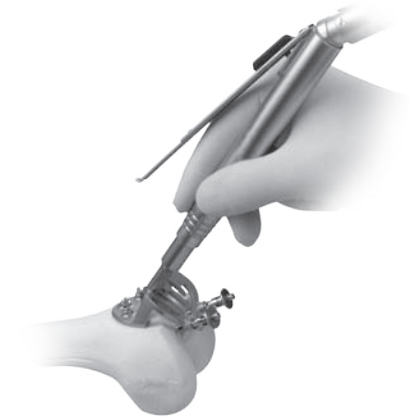

Fig. 34

Place burr guard into track before initiating power.

- Guide the Milling Handpiece with a hand on the lower half of the handpiece, similar to holding a pencil (**Fig. 35**).
- Minimize binding or toggle by keeping the Milling Handpiece perpendicular to the Milling Guide.
- Hold the hose (you or assistant) to minimize Milling Handpiece toggle.
- The tracks should be milled in the order described below.

TECHNIQUE TIP**6.C**

Run the Milling Handpiece at full throttle. If it stalls at any point, proceed more slowly through the tracks. Irrigation is not necessary with this device, but may be used if desired.

**Fig. 35**

Suggested holding position.

- Central track (**Fig. 36**)

- Apply slight and steady downward pressure while progressing distally along the central track.
- Be sure to mill the full length to the distal extreme of the central track.
- After central track milling is complete, disengage the throttle lever prior to exiting the track.

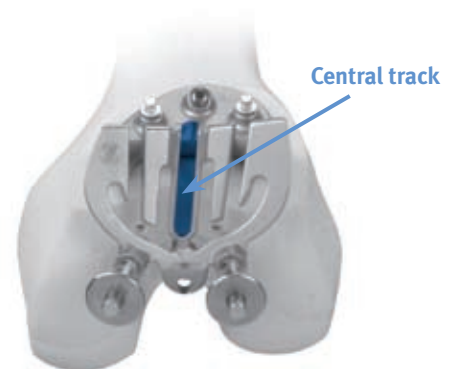
**Fig. 36**

Milling the central track.

- Lateral tracks

- o Depress and hold spring-loaded button on the lateral foot.
- o Pull up until stop is reached and release the button. (“Mill” position – The gold band should be visible above guide) (Fig. 37).
- o This will allow the Milling Handpiece to pass under the raised foot.

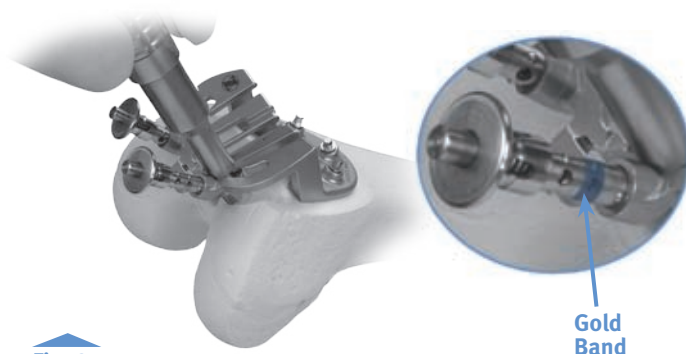

Fig. 37

Lateral foot in “mill” position.

N NOTE: Failure to raise the foot to the “Mill” position will result in damage to the Milling Guide and Burr.

TECHNIQUE TIP

6.D

If the Milling Handpiece appears to “stick” in area near feet, make sure foot is **fully** raised.

- o Mill the entire lateral track (all tracks in the lateral zone) (Fig. 38).
- o After milling the lateral tracks, disengage the throttle lever prior to exiting the track.

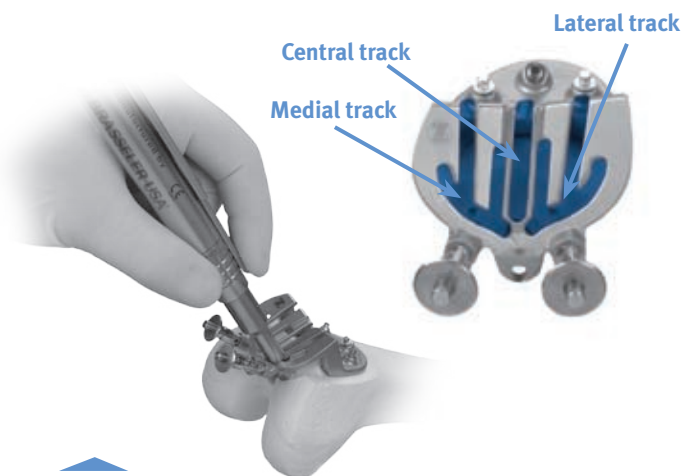

Fig. 38

Mill all lateral tracks.

- o Depress the button and push the lateral foot into its down or “Stabilize” position (gold band visible below the guide) (Fig. 39).
- o The lateral foot will now be resting on the resurfaced bone ensuring stability of the guide when milling the opposing track.

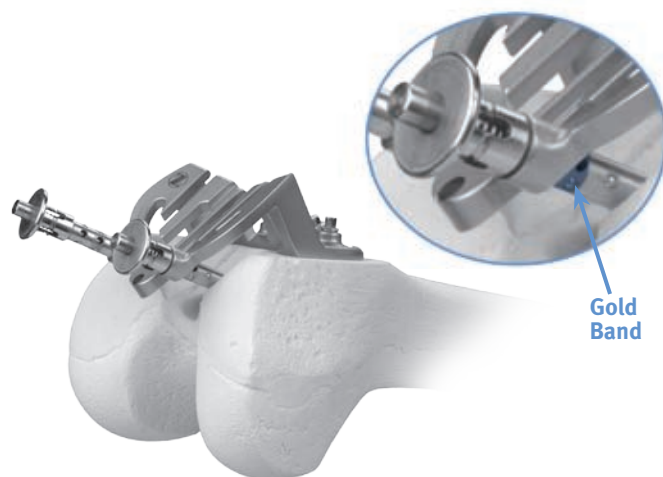

Fig. 39

Lateral foot in “stabilize” position.

- Medial tracks

- Depress and hold spring-loaded button on the medial foot.
- Pull up until stop is reached and release the button. (“Mill” position – The gold band should be visible above guide) (Fig. 40).

N NOTE: Failure to raise the foot to the “Mill” position will result in damage to the Milling Guide and Burr.

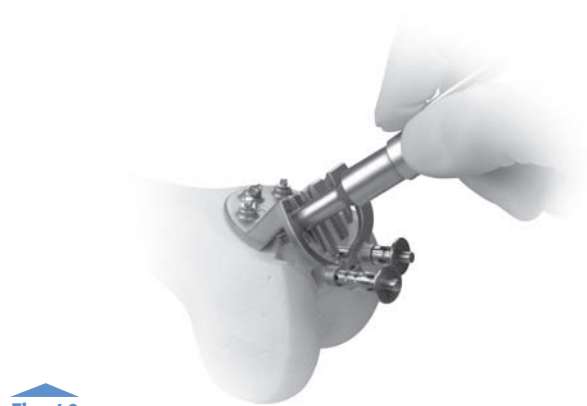

Fig. 40

Medial foot in “mill” position.

- Mill the entire medial track (all tracks in medial zone) (Fig. 41).
- After milling the medial tracks, disengage the throttle lever prior to exiting the track.
- Return throttle safety slide to “safe” or full forward position.
- Make sure that all paths of the distal bone preparation have been milled.
- Remove the screws and the Milling Guide and irrigate to remove all bone and cartilage debris.

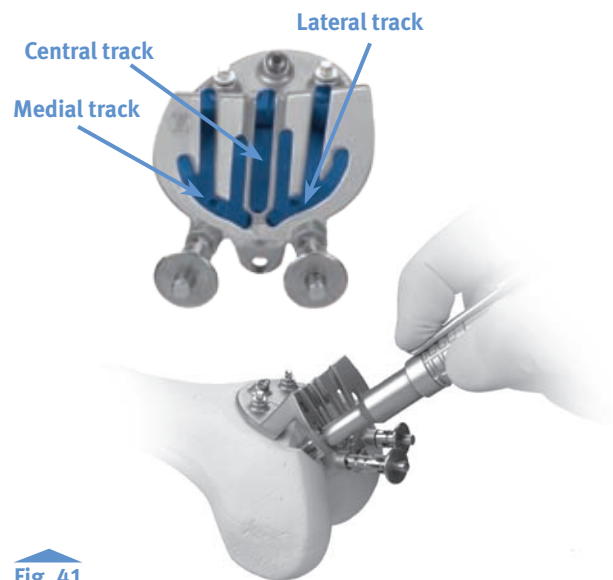

Fig. 41

Mill all medial tracks.

- The bone preparation should appear as illustrated (Fig. 42).
- Please note that a small area of bone may remain distally but will be removed during the tail preparation.
 - Freehand removal is not recommended.

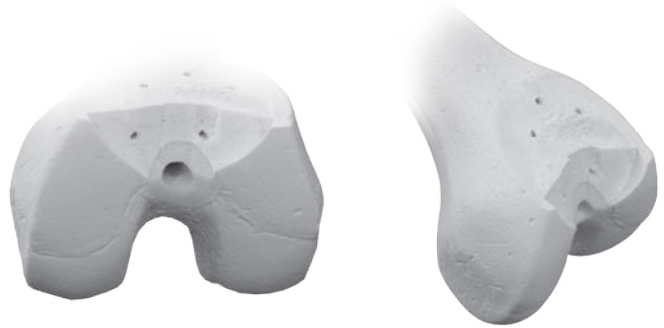

Fig. 42

Bone Preparation

Drill Peg and Tail Holes

- Select the appropriate size Peg/Tail Guide (Left or Right).
 - The Peg/Tail Guides match the outside geometry and inlayed thickness of the trochlear implant.
- Insert the guide in place and ensure that it is fully seated against the anterior and distal surfaces (**Fig. 43**).

TECHNIQUE TIP

7.A

Apply pressure distally on the guide until the guide is against the prepared distal ledges.

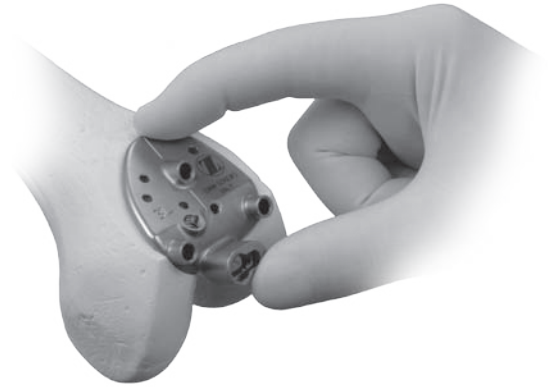
Fig. 43

Make sure guide is fully seated against distal surface.

- Secure it with three 33mm screw(s) and tighten sequentially (**Fig.44**).
 - Use of the 33mm screw(s) will prevent violation of the posterior cortex.

TECHNIQUE TIP

7.B

To maintain screw purchase and avoid malpositioning of the guide, do not over-tighten the screws.

C CAUTION: The Peg/Tail Guide outside geometry matches the implant, and therefore placement of the guide is critical.

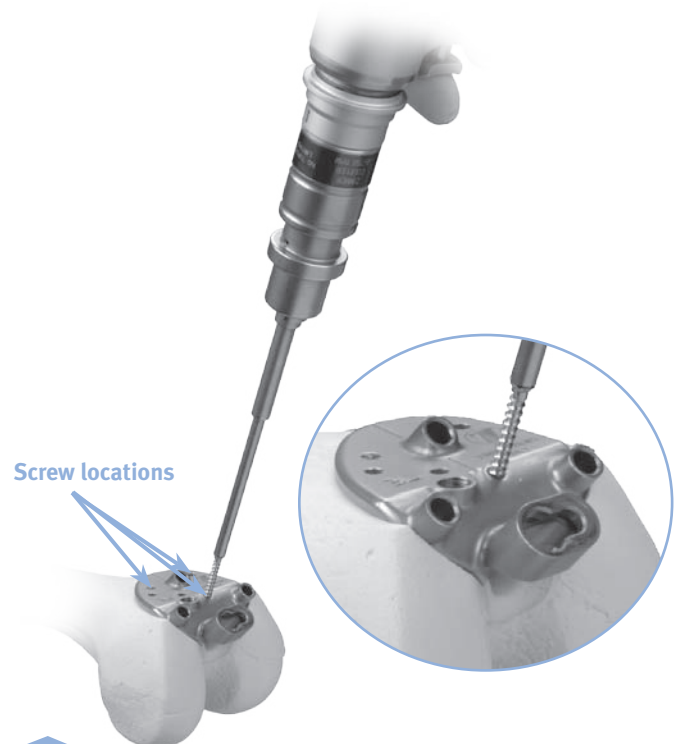
Screw locations
Fig. 44

Sequentially tighten using 33mm screws.

- Drill the anterior, medial, and lateral peg holes (Fig. 45).

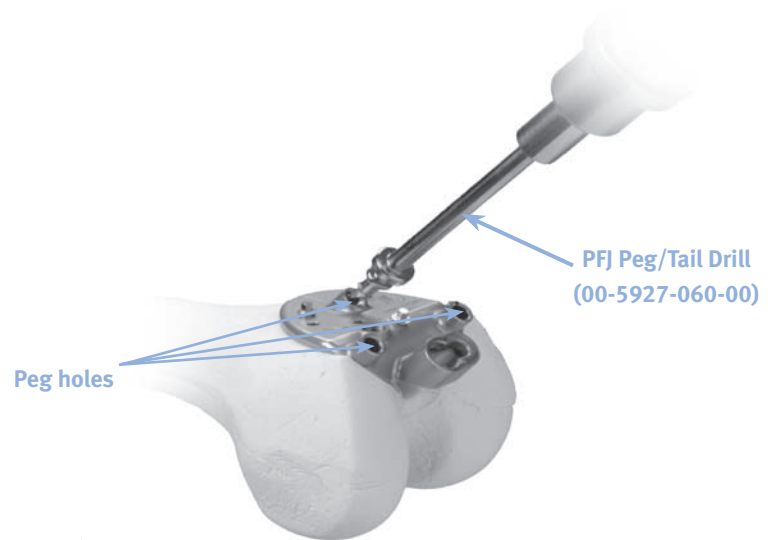

Fig. 45

Drill peg holes.

- Drill the full depth until the shoulder of the drill stops against the boss for each peg hole (Fig. 46).



Fig. 46

Shoulder of drill stops against each boss.

- Drill the tail slot (distal oval peg) by:
 - Insert the drill into the entry hole on the left of the guide (Fig. 47).



Fig. 47

Drill the tail slot (distal oval peg).

- Once the upper shoulder on the drill reaches the boss on the guide, continue drilling while sliding the drill from left to right.
 - o The drill's upper shoulder must remain flush with the guide's boss.

TECHNIQUE TIP

7.C

Applying pressure (drill shaft) to the right with a finger may aid the drill movement (Fig. 48). Take care to prevent glove from catching.

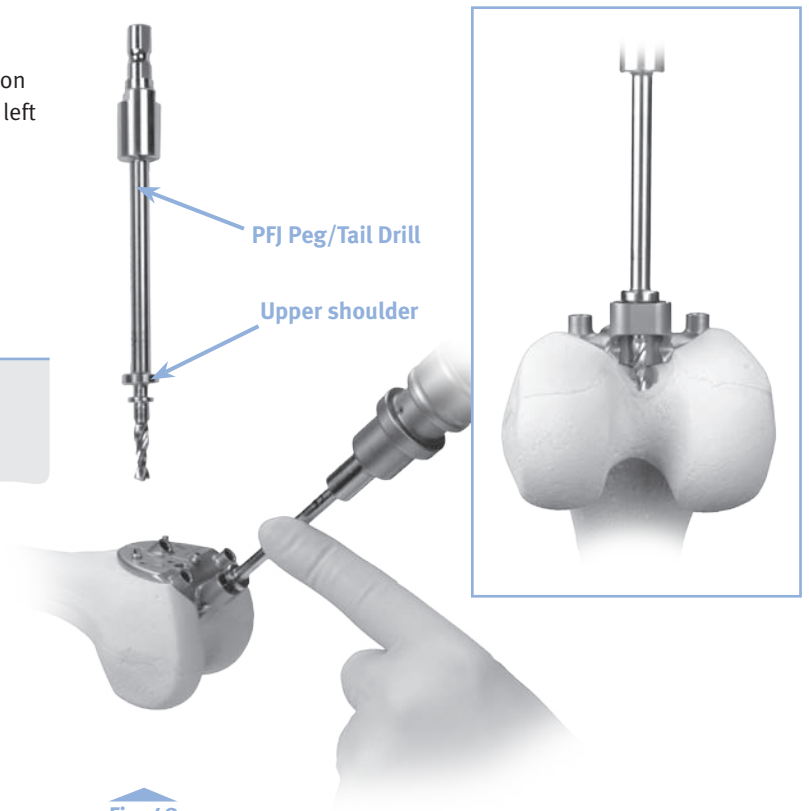

Fig. 48

Apply pressure to aid side-cutting action.

Perform Trial Reduction

- Attach the Inserter/Extractor Handle to the appropriate size PFJ Provisional (Left or Right) (**Fig. 49**).

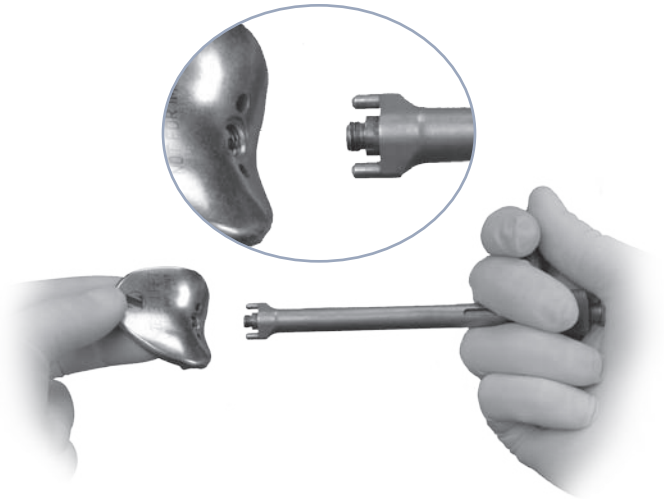

Fig. 49

Attach Inserter/Extractor handle.

TECHNIQUE TIP

8.A

The provisional can be inserted onto the femur by hand if desired (Fig. 50).



Fig. 50

Optionally, insert provisional by hand.

- Insert the provisional onto the femur, taking care to properly align the pegs and tail with the holes (**Fig. 51**). The pegs should engage into peg holes at the same time.
- Once inserted in place, remove the Inserter/Extractor Handle and impact the provisional with the PFJ Impactor until it is fully seated.
 - The impaction force should be delivered in the direction of the pegs' axis (**Figs. 51,52, and 53**).

C **CAUTION:** Some press-fit may be necessary to ensure an optimal fit, but be careful to avoid impinging or damaging cartilage at the transition area during impaction.

CORRECT

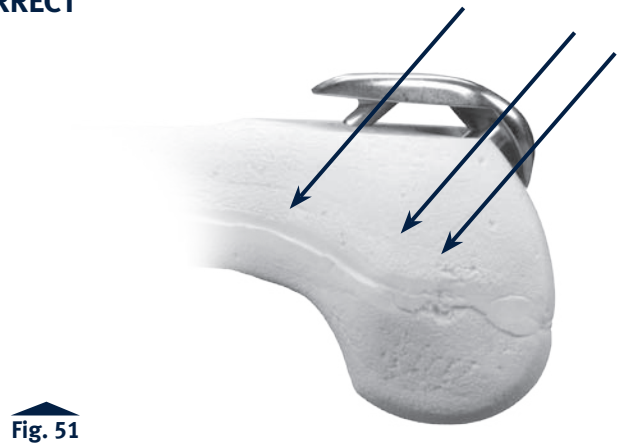

Fig. 51

INCORRECT



Fig. 52

INCORRECT



Fig. 53

Correct and incorrect insertion angles.

- Insert the appropriate Patella Provisional selected in Section 2.
- Evaluate patellofemoral tracking throughout range of motion.

NOTE: The patella should transition smoothly throughout range-of-motion.

TECHNIQUE TIP

8.B

If necessary, remaining cartilage at the edge of the anterior cut shown circled in Fig. 54, in particular sharp corners, may be blended to prevent soft tissue irritation. Also, areas around the patella may be blended to prevent impingement and provide for smoother contact.

- Remove the Patella Provisional.
 - Attach the Inserter/Extractor handle to the PFJ Provisional (trochlea) (Fig. 55).
 - Carefully remove the provisional in the direction of the pegs' axis.
 - Attach slaphammer to the end of the Inserter/Extractor handle to aid in removal.
- CAUTION:** Do not rock the provisional back and forth during removal as this could compromise the bone preparation, peg hole preparation, surrounding cartilage, and the implant's fit.

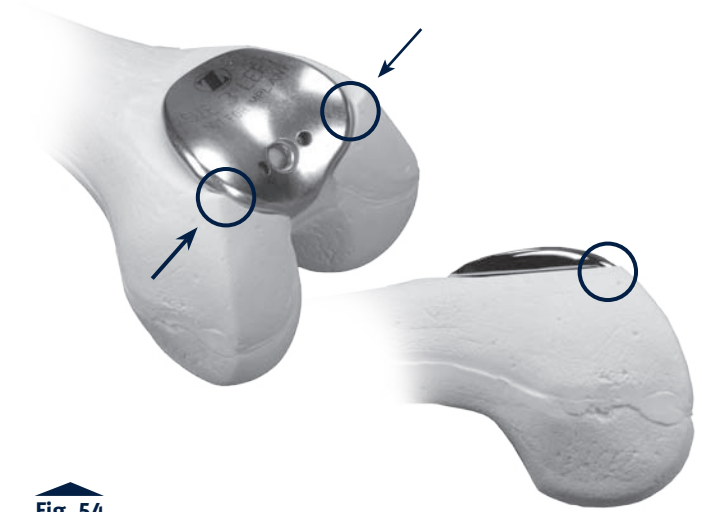

Fig. 54

Cartilage at the edge of the anterior cut may be blended.

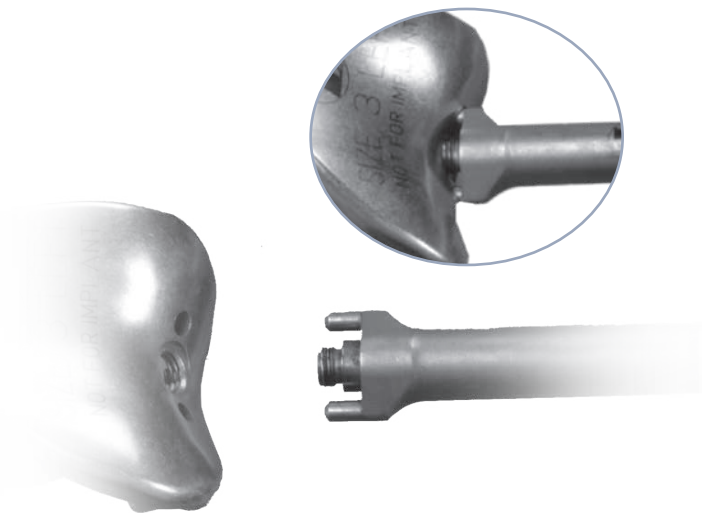

Fig. 55

Carefully remove provisional.

Implant Trochlea and Patella Prostheses

9.1 Cementing/Implanting the PFJ Implant (Trochlea)

- Select the appropriate size PFJ Implant (Left or Right).
- Apply bone cement to the undersurface of the PFJ Implant (Fig. 56) and/or femur as appropriate.

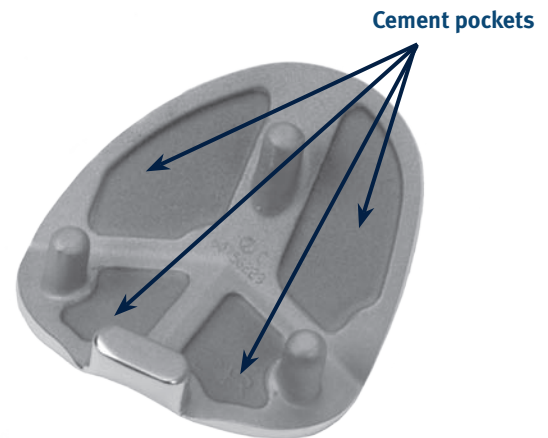

Fig. 56

Apply bone cement.

TECHNIQUE TIP

9.A

If applying cement directly to the femur, mark the location of the peg holes (push cement down into holes) to aid in positioning the implant pegs during insertion.

- Insert the PFJ Implant in place, taking care to properly align the pegs and tail with the holes.
- Once inserted in place, impact the implant with the PFJ Impactor until it is fully seated.
- The impaction force should be delivered in the direction of the pegs' axis (Fig. 57).

C CAUTION: Some press-fit may be necessary to ensure an optimal fit, but be careful to avoid impinging or damaging cartilage at the transition area during impaction.

- Carefully remove excess cement.
 - Press down on the implant with the impactor to help squeeze out excess bone cement.



Fig. 57

Impact in direction of peg's axis.

- Apply pressure on the implant until cement is cured (**Fig. 58**).

9.2 Cementing/Implanting the Patella and Checking Motion

- Insert the appropriate patella implant in place.
- Apply pressure until the cement is cured.
- Remove excess cement.
- Confirm patellofemoral tracking throughout range of motion.
 - The patella should track centrally within the trochlear groove.
 - The patella should transition smoothly from the trochlear implant to the femoral condyles through flexion and extension.
 - There should be no patellar tilt, subluxation or catching on the implant.

TECHNIQUE TIP

9.B

A lateral release can be performed for slight tilt or subluxation.



Fig.58

PFJ (Trochlea) implanted.

Bicompartmental Arthroplasty

10.1 Compatibility

- The *Zimmer Gender Solutions* Patello-Femoral Joint System is compatible with the *Zimmer* Unicompartmental Knee System and the *M/G* Unicompartmental Knee System.
- Cadaveric testing has shown that adequate clearance between the *Zimmer Gender Solutions* Patello-Femoral and a *Zimmer* Unicompartmental Knee is achieved when proper surgical technique for both prostheses are followed (**Fig. 59**).

10.2 Sequence - Implanting the Zimmer Gender Solutions Patello-Femoral Joint First

- The *Zimmer Gender Solutions* Patello-Femoral Joint System may be used with *Zimmer* Unicompartmental implants, whether combined simultaneously or in a staged approach.
- In a staged approach, the *Zimmer Gender Solutions* PFJ and *Zimmer* Unicompartmental are implanted during separate surgical interventions. The Unicompartmental may be added to an existing PFJ or the PFJ may be added to an existing Unicompartmental.
- In a simultaneous approach, the *Zimmer Gender Solutions* Patello-Femoral Joint and *Zimmer* Unicompartmental Knee are implanted during the same surgical intervention. In this presentation, it is recommended that the *Zimmer Gender Solutions* Patello-Femoral Joint be implanted first. This sequence enables proper placement of the PFJ Milling Guide for resurfacing of the trochlea.

10.3 Unicondylar Technique

- The *Zimmer* Unicompartmental components should then be implanted using their respective surgical techniques. The Spacer Block Option is recommended when using the *Zimmer* Unicompartmental Knee System combined with the *Zimmer Gender Solutions* PFJ.

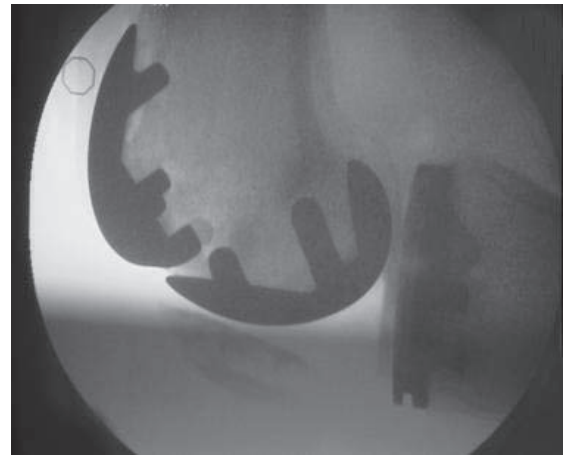

Fig. 59

- **CAUTION:** Cleanse surgical site of bone chips, bone cement, or other debris as foreign particles at the articular interface may cause excessive wear.
- Suture/close

Appendix A: Backup Milling Procedure Rationale:

The PFJ Drill Milling Adapter can be used to complete the milling operation in the event the Milling Handpiece is inoperable at the time of surgery. The Drill Milling Adapter joins the PFJ Mill Burr to a standard surgical drill via a Jacob's Chuck and utilizes a PFJ Milling Guide for accurate bone preparation. *The milling operation is more challenging when using this approach and should only be used as a backup to the Milling Handpiece.*

1. Assembly:

Insert new PFJ Mill Burr (00-5927-050-00) into the PFJ Drill Milling Adapter as shown in (Fig. 1).

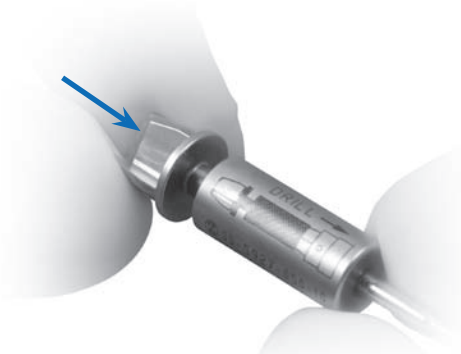

Fig. 1 Insert burr into adapter

With a 1/4 in. or smaller Jacob's Chuck facing upright, insert the shank of the PFJ Mill Burr with PFJ Drill Milling Adapter into the Jacob's Chuck until they both bottom out (Fig. 2). Tighten securely with chuck key (Fig. 3). Rotate assembly to visually verify that the burr is clamped straight and that the PFJ Drill Milling Adapter rotates independently from the PFJ Mill Burr.



Fig. 2 Burr and adapter in Jacob's Chuck

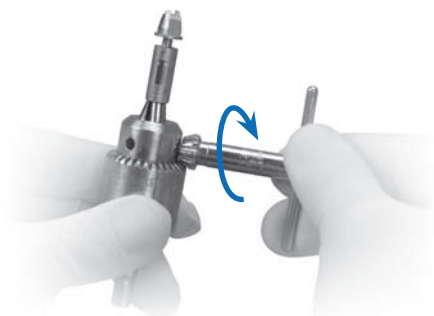

Fig. 3 Tighten Jacob's Chuck securely

Caution: To minimize the potential for over-resection, hold Jacob's Chuck vertically during tightening and ensure there is no axial play in the assembly (Figs. 4 & 5).



Fig. 4 Backup Milling Assembly (CORRECT)



Fig. 5 Backup Milling Assembly (INCORRECT)

Place Backup Milling Assembly into a standard surgical drill.

Caution: The use of a reamer/wire driver is not recommended. Ensure the standard surgical drill/Jacob's Chuck can achieve 750-25,000 rpm. Too slow/fast may result in poor bone preparation and/or damage to the instruments.

2. Secure the Milling Guide: Additional Fixation

In addition to the three (3) anterior fixation screws, it is recommended to utilize a 48mm MIS headless screw (00-5983-041-48) in the Milling Guide's posterior fixation hole when using this approach. This will help ensure adequate fixation (Fig. 6).



Fig. 6 Posterior screw insertion

Caution: Avoid tilting the sharp tip of the screw into extension and/or medially to avoid contact with the posterior cruciate ligament (Fig. 7).

Caution: If a 48mm MIS **headed** screw is utilized, do not tighten the screw head against the PFJ Milling Guide (Fig. 8). This may result in improper resection by forcing the guide closer to the bone.

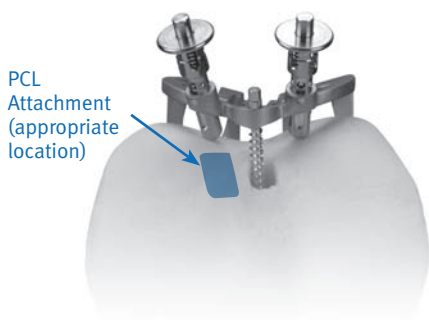

Fig. 7 Proper screw orientation



Fig. 8 Posterior screw head not bottoming

Perform the Backup Milling Operation:

Refer to section 6 in the Gender Solutions Patello-Femoral Joint System surgical technique for order of track milling and feet positions with the following additional instructions:

Guide the PFJ Drill Milling Adapter with a hand on the lowest portion of the standard surgical drill (Fig. 9).



Fig. 9 Guiding Drill Milling Adapter

Caution: Drill Milling Adapter may become warm or intermittently spin during usage. Use caution when touching.

Enter the Milling Guide by placing the slotted end of the PFJ Drill Milling Adapter into the tracks similar to the approach when using the Milling Handpiece (Fig. 10).

WARNING: Serious injury could occur if the adapter is not fully engaged in the tracks. Initiate power only when engaged in the Milling Guide.



Fig. 10 Place PFJ Drill Milling Adapter into track before initiating power

Proceed slowly through the milling tracks. This will reduce the potential for binding or bending of the PFJ Drill Milling Adapter and PFJ Mill Burr. Keep the PFJ Milling Adapter perpendicular to the Milling Guide in order to minimize binding or toggle.

After milling each track (1. central, 2. lateral, 3. medial), verify that the Jacob’s Chuck is properly secured to the PFJ Mill Burr shank and that the Milling Guide is rigidly fixed to the femur as loosening may occur.

Caution: To avoid over-resection, check for axial burr migration during milling and after each track is complete.

If the Jacob’s Chuck interferes with the Milling Guide Foot or gets stuck in the track, ensure that the PFJ Drill Milling Adapter is perpendicular to the Milling Guide and then continue with the milling operation. Do not force.

Proceed with the remaining steps of the surgical technique. (Sections 7-11 of the Gender Solutions PFJ Surgical Technique).

Inspect the Milling Guide and PFJ Drill Milling Adapter for damage and replace as required.

Please refer to package insert for complete product information, including contraindications, warnings, precautions, and adverse effects.

Contact your Zimmer representative or visit us at www.zimmer.com



+H124975926002001/\$081106R1F09

97-5926-002-00 Rev. 1 0811-K10 5ML Printed in USA ©2008, 2009 Zimmer, Inc.