

# Re+Line® Bunion Correction System

Surgical Technique



# Re+Line<sup>®</sup>

Bunion Correction System

- Easy insertion and medial placement accuracy using Landmark<sup>®</sup> Guide technology
- 1 mm compression slot and fixed tines to encourage compression across osteotomy site
- Stable Fixation of the Metatarsal Head
- Designed to Minimize Soft Tissue Disruption

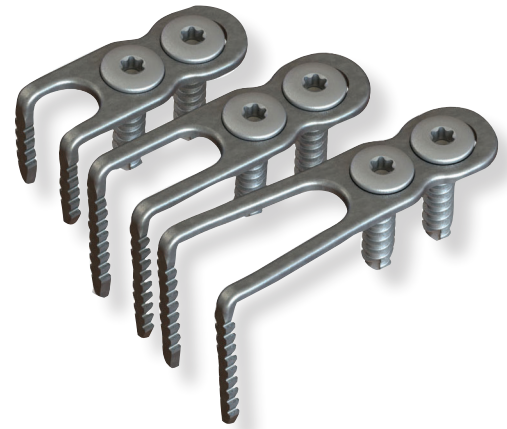

Landmark<sup>®</sup> Positioning Drill Guide 6.0mm

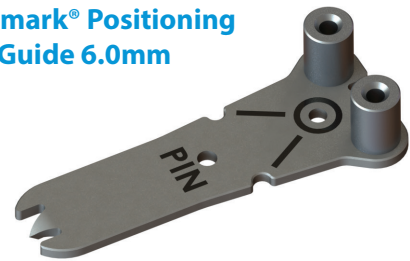

Re+Line<sup>®</sup> Bunion Correction Plate

1 mm Compression Slot

Two-Screw Fixation

Low Profile, 1 mm

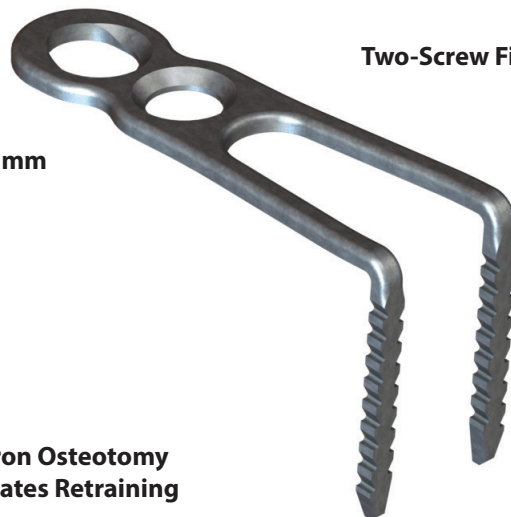

Alternating Side Teeth on Tines for Anchoring and Even Load Distribution

Conventional Chevron Osteotomy Compatible - Eliminates Retraining

# Re+Line®

Bunion Correction System

## Re+Line® Bunion Correction System Sterile Procedure Kit

- Sterile, OR-ready instrument and implant systems
- Designed for repeatable outcomes
- Single use, optimized for OR efficiency

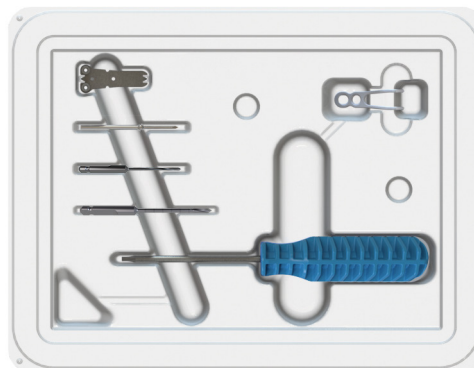

The Re+Line Bunion Correction System is manufactured using 316 Stainless Steel.

Each kit contains one  
two-screw Re+Line® Bunion  
Correction Plate

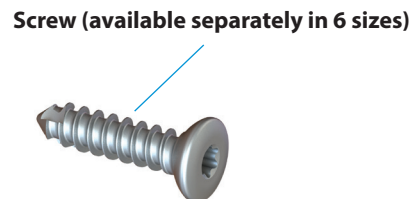
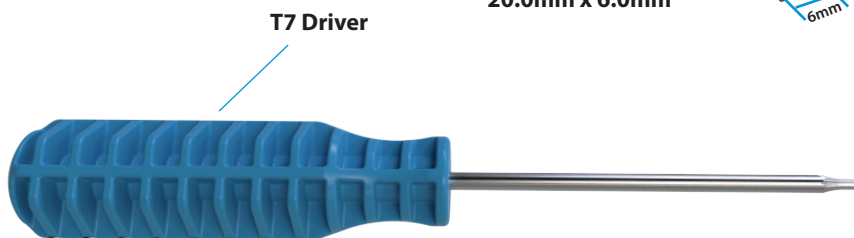
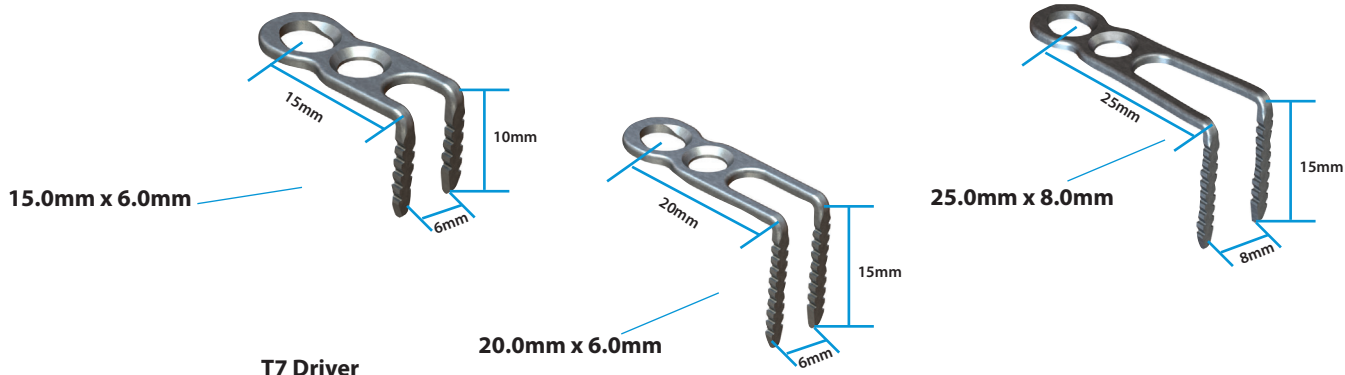

Landmark® Positioning  
Drill Guide 6.0mm

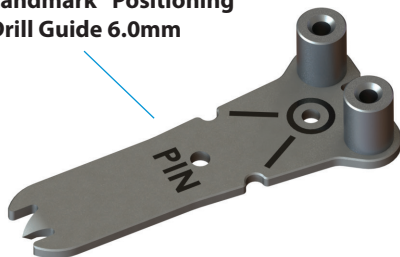

Temporary Pin



1.4mm AO Drill



2.0mm AO Drill



# Surgical Technique - Chevron

## 1. Sizing the Implant

Prior to surgery, assess pre-op x-ray to determine implant size.

The size of the Re+Line® implant is determined by the width of the resected metatarsal head and the length of the flattened metatarsal shaft. The Re+Line® implant works most effectively when placed on a flat medial surface after correction and secondary trimming. The length of the medial flat surface will vary case-by-case, but generally the greater the correction of the capital fragment, the greater the need for a longer Re+Line® implant. As long as the metatarsal head medial lateral width is wider than 15 mm, a 20 or 25 mm implant should be used. The length of the resected metatarsal shaft determines between the 20 and 25 mm implant. The 20 and 25 mm Re+Line® Bunion Correction Plates are more commonly used.

2. Prepare osteotomy site. Resect medial eminence mass as required.

*Note: To reconfirm implant length, use a surgical metric from center of metatarsal head to desired proximal fixation point.*



3. After assessing the size of the metatarsal head and deformity, open the appropriate size Re+Line® Kit. Center the Landmark® Positioning Guide on the medial side of the metatarsal head using the apex Landmark® (laser ring) as a guide.



4. Pin the Landmark® Positioning Guide to the metatarsal, proximal to the osteotomy cuts. Drill the pin to stabilize the Landmark® Positioning Guide against the metatarsal.

*Note: Fluoroscopy may be used to ensure placement. The Landmark® Positioning Guide functions as a template for the implant.*

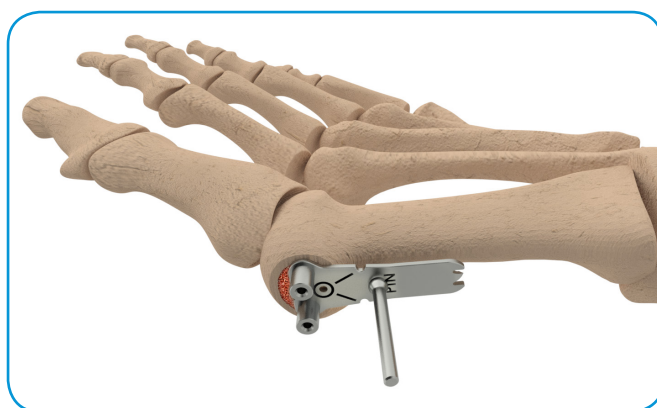

- 5.** Using the 1.4 mm AO drill the three remaining holes on the Landmark® Positioning Guide bushings.

*Note: When drilling for the tines, drill to the laser marking depth line on the AO drill. When drilling the apex hole, drill through the medial surface. Tine hole depth is 15mm when the groove is at the top of the Landmark® Positioning Guide bushing.*

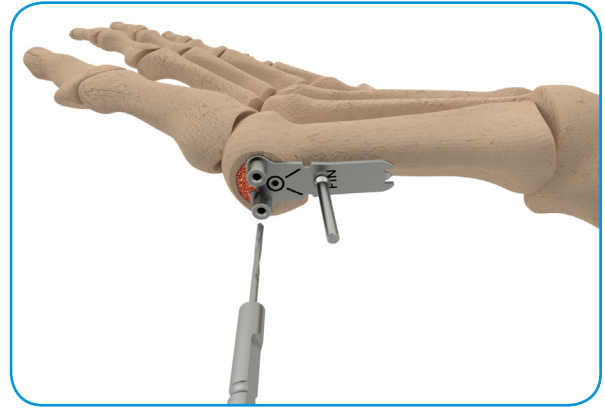

- 6.** (Optional) Mark the cutting landmark points on the metatarsal. Angle is 60 degrees between pen notches and apex hole.

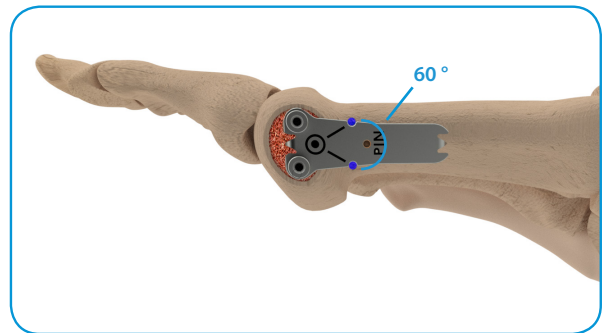

- 7.** Remove the pin used to stabilize the Landmark® Positioning Guide. Cut the Chevron osteotomy and translate. Translate the head in a lateral direction to the desired position.

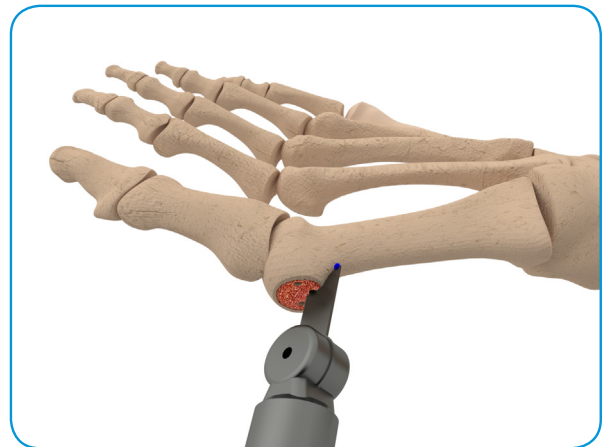

- 8.** Resect medial prominence off the metatarsal. The medial surface of the resected medial metatarsal head and metatarsal shaft should be level for proper seating of the Re+Line® Bunion Correction Plate. In order to prevent the head from moving, a distal to proximal K-Wire, inserted dorsally, may be used at this point to stabilize while cutting the redundant medial bone on the shaft.

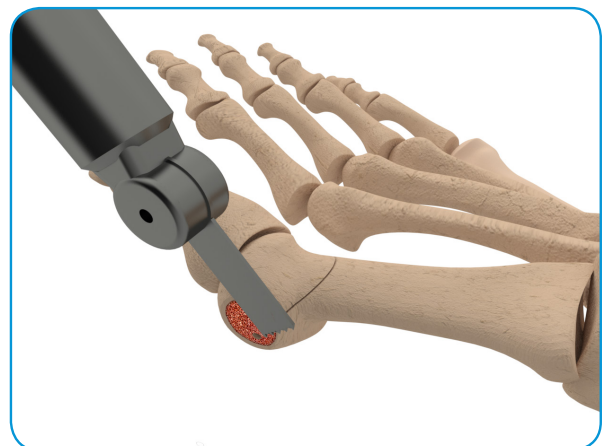



- 9.** Insert the Re+Line® Bunion Correction Plate as far as possible into the pre-drilled holes on the medial surface of the metatarsal head. In hard bone, over-drilling the tines may be necessary.
- 10.** While ensuring full reduction of the metatarsal head, maintain compression of the head at the osteotomy site on the metatarsal shaft. **The Re+Line® Bunion Correction Plate should rest as flush against the metatarsal as possible.**

*Note: Fluoroscopy may be used prior to releasing plate to ensure proper placement.*

- 11.** Using the 2 mm AO drill, drill through the proximal end of the compression slot. Ensure the 2 mm pilot hole is made as proximal as possible to the center of the slot. This will ensure proper linear compression and thus reduction of the two bone fragments. With the drill tip crossing the lateral cortex, read the length marking that corresponds to the medial surface of the Re+Line® Bunion Correction Plate to select the appropriate screw length. Once accurate screw sizing is chosen, place the screw and tighten, reducing bone fragments.

*Note: Ensure screws achieve bicortical bone purchase.*

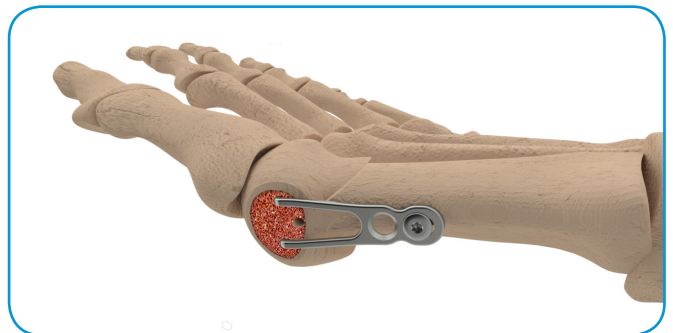
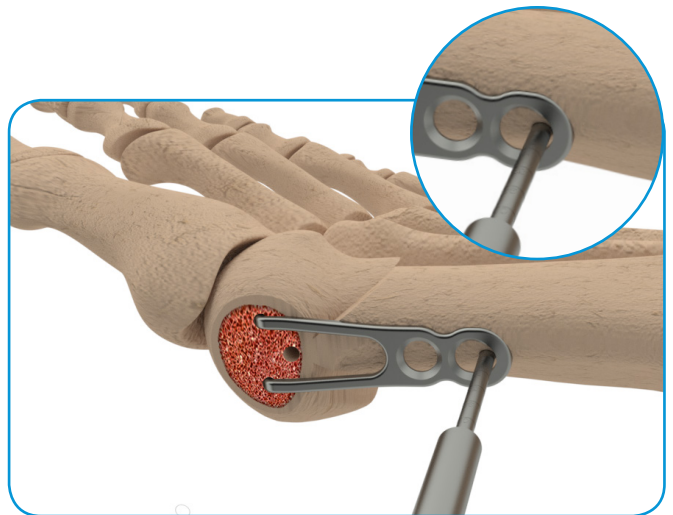
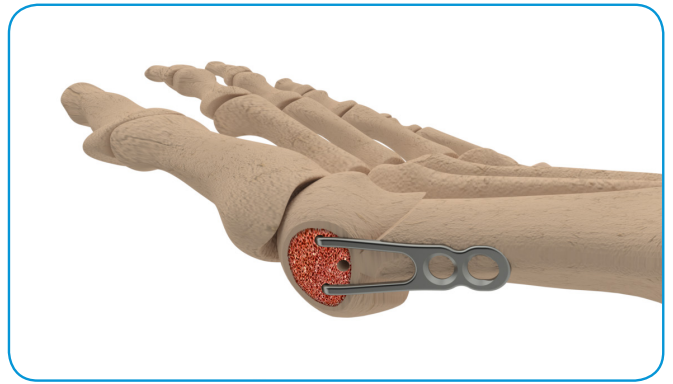

- 12.** Using the 2 mm AO drill, drill the second hole in the center of the plate; this is not for compression. After this drill hole is made and the proximal compression hole has been screwed and tightened, then insert second screw and tighten. Verify reduction, close in the usual manner.



## Alternative Surgical Technique - Other Osteotomies

With planning, the Re+Line® Bunion Correction Plate can be used with other osteotomies, including Long Arm Chevrons, Reverdin Laird, Large Correction Chevron (i.e. greater than 5 mm) to allow sufficient bone in the proximal fragment for each screw.

1. Create your osteotomy site and resect medial eminence.
2. Mark and create your osteotomy and translate.

Resect medial prominence off the metatarsal. The medial surface of the resected medial metatarsal head and metatarsal shaft should be level for proper seating of the Re+Line® Bunion Correction Plate. In order to prevent the head from moving, a distal to proximal K-Wire, inserted dorsally, may be used at this point to stabilize while cutting the redundant medial bone on the shaft.

After assessing the size of the metatarsal head and deformity, open the appropriate size Re+Line® Kit. Center the Landmark® Positioning Guide on the medial side of the metatarsal head using the apex Landmark® (laser ring) as a guide.

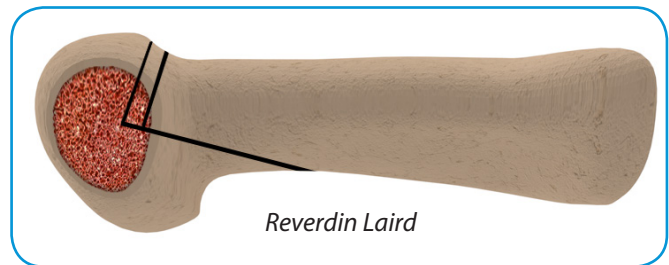
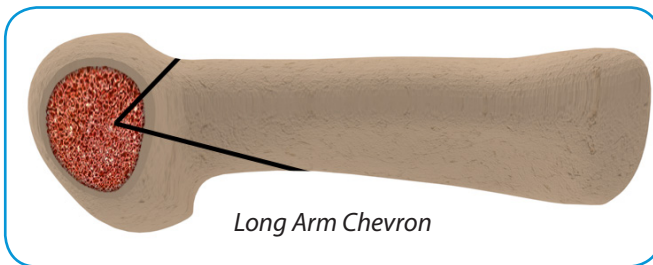

3. Pin the Landmark® Positioning Guide to the metatarsal, proximal to the osteotomy cuts. Drill the pin to stabilize the Landmark® Positioning Guide against the metatarsal.

Using the AO 1.4 mm, only drill the two Landmark® Positioning Guide bushings.

*Note: When performing angular correction osteotomies, the medial surface should be made planar prior to drilling the tine holes.*

*When drilling for the tines, drill to the laser marking depth line on the AO drill. When drilling the apex hole, drill through the medial surface. Tine hole depth is 15mm when the groove is at the top of the Landmark® Positioning Guide bushing.*

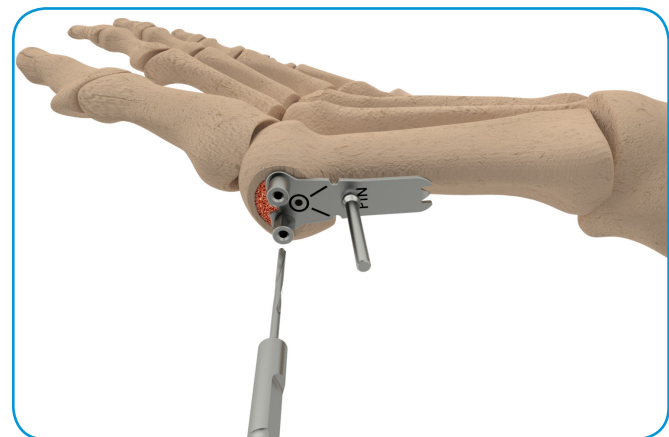

4. To place Re+Line® Bunion Correction Plate, refer to steps 9-12 in Chevron technique.

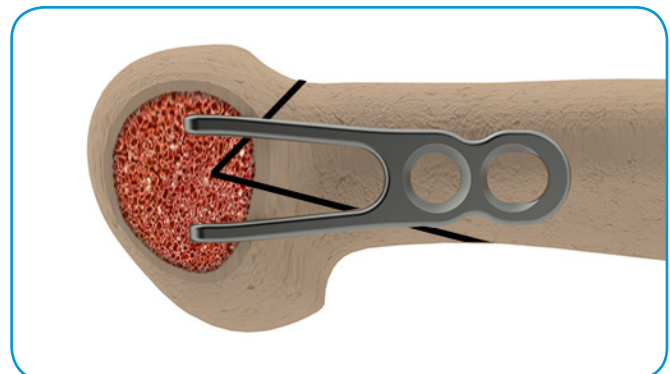

# Re+Line®

Bunion Correction System

## Re+Line® Bunion Correction System Sterile Procedure Kit

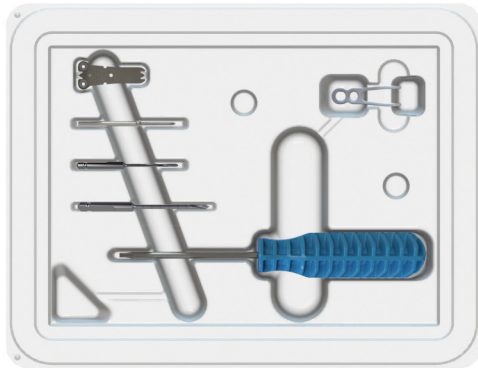

Re+Line® Screw (available separately in 6 sizes)



Re+Line® Bunion Correction Plate



T7 Driver



Landmark® Positioning Drill Guide 6.0mm

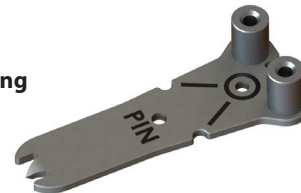

Temporary Pin



1.4mm AO Drill



2.0mm AO Drill



### ORDERING INFORMATION

Part No.	Description
RS-15610K	<b>Re+Line® Bunion Correction System Sterile Procedure Kit</b> Re+Line® Bunion Correction Plate (15mm x 6mm compression plate, two screw), Landmark® Positioning Drill Guide 6mm, 1.4mm / 2mm AO Drill, Temporary Pin, Driver
RS-20615K	<b>Re+Line® Bunion Correction System Sterile Procedure Kit</b> Re+Line® Bunion Correction Plate (20mm x 6mm compression plate, two screw), Landmark® Positioning Drill Guide 6mm, 1.4mm / 2mm AO Drill, Temporary Pin, Driver
RS-25815K	<b>Re+Line® Bunion Correction System Sterile Procedure Kit</b> Re+Line® Bunion Correction Plate (25mm x 8mm compression plate, two screw), Landmark® Positioning Drill Guide 8mm, 1.4mm / 2mm AO Drill, Temporary Pin, Driver
RS-2710	<b>Re+Line® 2.7mm x 10mm Compression Screw</b>
RS-2712	<b>Re+Line® 2.7mm x 12mm Compression Screw</b>
RS-2714	<b>Re+Line® 2.7mm x 14mm Compression Screw</b>
RS-2716	<b>Re+Line® 2.7mm x 16mm Compression Screw</b>
RS-2718	<b>Re+Line® 2.7mm x 18mm Compression Screw</b>
RS-2720	<b>Re+Line® 2.7mm x 20mm Compression Screw</b>
RS-DR	<b>Re+Line® T7 Driver Sterile</b>

This material is intended for health care professionals. Distribution to any other recipient is prohibited. For product information, including indications, contraindications, warnings, precautions, potential adverse effects and patient counseling information, see the package insert. Check for country product clearances and reference product-specific instructions for use.

This technique was developed in conjunction with health care professionals. This document is intended for surgeons and is not intended for laypersons. Each surgeon should exercise his or her own independent judgment in the diagnosis and treatment of an individual patient, and this information does not purport to replace the comprehensive training surgeons have received. As with all surgical procedures, the technique used in each case will depend on the surgeon's medical judgment as the best treatment for each patient. Results will vary based on health, weight, activity and other variables. Not all patients are candidates for this product and/or procedure. Caution: Federal (USA) law restricts this device to sale by or on the order of a surgeon. Rx only.

Nextremity Solutions, Re+Line and Landmark are trademarks of Nextremity Solutions, Inc. Zimmer Biomet is the exclusive distributor of the Re+Line® Bunion Correction System.

The Re+Line Bunion Correction System is manufactured using 316L Stainless Steel.

©2018 Nextremity Solutions LIT-1495 Rev.11



Distributed by:

Zimmer, Inc.  
1800 West Center St.  
Warsaw, IN 46580 U.S.A.  
(800) 613-6131  
[contactus@zimmerbiomet.com](mailto:contactus@zimmerbiomet.com)



Legal Manufacturer:

Nextremity Solutions, Inc.  
210 N. Buffalo St.  
Warsaw, IN 46580 U.S.A.  
(732) 383-7901  
[nextremitysolutions.com](http://nextremitysolutions.com)