

Nextra® CH Cannulated Hammertoe System

Surgical Technique

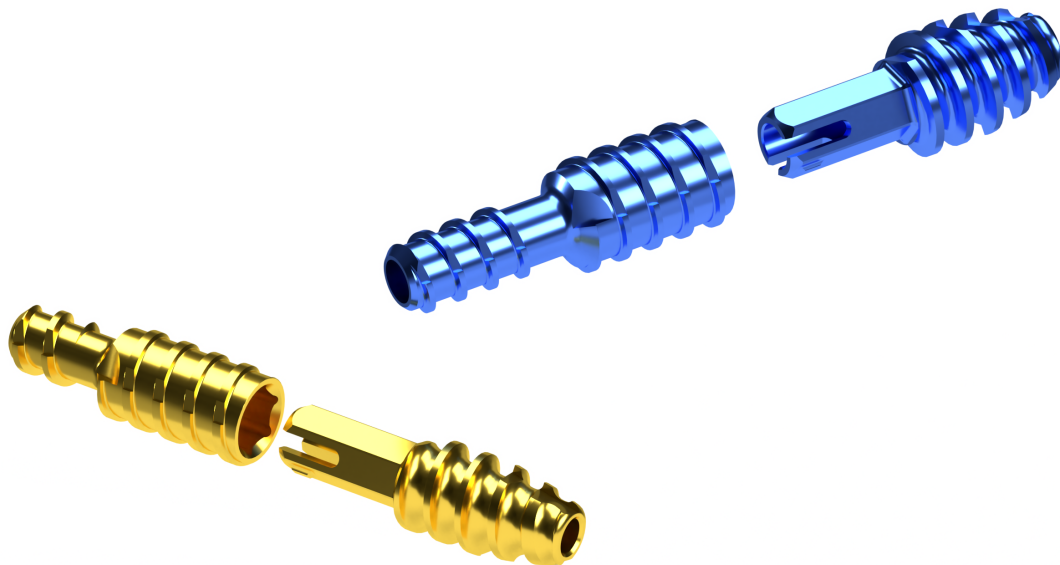

Nextra CH

Cannulated Hammertoe System

INTENDED USE/INDICATIONS:

The Nextra[®] CH Cannulated Hammertoe System is indicated for small bone reconstruction limited to interphalangeal repair and fusion of the lesser toes.

CONTRAINDICATIONS:

- The Nextra[®] CH Cannulated Hammertoe System is NOT intended for use in procedures involving the great toe. In addition, the device is contraindicated in the following:
 - Patient conditions including insufficient quantity or quality of bone.
 - Blood supply limitations and previous or active infections that may inhibit healing.
 - Surgical procedures other than for the indications listed.
 - Patients with conditions that limit their ability or willingness to follow postoperative care instructions.
 - The device may not be suitable for patients with insufficient or immature bone. The physician should carefully assess bone quality before performing orthopedic surgery on patients who are skeletally immature.
 - Where material sensitivity is suspected, appropriate testing should be performed, and sensitivity ruled out prior to implantation.

Nextra CH

Cannulated Hammertoe System

- Two-piece threaded implant construct designed for optimum bone purchase
- Cannulated implants and instruments provide targeting and technique guidance for repeatable procedures
- Implant-to-implant rotational stability via innovative hexagonal locking design
- Variable implant locking position provides in-situ adjustability before final closure
- Allows for optional technique to pin MPJ
- Single-use sterile packed kit

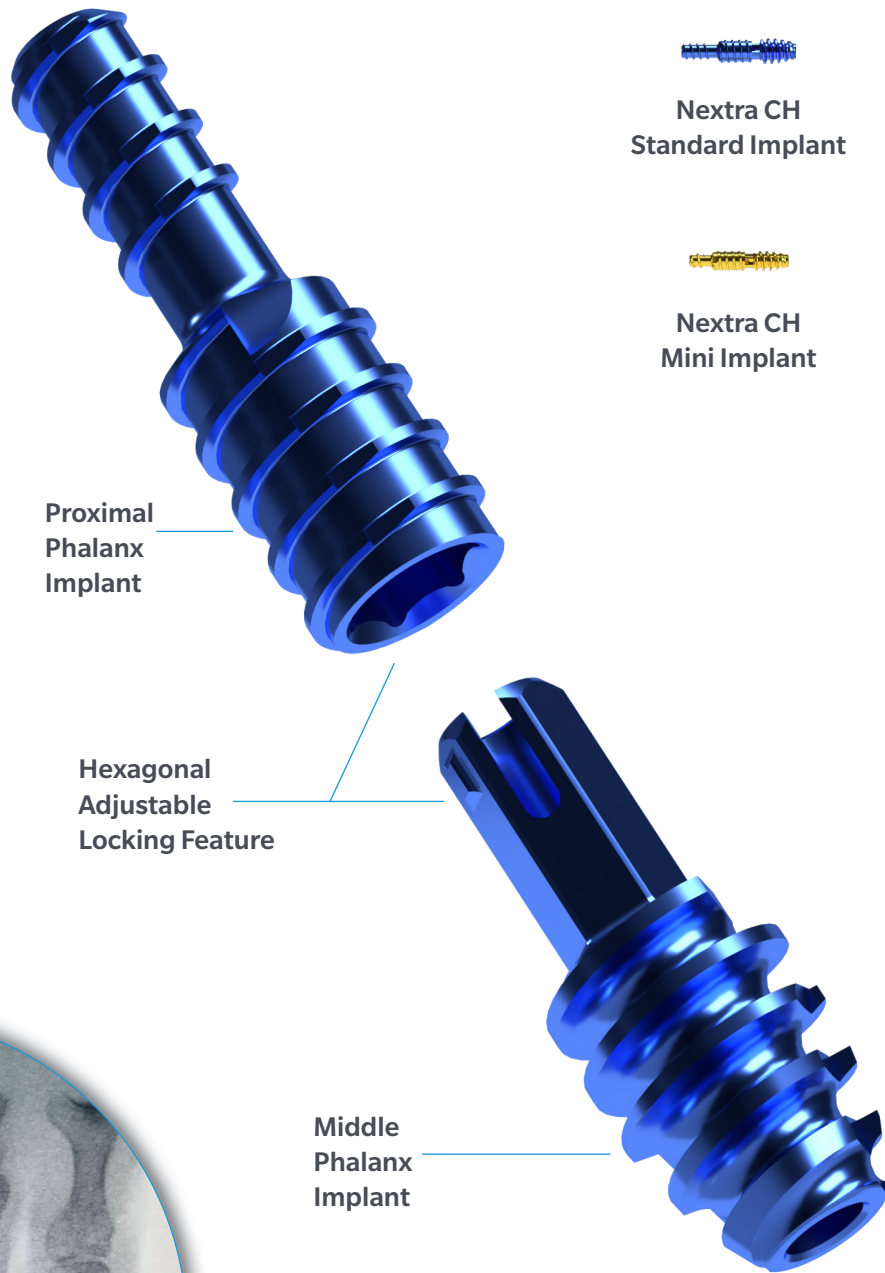

Post-Op X-ray

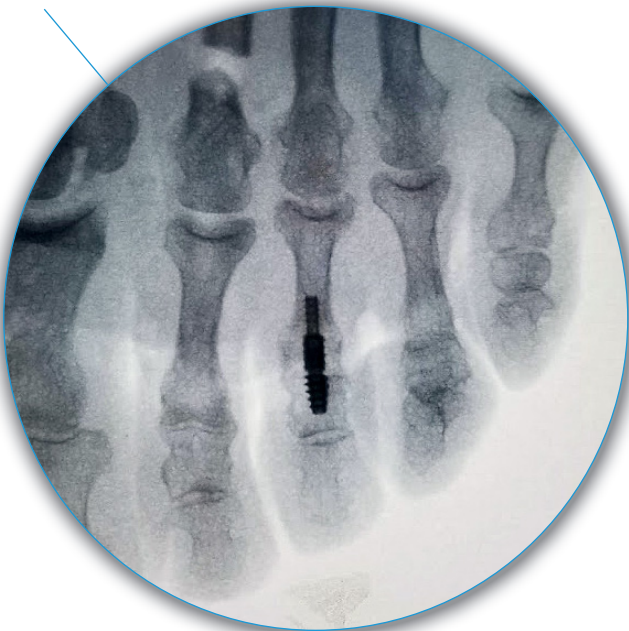

Implant made of Ti-6Al-4V ELI

Standard Implant (Blue)

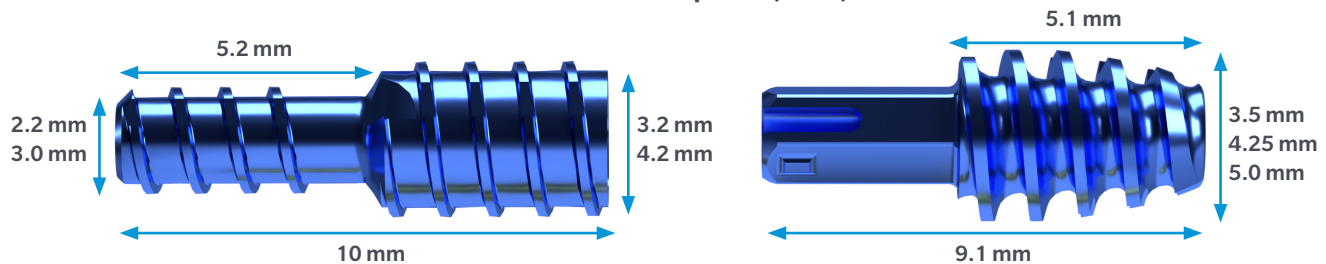

Mini Implant (Gold)

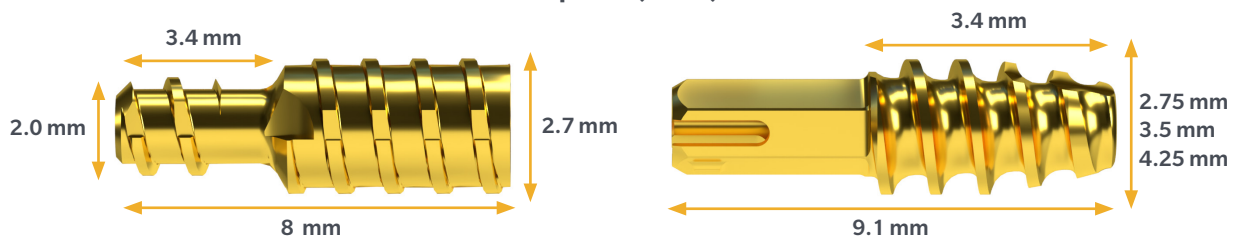

Nextra CH Sterile Instrument Kit

- Single patient use instrument tray
- Designed for precise, repeatable procedures
- Optimized for OR efficiency

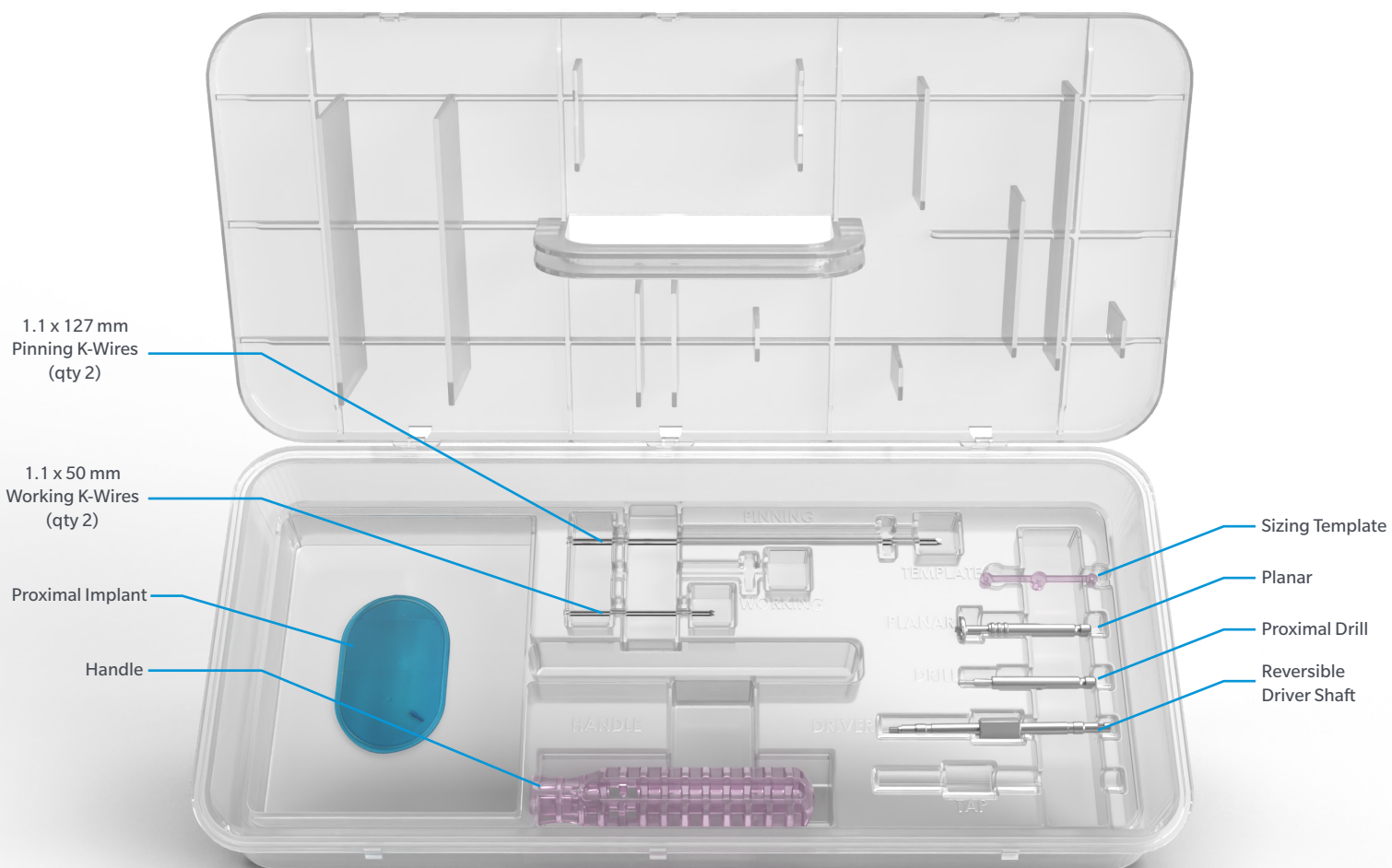

Surgical Technique

The following surgical technique describes the steps necessary to perform hammertoe surgery using the Nextra CH Cannulated Hammertoe System. This system includes both Standard and Mini implants. Please follow the outlined steps for both sized implants. Differences in procedures for Standard or Mini are noted.

1. Preparation – PIP Joint Exposure

Prepare the insertion site using standard surgical techniques. A typical approach involves a 2 cm dorsolateral incision over the target joint. Access to the bone is gained via a transverse capsulotomy with release of the collateral ligaments from the head of the proximal phalanx. Release tendon to allow for joint exposure.

2. K-Wire Placement – Proximal Phalanx

Based on pre-operative implant sizing determine the appropriate **Working K-Wire** (Standard 1.1 mm or Mini 0.9 mm). Align the **Working K-Wire** to the center of the proximal phalanx head along the IM canal.

NOTE: K-Wire placement can be checked using fluoroscope.

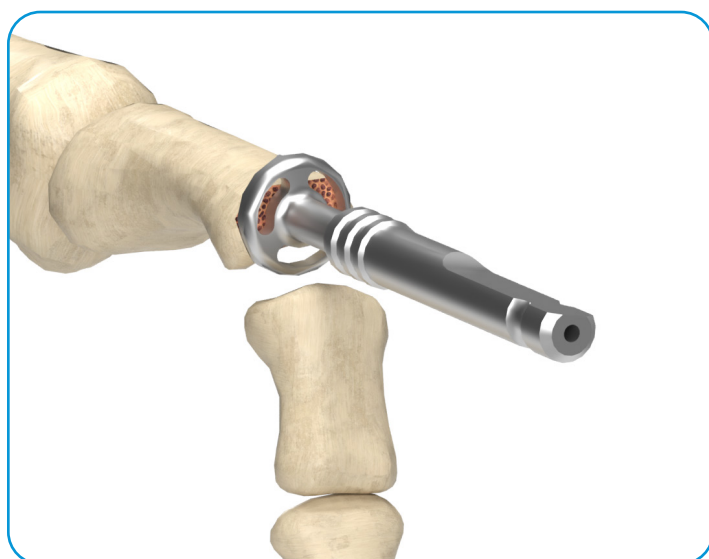
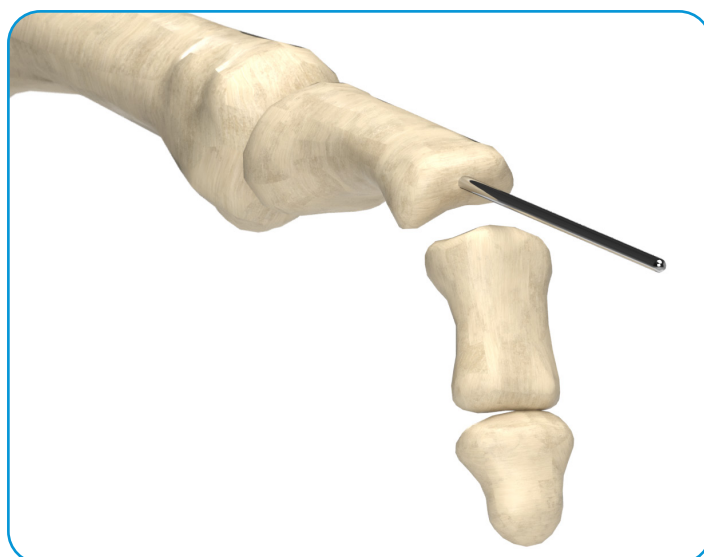

3. Resection – Planning Proximal Phalanx

Insert the 9 mm **Planar** over the **Working K-Wire** and resect the desired amount of proximal phalanx.

NOTE: If the resected bone surface created by the **Planar** did not cover the entire bone face, a curette or rongeur can complete the resection to ensure a flat surface is achieved.

4. Proximal Phalanx Pilot Drilling

Insert the **Proximal Drill** over the **Working K-Wire** and drill the bone until the cutting flutes are no longer visible. For *soft bone*, drill only until the first step is no longer visible. For *hard bone*, drill until hard stop.

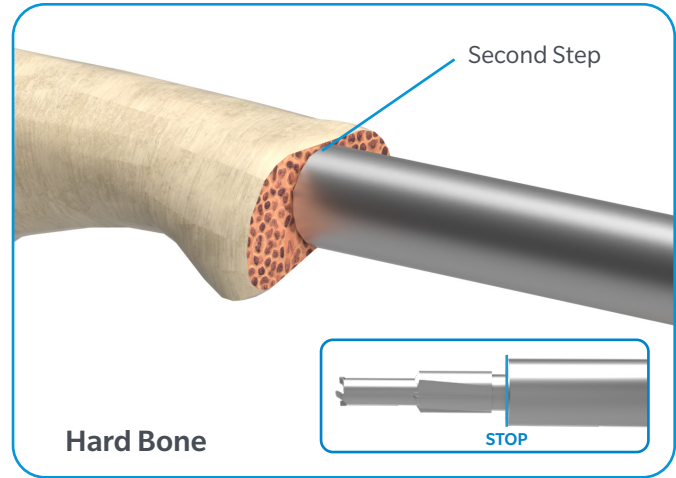
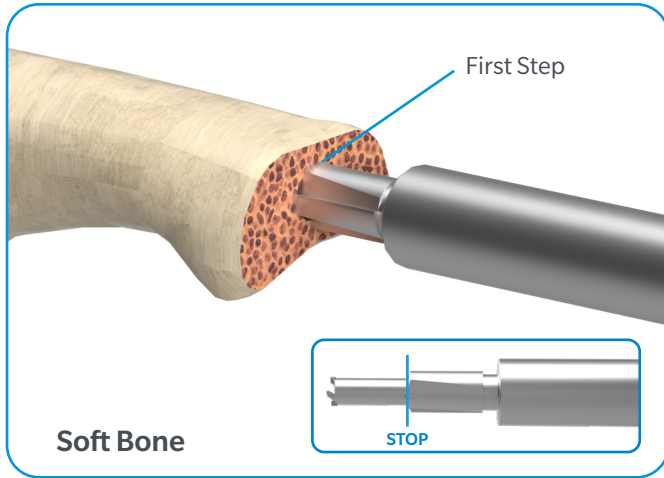

5. Proximal Implant Insertion

Assemble the desired size **Proximal Implant** onto the **Driver Shaft** end labeled "1 PROX". Insert the construct over the **Working K-Wire**. Thread the **Proximal Implant** into the proximal phalanx bone by turning the driver clockwise until the end of the proximal implant is flush or slightly countersunk with the cut surface. The final position of the **Driver Handle** should have one of the six flat sides oriented horizontally at the 12 o'clock position.

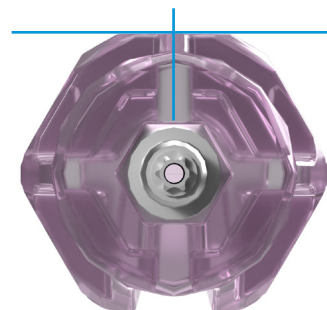
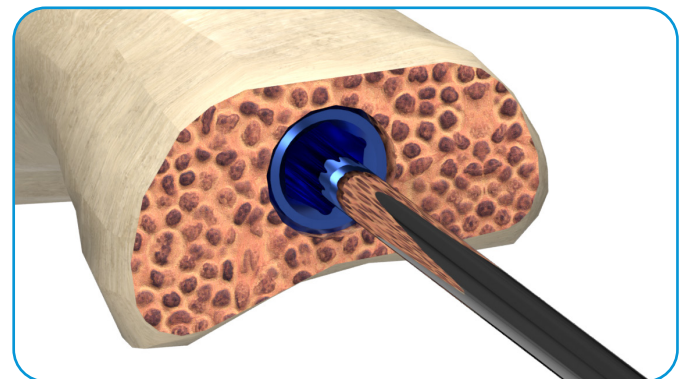
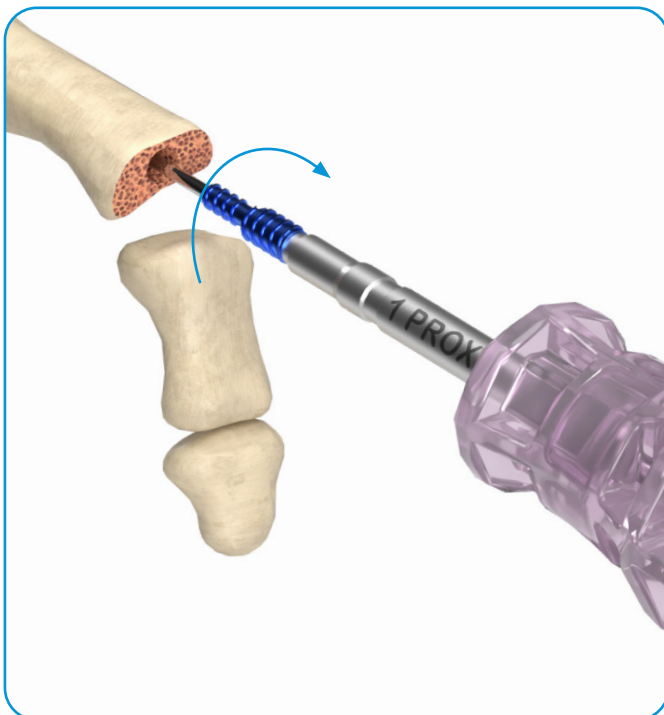

Surgical Technique

6. K-Wire Transition

Once the **Proximal Implant** has been inserted, the **Working K-Wire** will need to be removed from the proximal phalanx in preparation for the middle phalanx implant insertion. Either the existing or new **Working K-Wire** should now be inserted into the center of the middle phalanx.

NOTE: K-Wire placement can be checked using fluoroscope.

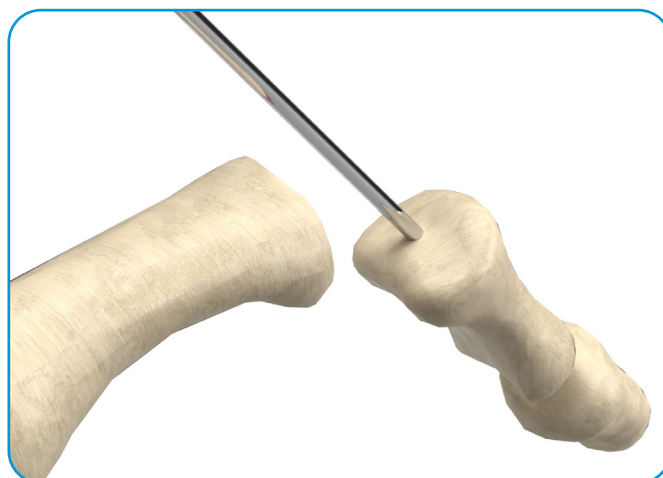
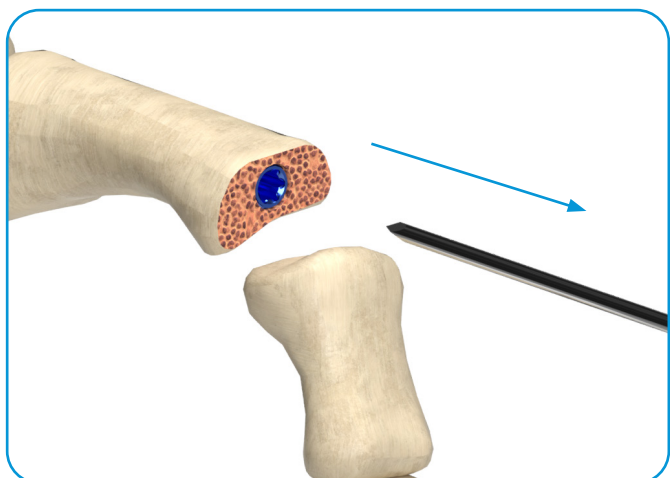

OPTIONAL: Temporary Stabilization with K-Wire Method

NOTE: This technique only applies to the standard size implants (1.1 mm cannula).

Place the **Pinning K-Wire** (1.1 mm X 127 mm) into the center of the middle phalanx, driving it through the distal phalanx until 4-5 mm remain exposed.

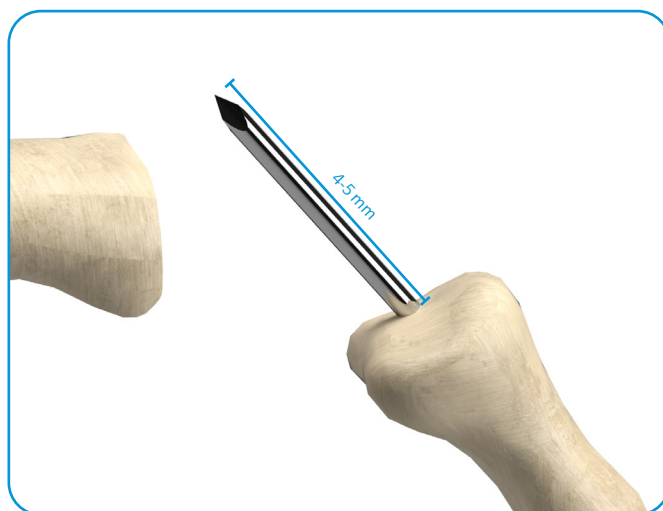
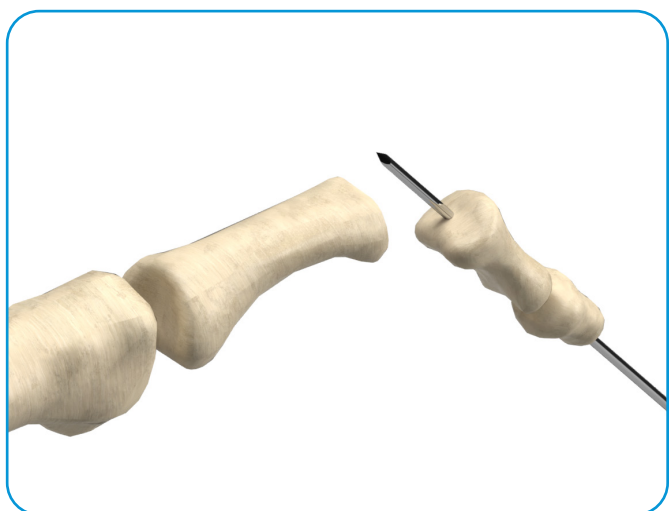

7. Resection – Planning Middle Phalanx

Insert the 9 mm **Planar** over the **Working K-Wire** or the **Pinning K-Wire** if optional technique was used. Using the **Planar**, resect the desired amount of middle phalanx.

NOTE: If the resected bone surface created by the **Planar** did not cover the entire middle phalanx bone face, a curette or rongeur can finish the resection to ensure a flat surface is achieved.

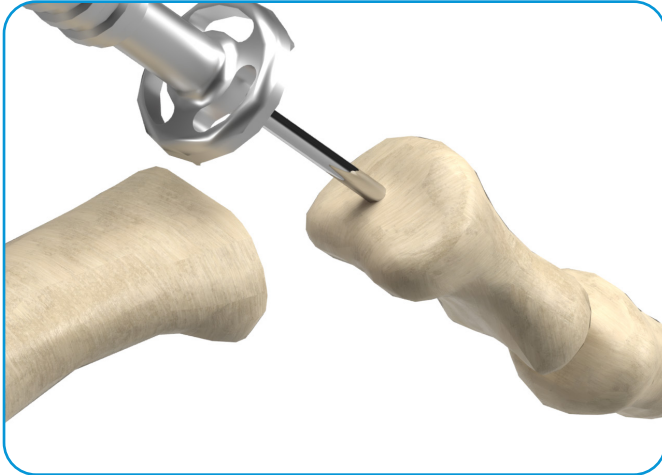

8. Middle Phalanx Sizing Template

Insert the **Sizing Template** over the **K-Wire** to determine the optimal **Middle Phalanx Implant** size. The outer diameter of the **Sizing Template** cylinders represent the outer diameter of the **Middle Phalanx Implant** threads.

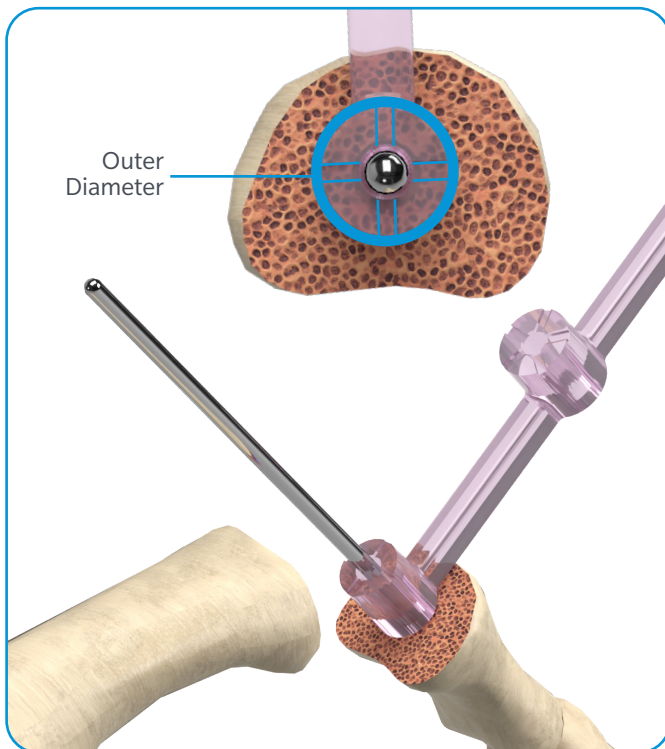

Standard sizing template shown with 4 notches, indicating a 4.25 mm Middle Phalanx Implant should be used.

Sizing Template Notch ID	Standard Middle Phalanx Implant
3	Middle 3.5 mm
4	Middle 4.25 mm
5	Middle 5.0 mm

Sizing Template Notch ID	Mini Middle Phalanx Implant
2	Mini Middle 2.75 mm
3	Mini Middle 3.5 mm
4	Mini Middle 4.25 mm

Surgical Technique

9. Middle Implant Insertion

Ensure that the tab of the implant is aligned with the laser etched line (Fig. 1) and visible in the window of the driver when fully seated. (Fig. 2) Assemble the desired **Middle Implant** onto the keyed **Driver Shaft** end labeled "2 MID". Insert the construct over the **K-Wire**. Thread the **Middle Implant** into the middle phalanx bone by turning the driver clockwise until the threads are buried or slightly countersunk in the cut surface. The final position of the **Driver Handle** should have one of the six flat sides oriented horizontally at the 12 o'clock position.

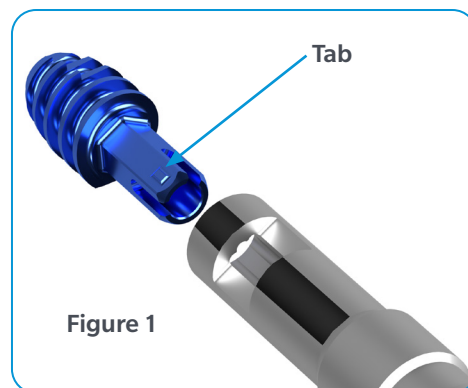

For difficult insertion or hard cancellous bone cases, the **Proximal Drill** may be used. Be sure to stop prior to the *second step* of the **Proximal Drill** or the DIP cortical wall, whichever occurs first.

NOTE: In the rare case where more implant purchase on the middle phalanx is desired, a larger middle phalanx implant should be used.

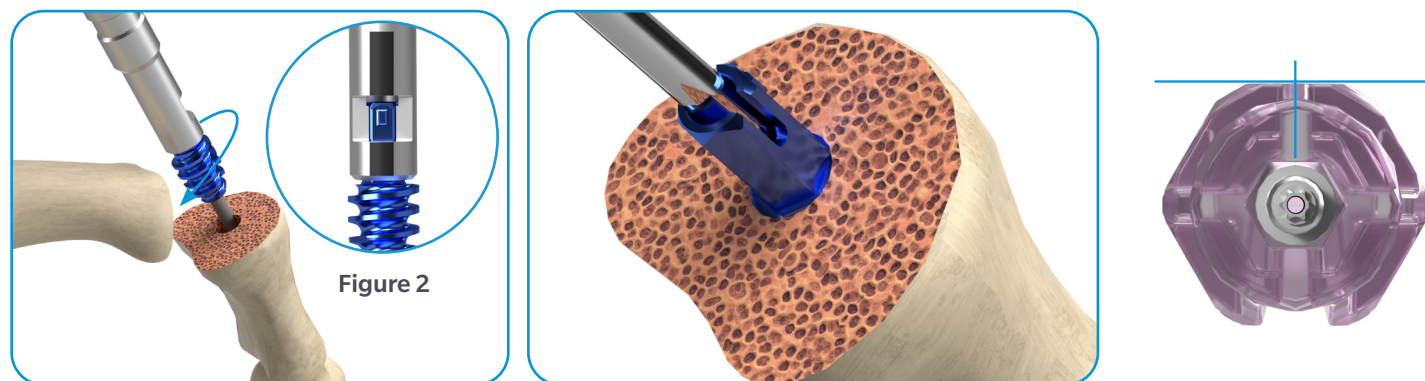

10. Removal of K-Wire

After the **Middle Implant** is in place, remove the **Working K-Wire** from the middle phalanx.

OPTIONAL: If the **Pinning K-Wire** optional technique was used, retract the **K-Wire** distally until just the tip of the **K-Wire** is visible or slightly inside the **Middle Implant** to prepare for final reduction.

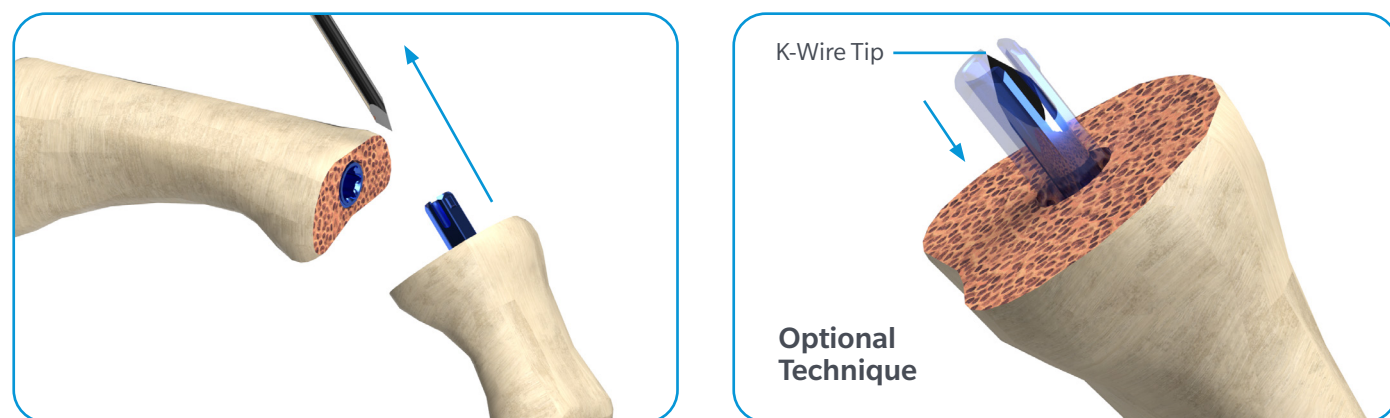

11. Alignment & Reduction

Align the stem of the **Middle Implant** axially with the **Proximal Implant** (Figure 1).

Reduce the proximal phalanx and middle phalanx by compressing the implants (Figure 2).

Seat the implants to achieve bone-to-bone contact for final apposition (Figure 3).

Close the wound in the conventional manner.*

In-Situ Repositioning: In the case that the final reduction or implant position is not satisfactory, the implant construct can be disassembled for in-site adjustments.

OPTIONAL: If the **Pinning K-Wire** technique was used, additional joint stabilization can be achieved by driving the **Pinning K-Wire** in a retrograde manner under fluoroscope until the MTP joint adequately crossed. Trim and cap the remaining **Pinning K-Wire** in the conventional manner.

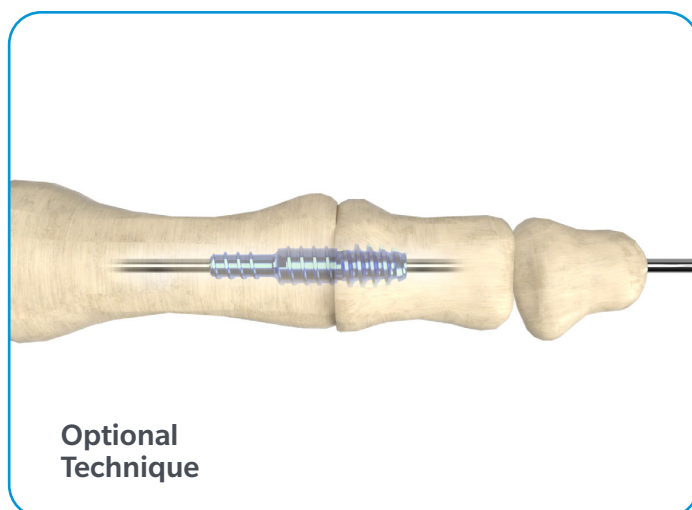
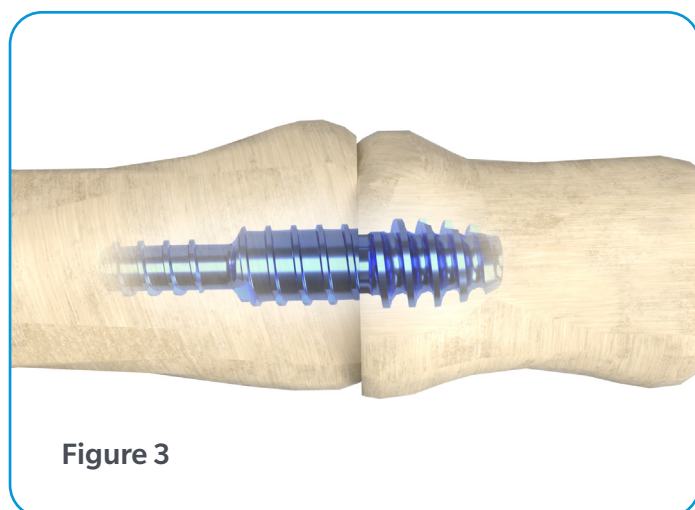
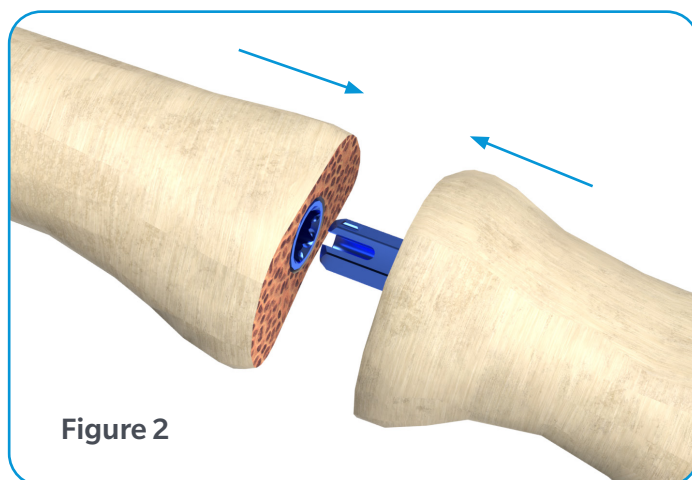
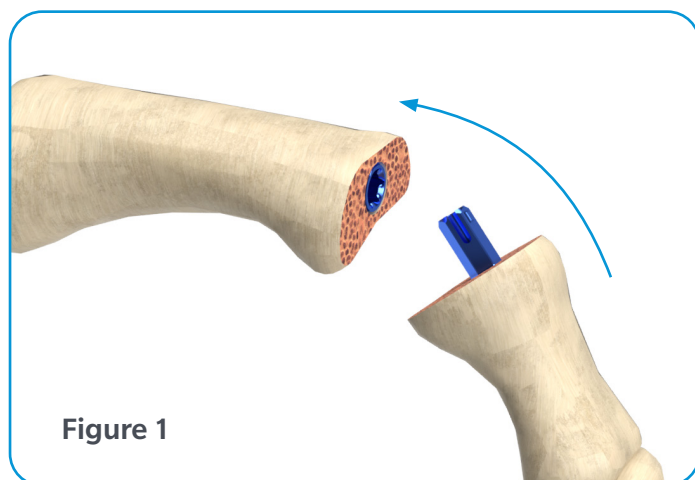

*Extensor tendon repair is recommended.

Revision Surgical Technique

The following surgical technique describes the steps necessary to perform revision surgery of the Nextra CH Cannulated Hammertoe System. The following steps can be applied to both Standard and Mini implants. Please follow the outlined steps for both sized implants.

Implant Removal Using Driver Handle

Make a dorsolateral incision over the joint to be revised. Clear any bone growth from around the implant construct that has filled the joint space. Using an osteotome or other surgical tool, distract the proximal and middle phalanges until the **Proximal Implant** and **Middle Implant** have disengaged (approximately 4 mm).

Insert the **Driver Shaft** into the **Driver Handle** with "1 PROX" displayed and insert into the **Proximal Implant**. Rotate counter-clockwise to remove the **Proximal Implant**. Remove the **Driver Shaft** from the **Driver Handle** and re-insert so "2 MID" is displayed. Insert the **Driver** into the **Middle Implant** and rotated counter-clockwise until the implant is fully removed.

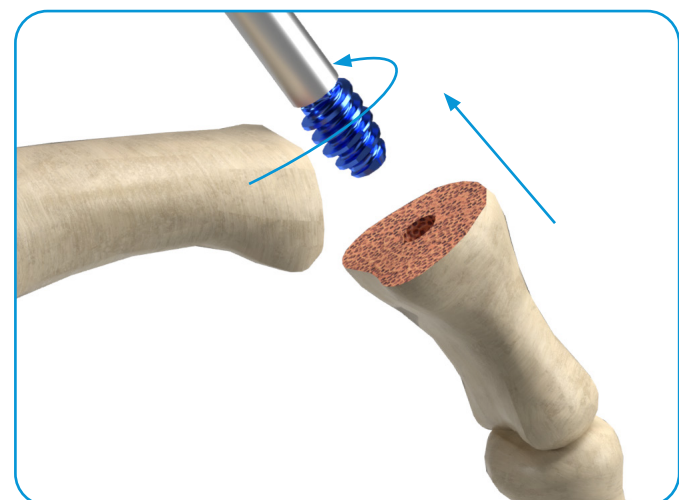
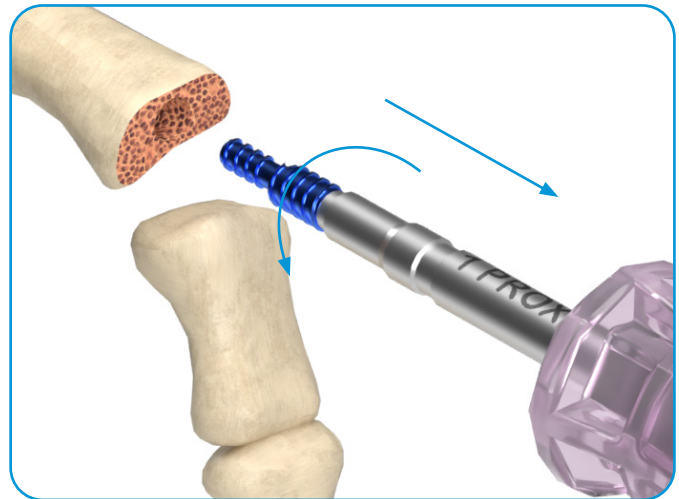
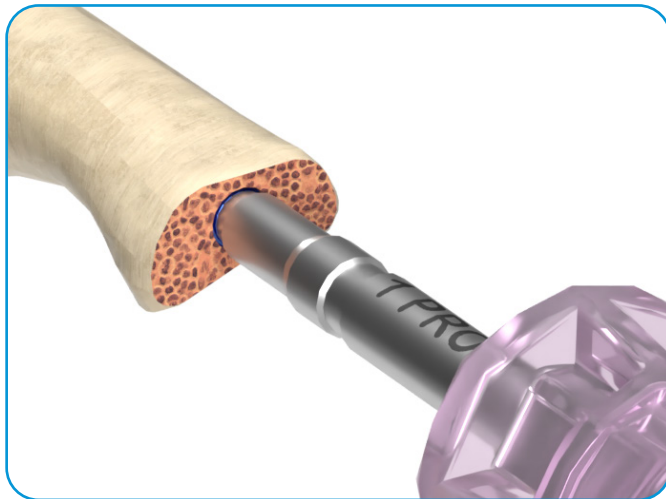

Implant Removal Using Retriever

In the rare case that the **Proximal Implant** cannot be unthreaded, the **Retriever** may be used. Insert the hooked end of the **Retriever** through the cannulation of the **Proximal Implant** (Figures 1 & 2) until the hook can grab the tip (Figure 3). Keep the laser line in the 12 o'clock position and apply upward force when pulling until the **Proximal Implant** is completely removed from the proximal phalanx (Figure 4).

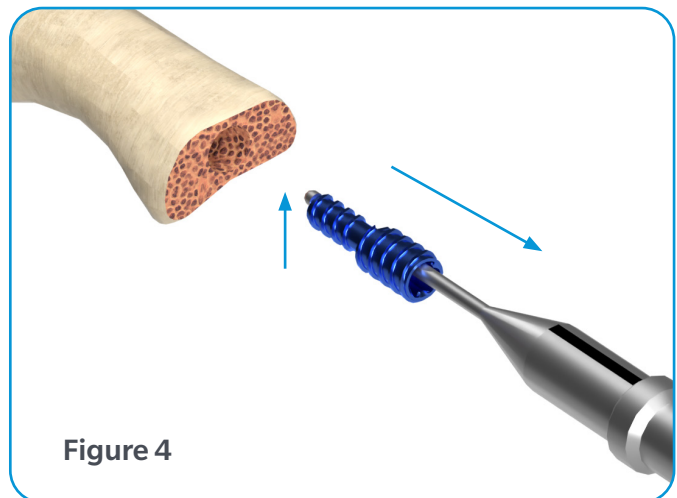
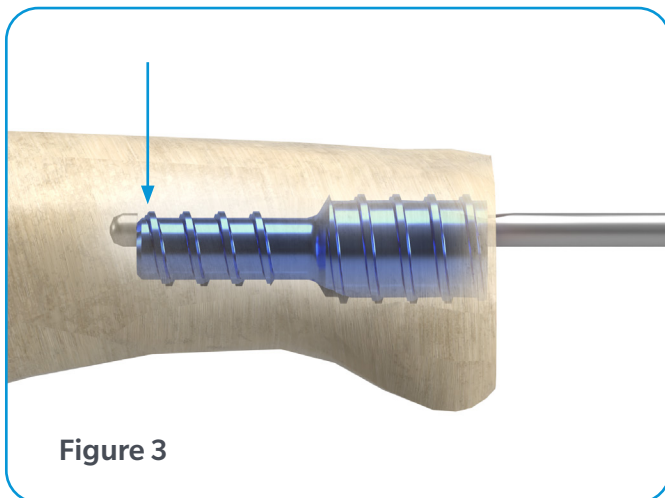
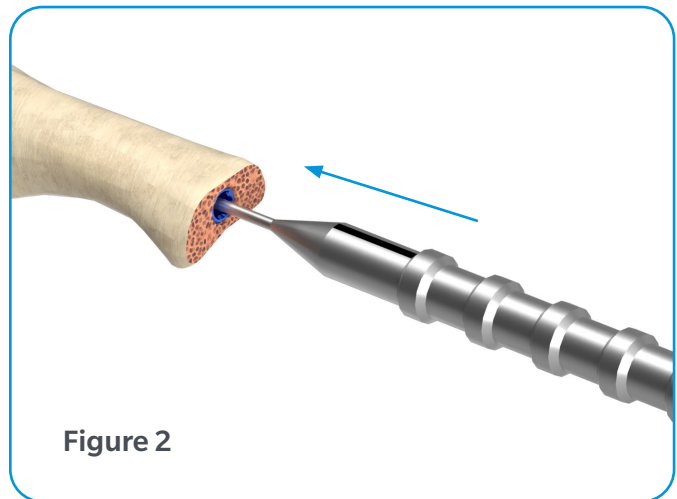
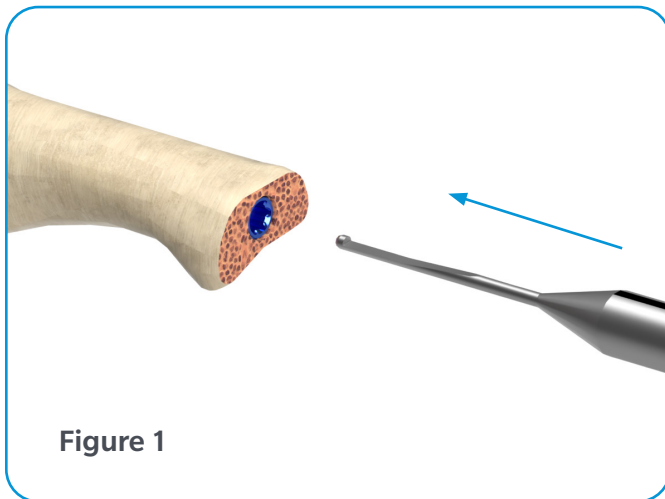

Ordering Information

Part No.	Description
KITS	
CH-275P-KT	NEXTRA CH Cannulated Hammertoe Proximal 2.75mm Instrument Kit w/ Implant
CH-32P-KT	NEXTRA CH Cannulated Hammertoe Proximal 3.2mm Instrument Kit w/ Implant
CH-42P-KT	NEXTRA CH Cannulated Hammertoe Proximal 4.2mm Instrument Kit w/ Implant
IMPLANTS	
CH-M275M	NEXTRA CH Mini Middle Cannulated Hammertoe Implant 2.75 mm
CH-M35M	NEXTRA CH Mini Middle Cannulated Hammertoe Implant 3.5 mm
CH-M425M	NEXTRA CH Mini Middle Cannulated Hammertoe Implant 4.25 mm
CH-35M	NEXTRA CH Standard Middle Cannulated Hammertoe Implant 3.5 mm
CH-425M	NEXTRA CH Standard Middle Cannulated Hammertoe Implant 4.25 mm
CH-50M	NEXTRA CH Standard Middle Cannulated Hammertoe Implant 5.0 mm
CH-M275P	NEXTRA CH Mini Proximal Cannulated Hammertoe Implant 2.75 mm
CH-32P	NEXTRA CH Standard Proximal Cannulated Hammertoe Implant 3.2 mm
CH-42P	NEXTRA CH Standard Proximal Cannulated Hammertoe Implant 4.2 mm
DISPOSABLES	
CH-RTR	NEXTRA CH Retriever
CH-DRIVERS	NEXTRA CH Driver Set

This material is intended for health care professionals. Distribution to any other recipient is prohibited. For product information, including indications, contraindications, warnings, precautions, potential adverse effects and patient counseling information, see the package insert, or contact your local Zimmer Biomet sales representative; for additional product information, visit www.zimmerbiomet.com.

Zimmer Biomet and Nextremity Solutions do not practice medicine. This technique was developed in conjunction with health care professionals. This document is intended for surgeons and is not intended for laypersons. Each surgeon should exercise his or her own independent judgment in the diagnosis and treatment of an individual patient, and this information does not purport to replace the comprehensive training surgeons have received. As with all surgical procedures, the technique used in each case will depend on the surgeon's medical judgment as the best treatment for each patient. Results will vary based on health, weight, activity and other variables. Not all patients are candidates for this product and/or procedure. Caution: Federal (USA) law restricts this device to sale by or on the order of a surgeon. Rx only.

Nextremity Solutions is a trademark of Nextremity Solutions, Inc. • Zimmer Biomet is the exclusive distributor of the Nextra® CH Cannulated Hammertoe System • The Nextra CH Cannulated Hammertoe System is manufactured using Ti-6Al-4V ELI.

©2023 Zimmer Biomet



3719.2-GLBL-en-Issue Date-2023-01
VV-08562

Legal Manufacturer
Nextremity Solutions, Inc.
210 N. Buffalo St.
Warsaw, IN 46580 U.S.A.
(732) 383-7901
nextremitysolutions.com

Zimmer Biomet, Inc.
1800 W. Center Street
Warsaw, IN 46580 USA
Tel: 1-800-348-2759
Fax: 574-372-3968
www.zimmerbiomet.com