

InCore™ Lapidus System Precision Guided Correction

Surgical Technique

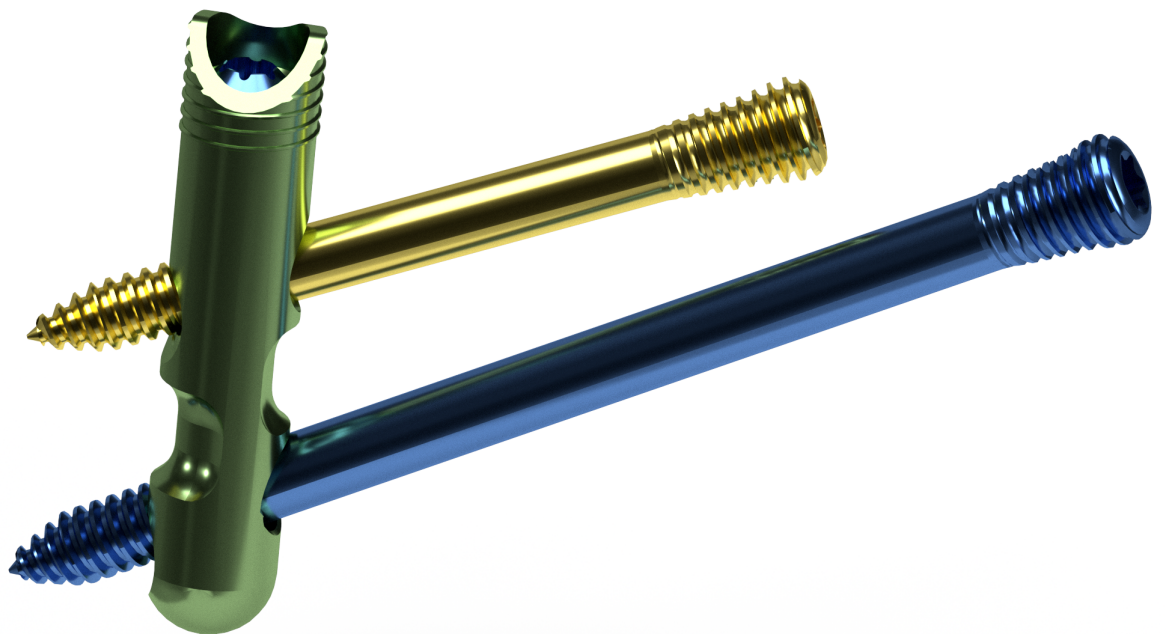

InCore Lapidus System Precision Guided Correction

• Tri-Planar Correction

- Targeting Guide is intended to aid and stabilize angular/rotational correction in all three planes (transverse, sagittal and frontal plane)

• Fully Guided

- Post and Targeting Guide utilize anatomical land marks to facilitate fixation placement
- Angular correction of the metatarsal facilitated and maintained by the targeting guide

• Solid Intermedullary Construct

- Solid 5.9mm Titanium Post provides large surface area engagement in the cancellous bone of the medial cuneiform
- Headless compression screws thread directly into the 5.9mm post
- Post and screws construct may reduce hardware prominence and resultant hardware removal due to pain or irritation related to such hardware prominence
 - Hardware removal due to pain and irritation is reported in up to 17% of first tarsometatarsal arthrodesis cases when using plating constructs^{1,2}

• Joint Preparation

- Targeting Guide provides distraction of the joint for visualization and joint preparation
- Distraction allows space for curettage and microfracture

• Controlled Compression

- Targeting Guide includes built-in Compression-Distraction Fixture providing compression parallel to the long axis of the first metatarsal

• Features

- 5.9mm x 28mm Titanium Post
- 3.5mm Diameter Headless Compression Screws offered from 24 to 56mm in length
- Robust T10 Hexalobe Driver

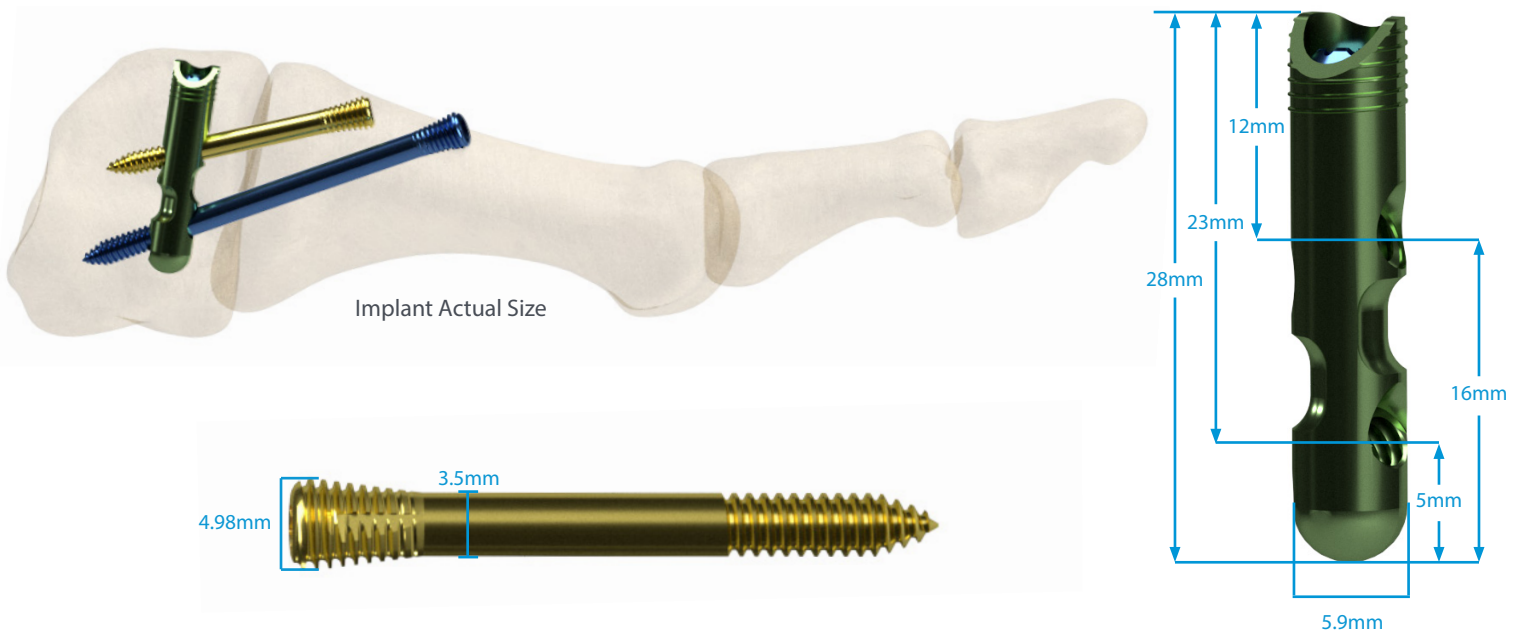

Surgical Technique

1. Prepare instrumentation by first ensuring the top line of the **Compression-Distraction Fixture** is aligned with the start line of the **Targeting Guide**. The **T10 Driver** is used to rotate the **Screw**, causing the **Compression-Distraction Fixture** to travel along the **Targeting Guide**. Improper alignment may restrict potential distraction and compression travel of the **Compression-Distraction Fixture**.

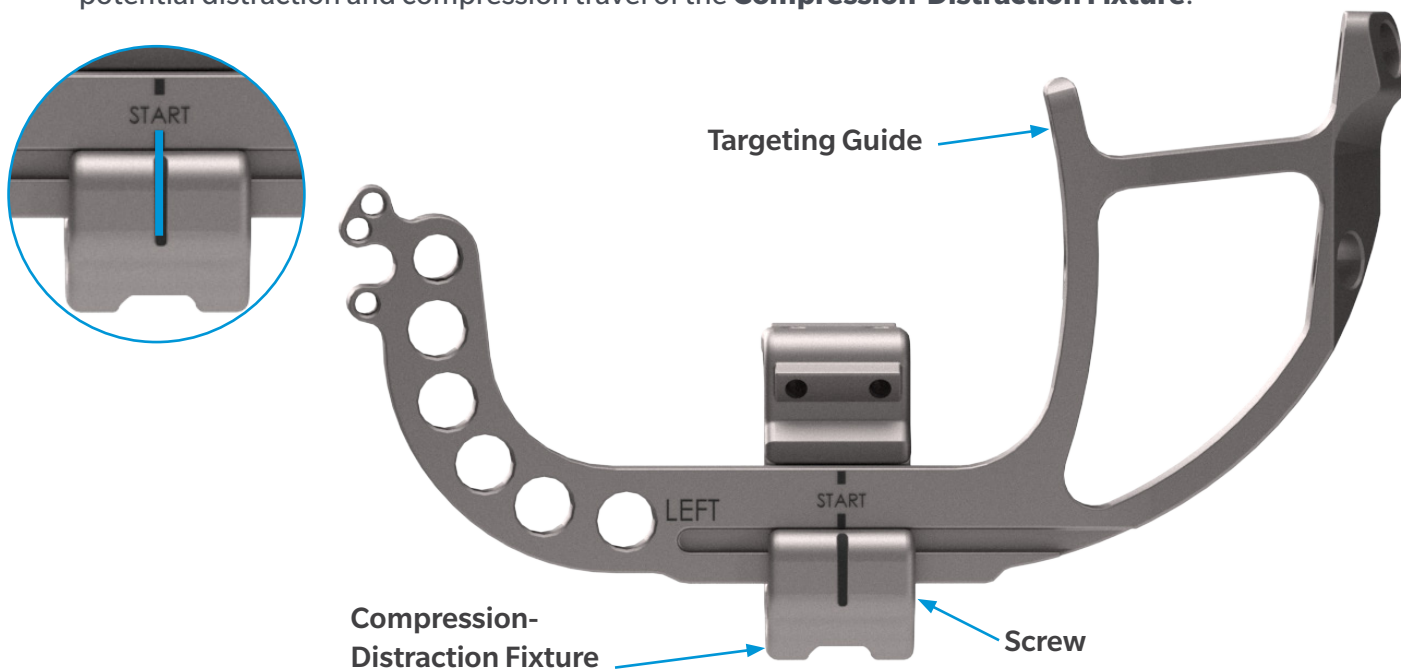

NOTE: The InCore Disposable Kit will come pre-assembled. After removing from package, confirm Compression-Distraction Fixture is positioned at "Start". Ensure Post Fastener is hand tightened and Target Guide holes align with Post holes.

2. Assemble the **InCore Post** to the **Targeting Guide**. Thread the **Post Fastener** into the implant **Post**, with the **Targeting Guide** positioned between. After firm hand tightening of the **Post Fastener**, there will be no gap or play between the components.



3. Sighting the holes in the **Targeting Guide**, alignment can be visualized to ensure proper assembly and left/right foot selection. The *medial hole* of the **Targeting Guide** aligns with the *plantar hole* in the **Post**. The *lateral hole* of the **Targeting Guide** aligns with the *dorsal hole* of the **Post**.

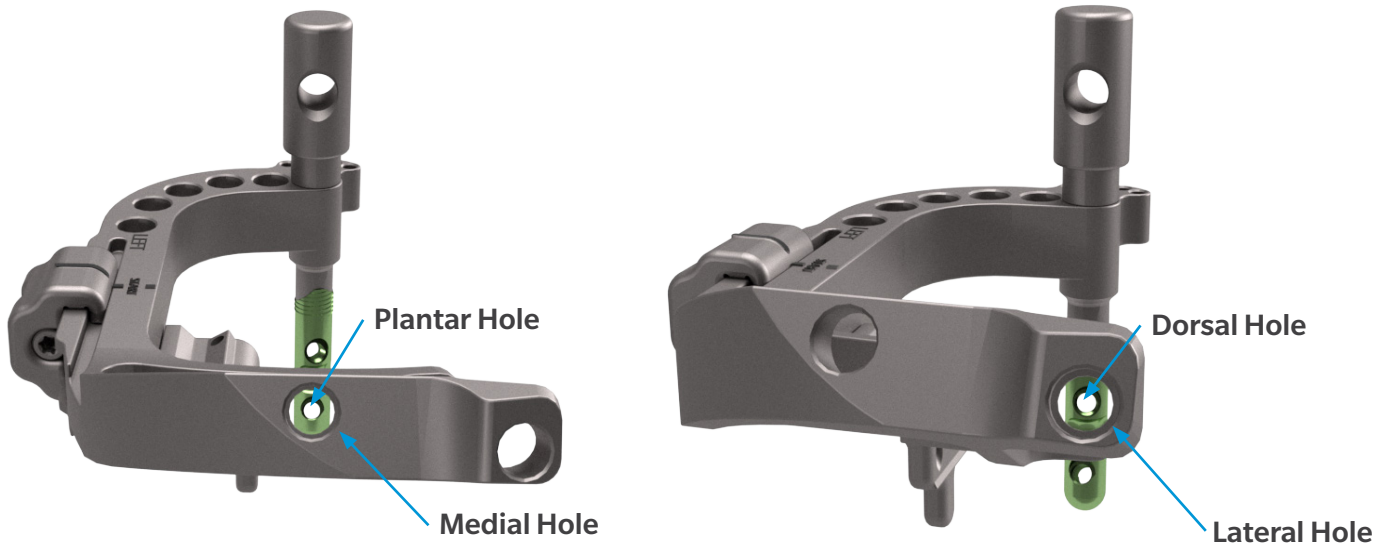

4. Make a dorsal incision over the tarsometatarsal joint.
5. Perform soft tissue releases to ensure full mobility of the first metatarsal to the desired correction position.
6. Position the **Post Drill Guide** so that the largest paddle is between the medial cuneiform and the first metatarsal and the smaller paddle is between the medial cuneiform and 2nd metatarsal.

NOTE: Minimal soft tissue release between the medial cuneiform and medial 2nd metatarsal base should be performed with care to avoid injuring the LisFranc ligament.

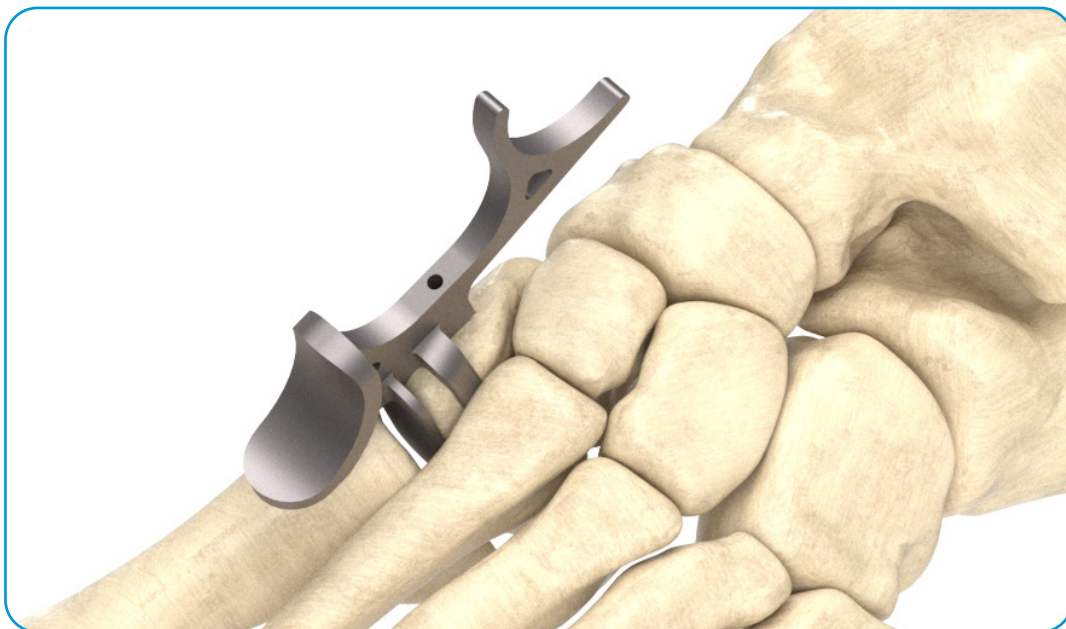

- 7.** Before placing a **2mm K-wire**, loosely place the **K-wire** into the **Post Drill Guide** and observe the angle of the **K-Wire** to be both parallel to TMT joint and in the middle of the long axis of the medial cuneiform. The **K-wire** will generally be placed dorsal-lateral to plantar medial. Adjust as necessary and place **K-wire** through the **Post Drill Guide** and into the bone.

NOTE: If planning to cut the cuneiform for bone preparation, you may consider making cut prior to placing **K-wire**.

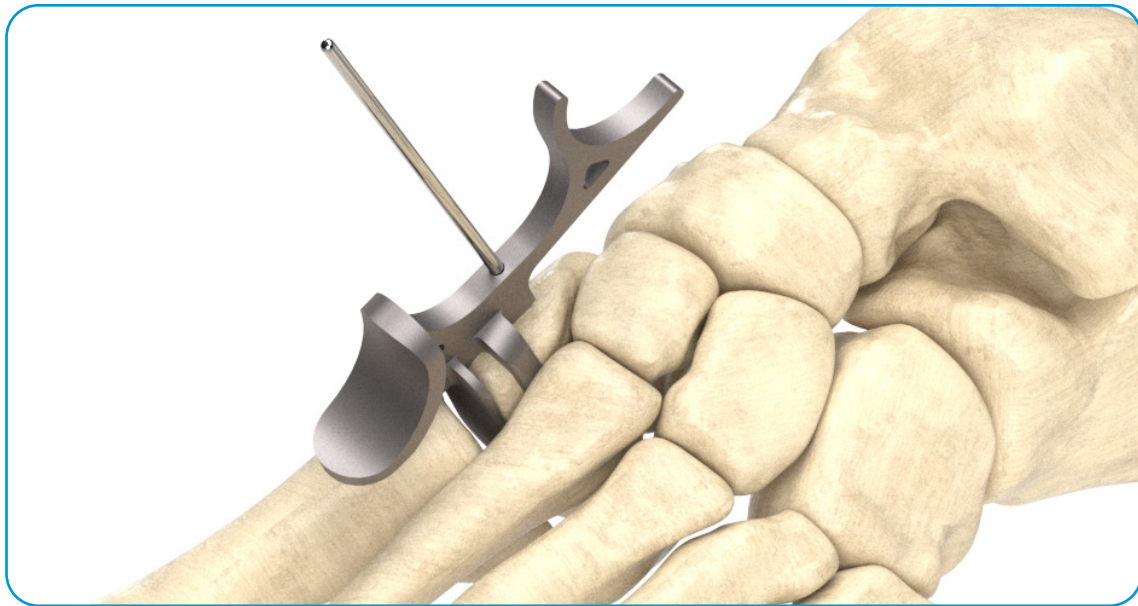

- 8.** Remove the **Post Drill Guide**, leaving the **2mm K-wire** in the bone.

NOTE: The guide is configured to aid in placing the K-wire through major axis of the cuneiform. The angle of the K-wire with respect to the medial aspect of the cuneiform as well as X-ray should be assessed to ensure the K-wire is surrounded by adequate bone for reaming. There must be at least 28mm of tunnel to ensure the post is appropriately seated in the bone. Adjust K-wire when necessary to account for variations in anatomy.

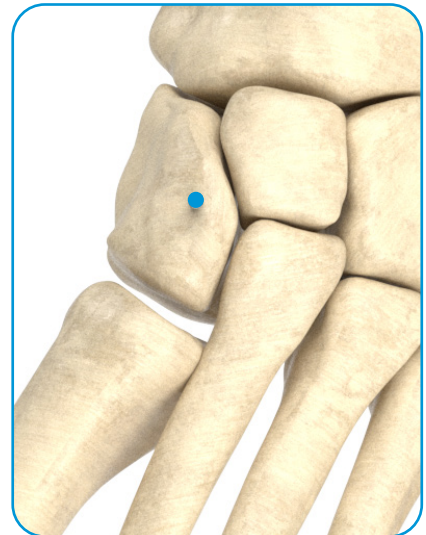
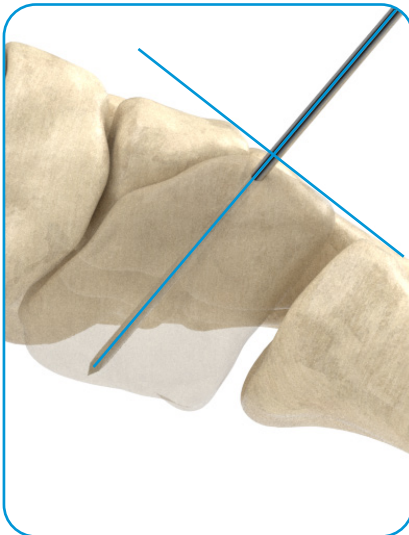
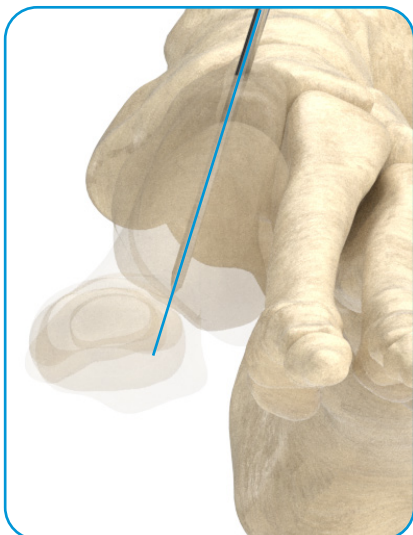

9. Insert the **5.9mm Post Reamer** over the **2mm K-wire** and drill until the depth line on the drill bit is at or just below bone surface.



10. Insert the **Post and Targeting Guide Assembly** into the previously reamed hole located in the medial cuneiform. Fully seat the **Post** into the bone ensuring the **Targeting Guide** depth lines are at or just below bone surface.

NOTE: Light malleting may be required to fully seat post.

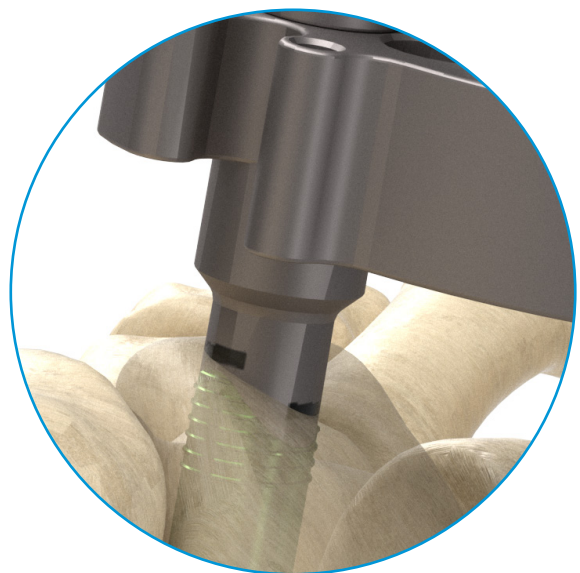
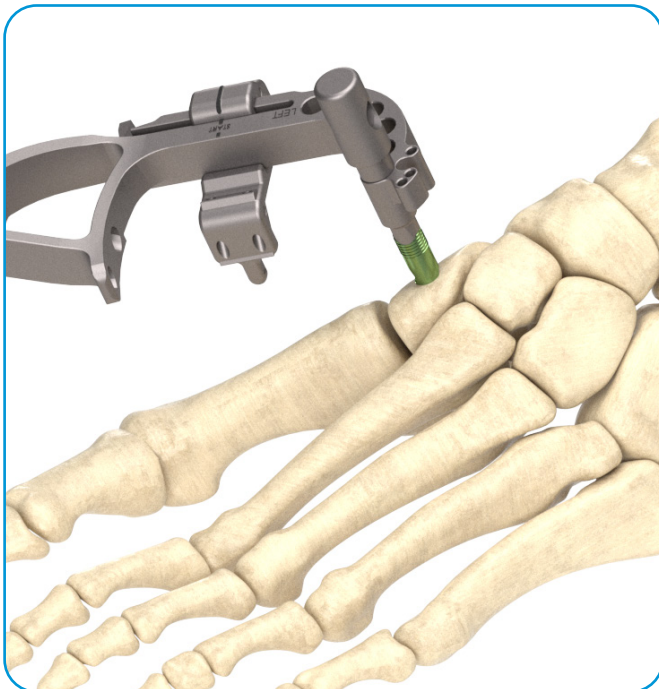

11. Manipulate the metatarsal to correct tri-planar deformity. It may be helpful to drive a K-Wire into the metatarsal to be used as a joystick to gain additional frontal plane correction.

With the **Compression-Distraction Fixture** against the metatarsal, evaluate the anticipated screw entry points on the metatarsal by placing the **Depth Measuring Probe** through the **Targeting Guide** holes. Proper depth of the **Post**, rotation of the **Targeting Guide** about the **Post**, and degree of bone removal during joint preparation are elements that can affect the entry point of screws in the metatarsal.

Once the metatarsal is rotated to desired location, place two **2mm K-wires** through the **Compression-Distraction Fixture** and into the metatarsal to stabilize correction.

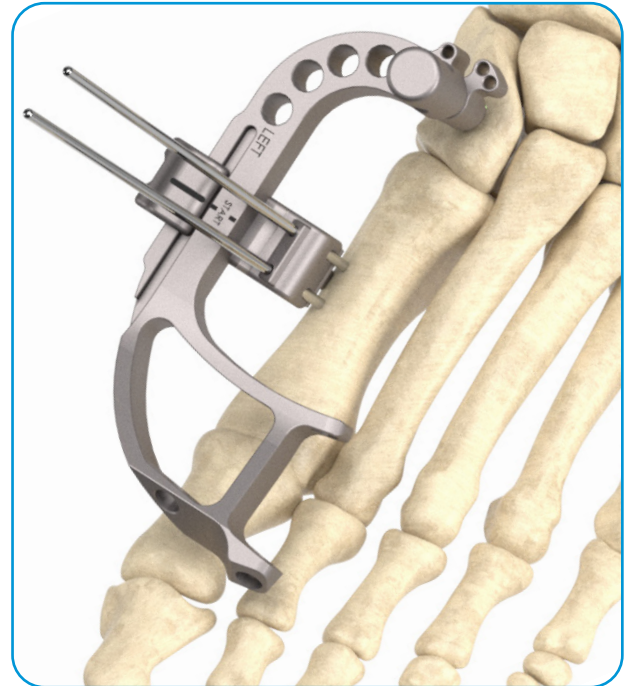

12. Manipulate the metatarsal to correct the IM angle. Correction can be maintained by inserting a **2mm K-wire** through the **Compression-Distraction Fixture** and into the cuneiform, proximal to the post. A large periarticular clamp* may also be useful to achieve and maintain correction distally as shown.

* Clamp not included

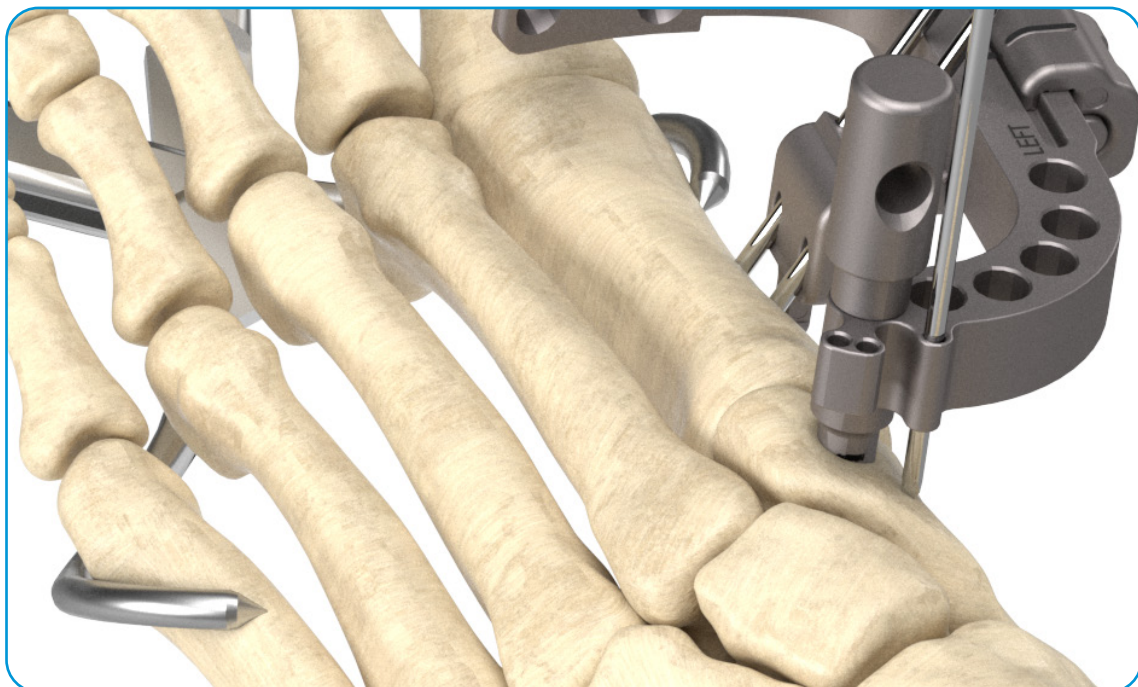

- Using the **T10 driver**, turn the **Screw** in the **Compression-Distraction Fixture** counter-clockwise to distract the 1st tarsometatarsal joint.

NOTE: Soft tissue release may be required to achieve desired distraction and optimal visualization.



- After desired distraction is achieved, continue to prep the joint with curettage, microfracture and other preferred bone preparation methods.
- Following bone preparation, turn the **Screw** clockwise to compress the metatarsal to the medial cuneiform. While compressing, ensure metatarsal base does not deflect plantarly and that the Post does not shift dorsally.

NOTE: The correction should be assessed clinically and with intraoperative fluoroscopy or radiographs to ensure the desired correction is achieved. If adjustment is necessary, remove compression, readjust the deformity correction and K-wires as needed before recompressing the joint.

NOTE: A K-wire can be placed horizontally through the distal aspect of the first and second metatarsals to maintain alignment.



- 16.** Once desired correction is achieved and secured in compression, place the **Drill Bushing** into the medial hole in the **Targeting Guide**. Ensure the **Drill Bushing** chosen is the longest bushing that will fully seat against the **Targeting Guide** without touching the metatarsal.

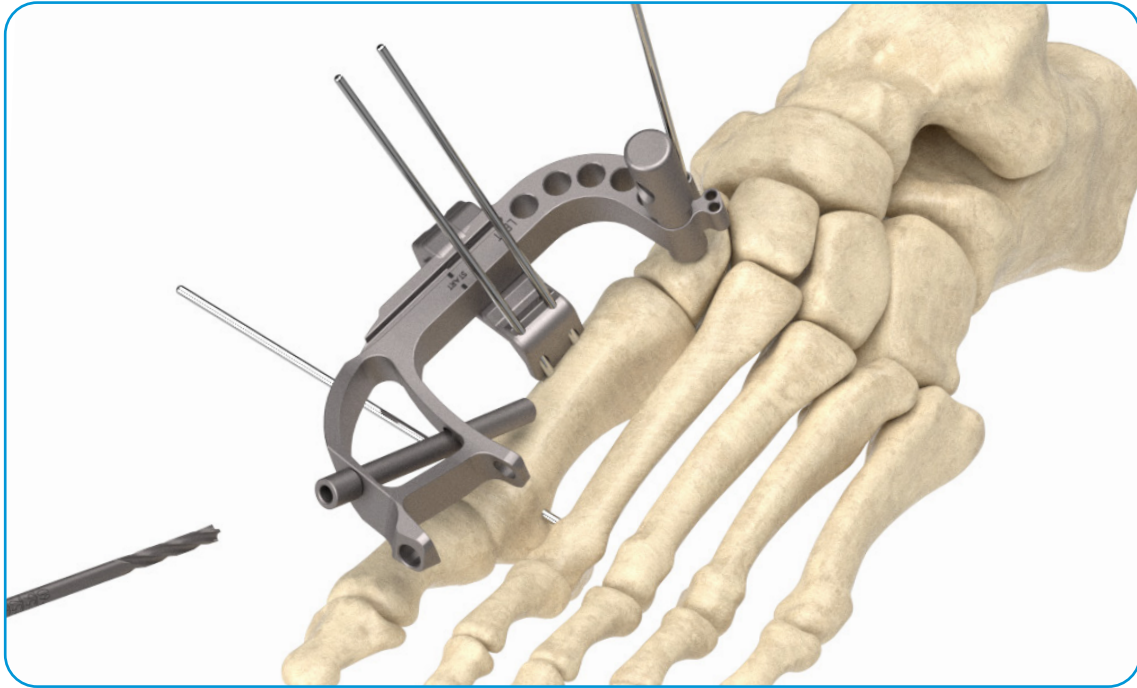

- 17.** Ensure the post is fully seated, then introduce the **3.6mm Drill Bit** into the **Drill Bushing**. **Do NOT begin drilling until the Drill Bit engages the bone.** Fully seat the **3.6mm Drill Bit** against the **Drill Bushing** (up to the step on the bit) to ensure drill creates a continuous tunnel of an appropriate length to the **Post**.



- 18.** Remove the **Drill Bushing** and place the **Depth Measuring Probe** through holes in **Targeting Guide** until the **Probe** makes firm contact to bone. It may be necessary to remove bone debris that could impede measurement. Then read the measurement at the guide surface which correlates with the suggested **3.5mm Screw** length. Based on measurement, select **3.5mm Screw**. If measurement is between sizes, consider a shorter screw option to ensure the screw is not too prominent.

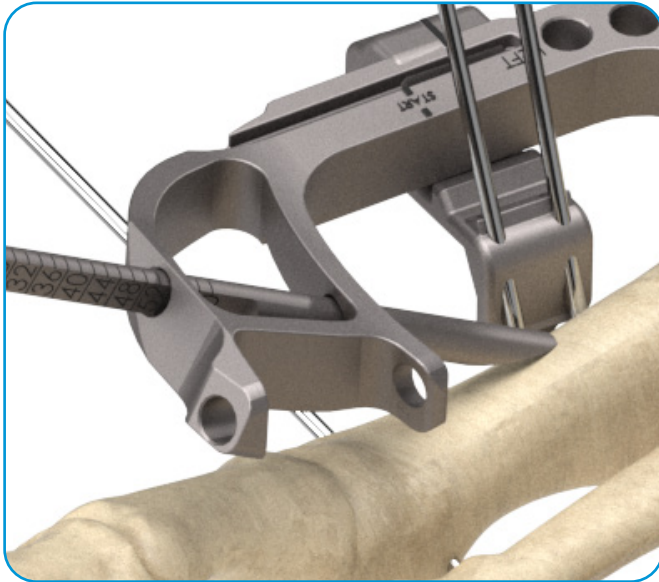

- 19.** Insert **3.5mm Screw** through pre-drilled tunnel until it reaches the **Post** or the rear screw head reaches the bone. Then rotationally advance until fully seated into the **Post**. Do NOT attempt to drive screw beyond hard stop. If screw head is too prominent or buried too deep, remove screw and select appropriate length.

NOTE: Care should be taken to ensure the 3.5mm Screw threads correctly into the Post without cross threading. Significant resistance prior to 10 full rotations is a sign of misalignment or cross threading.

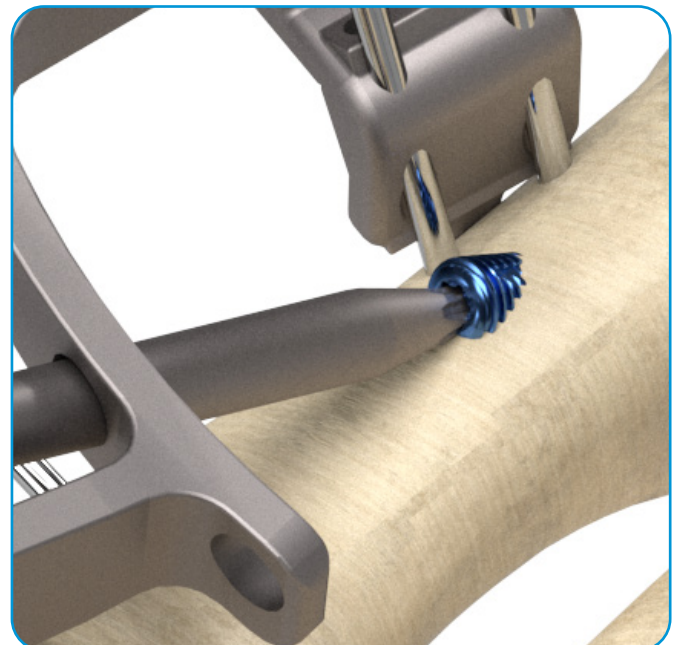
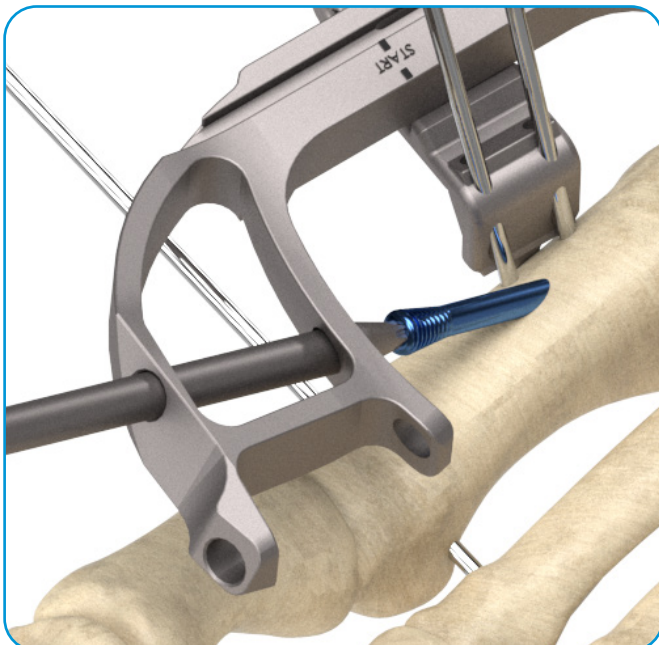

- 20.** Repeat the process of choosing the correct **Drill Bushing**, drilling, measuring for **3.5mm Screw** length and screw placement for the lateral screw.

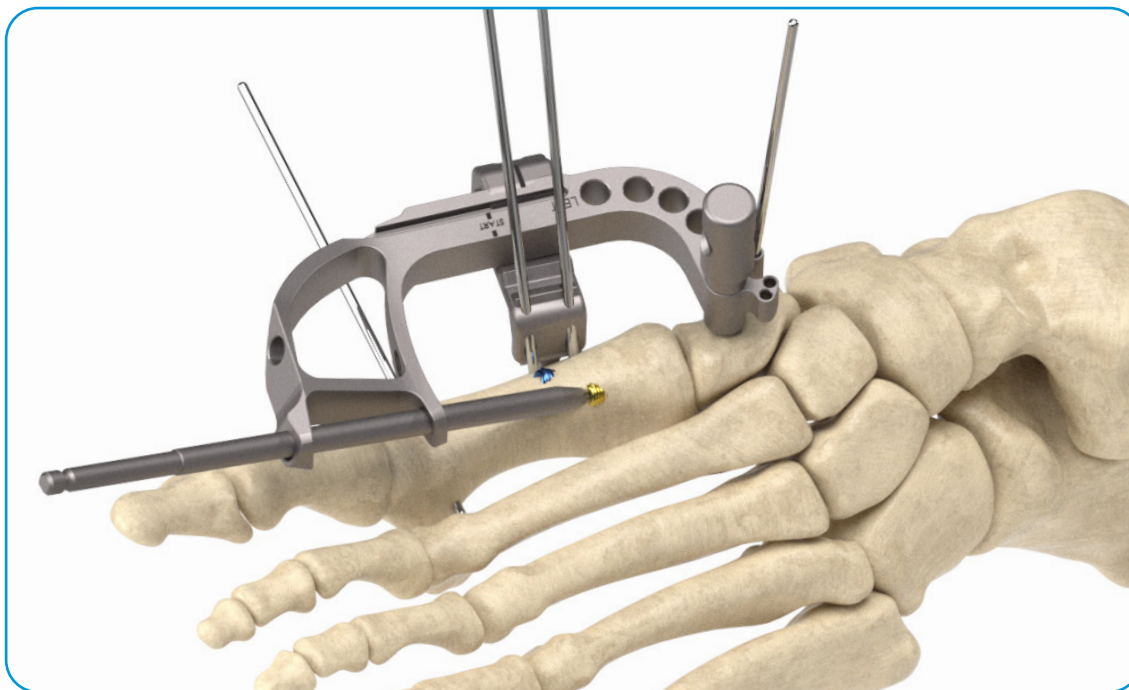

- 21.** To aid in removing **K-Wires**, slightly reduce the compression by turning **Compression-Distraction Fixture Screw** counter-clockwise and remove all **K-wires**. Twist **Post Fastener** to release from **Post** and remove **Targeting Guide**.

- 22.** Once both **3.5mm Screws** are locked into the **Post**, thread the **Post Plug Screw** into the top of the **Post**.

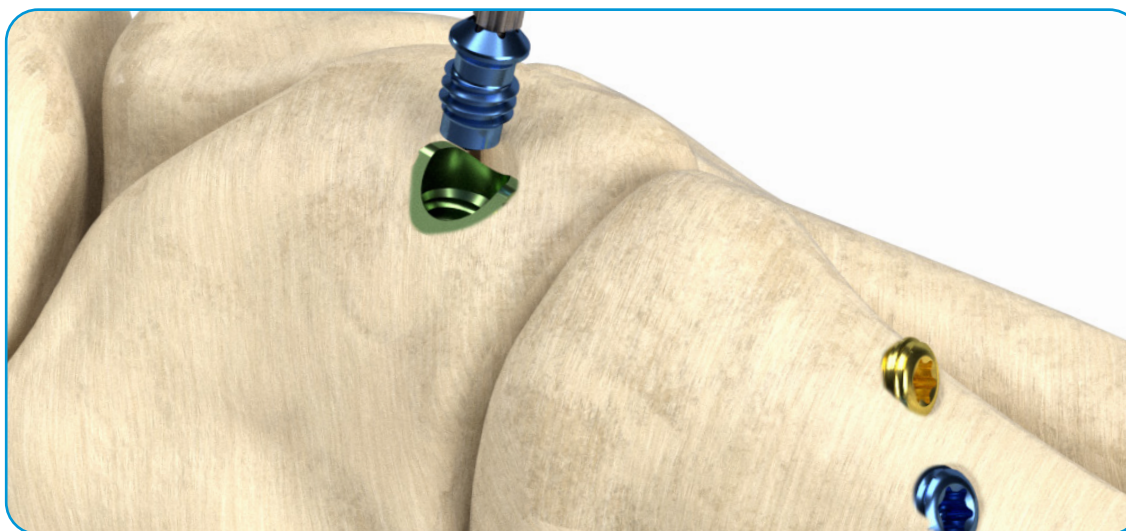

- 23.** Close in the usual manner.

Revision Surgical Technique

1. Make a dorsal incision over the tarsometatarsal joint.
2. Locate the **Post** in the cuneiform and clear bone to gain access.
3. Remove the **Post Plug Screw** using the **T10 InCore Lapidus Driver**.
4. Align the **Revision Guide** with the **Post**. Place the **Revision Post Fastener** through the **Revision Guide** and thread onto the **Post**. Hand tighten to stabilize the assembly.

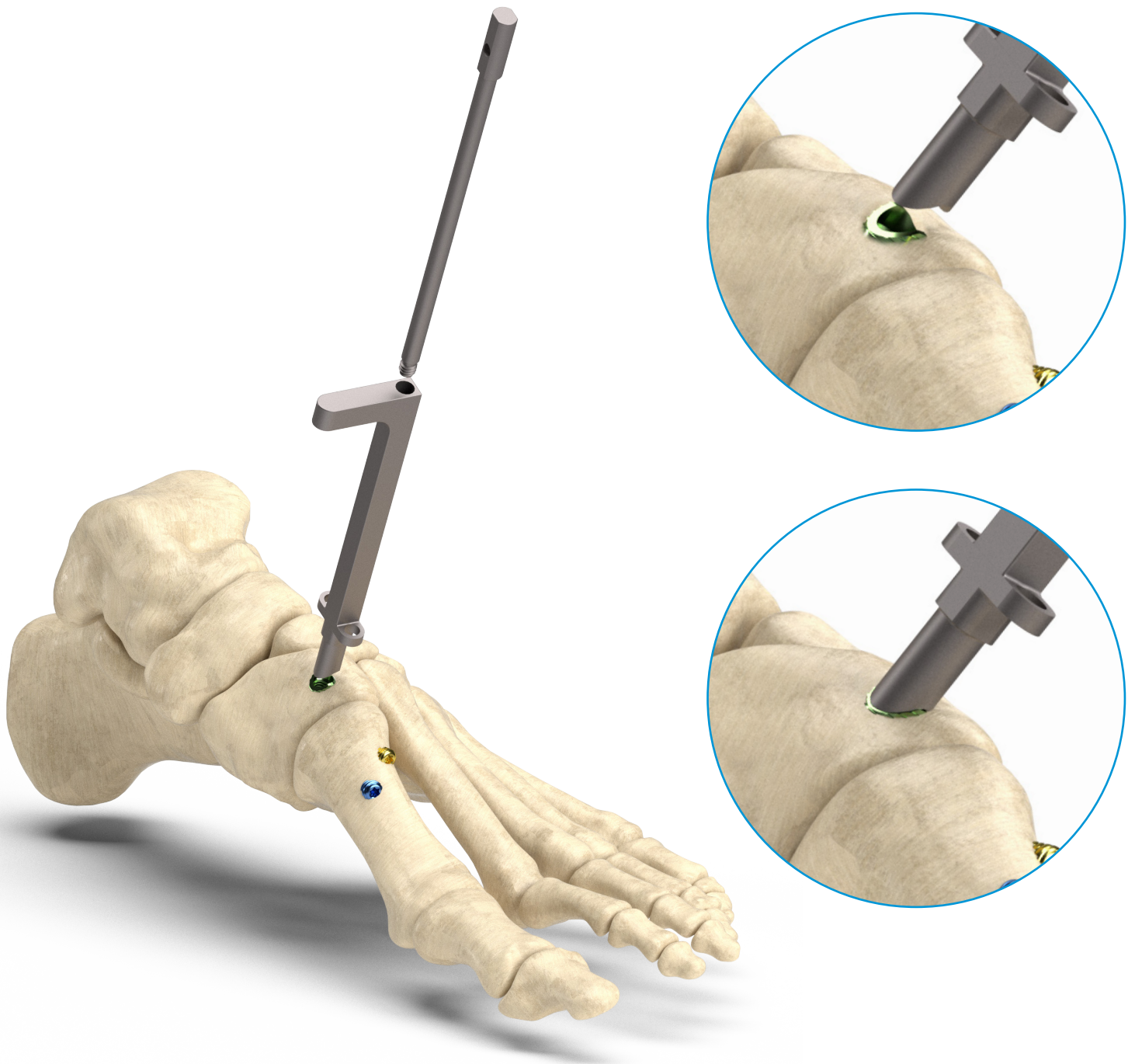

5. Locate the **3.5mm Screws** in the metatarsal and clear bone to gain access.
6. Remove both **3.5mm Screws** using the **T10 InCore Lapidus Driver**.
7. Review of removed screws and X-ray will indicate the presence of potential screw fragments. Long screw fragments should be removed using a standard screw removal system. If one or both screws have broken, leaving a small portion of the screw locked into the **Post**, run the **3.6mm Drill** through the guided hole on the side of the **Revision Guide** parallel to the **Post** until the screw fragment is reached.

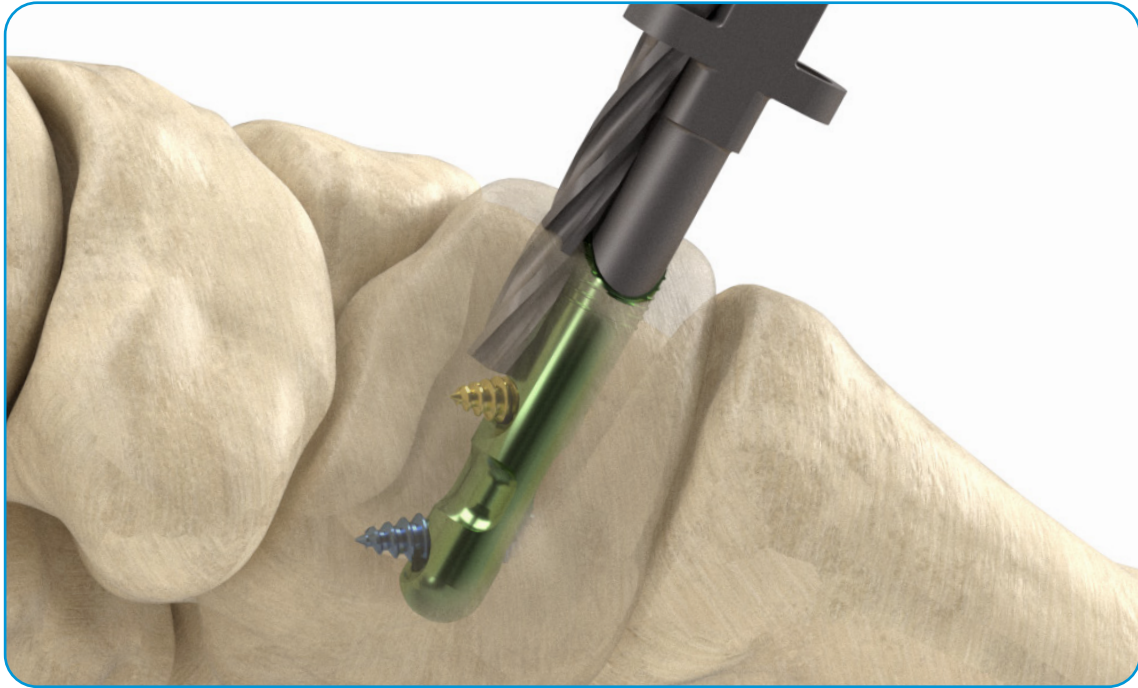

8. The **Revision Guide** can then be impacted dorsally to remove the **Post**.
9. If additional in-line force is required, the **Slap Hammer** can be attached by removing the **Revision Guide**, sliding the **Revision Post Fastener** through the **Slap Hammer** and reengaging with the **Post**.

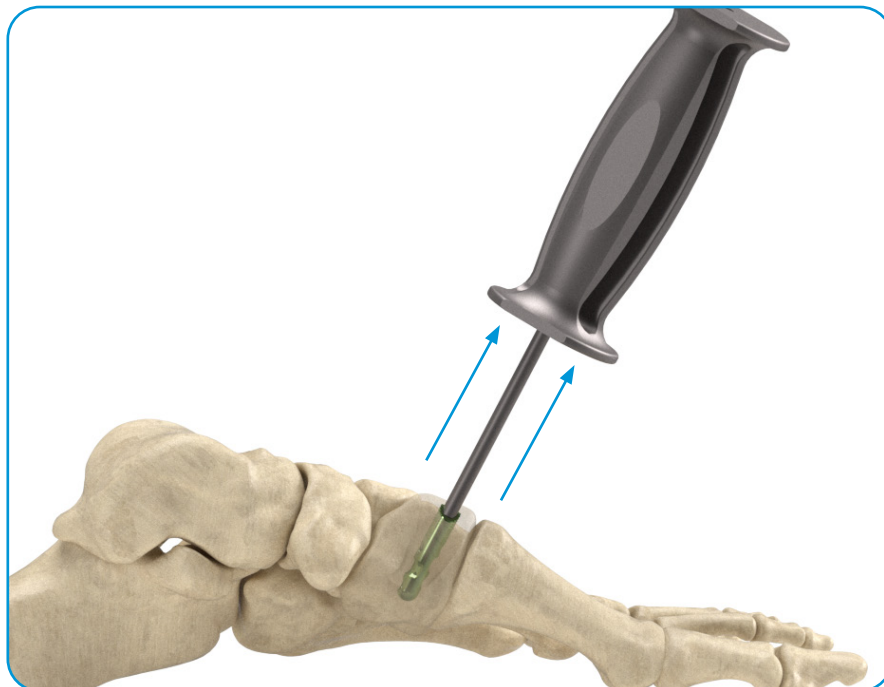

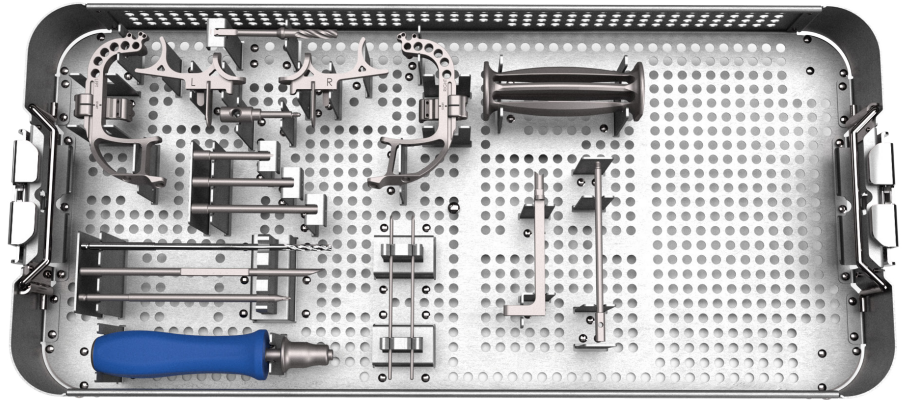

ORDERING INFORMATION

IMPLANTS

Part No.	Description
IC-LAP-5928RP	InCore Lapidus 5.9mm x 28mm Right Titanium Post
IC-LAP-5928LP	InCore Lapidus 5.9mm x 28mm Left Titanium Post
IC-LAP-3524	InCore Lapidus 3.5mm x 24mm Titanium Screw
IC-LAP-3526	InCore Lapidus 3.5mm x 26mm Titanium Screw
IC-LAP-3528	InCore Lapidus 3.5mm x 28mm Titanium Screw
IC-LAP-3530	InCore Lapidus 3.5mm x 30mm Titanium Screw
IC-LAP-3532	InCore Lapidus 3.5mm x 32mm Titanium Screw
IC-LAP-3534	InCore Lapidus 3.5mm x 34mm Titanium Screw
IC-LAP-3536	InCore Lapidus 3.5mm x 36mm Titanium Screw
IC-LAP-3538	InCore Lapidus 3.5mm x 38mm Titanium Screw
IC-LAP-3540	InCore Lapidus 3.5mm x 40mm Titanium Screw
IC-LAP-3542	InCore Lapidus 3.5mm x 42mm Titanium Screw
IC-LAP-3544	InCore Lapidus 3.5mm x 44mm Titanium Screw
IC-LAP-3546	InCore Lapidus 3.5mm x 46mm Titanium Screw
IC-LAP-3548	InCore Lapidus 3.5mm x 48mm Titanium Screw
IC-LAP-3550	InCore Lapidus 3.5mm x 50mm Titanium Screw
IC-LAP-3552	InCore Lapidus 3.5mm x 52mm Titanium Screw
IC-LAP-3554	InCore Lapidus 3.5mm x 54mm Titanium Screw
IC-LAP-3556	InCore Lapidus 3.5mm x 56mm Titanium Screw
IC-LAP-35P	InCore Lapidus Post Plug Screw
Disposable Kit	
IC-LAP-28R	InCore Lapidus Disposable Kit 28mm - Right
IC-LAP-28L	InCore Lapidus Disposable Kit 28mm - Left
Replacement Items for Targeting Guide Assembly	
IC-LAP-0104	InCore Lapidus Replacement Compression-Distractor Fixture
IC-LAP-0105	InCore Lapidus Replacement Compression Screw

INSTRUMENTS

Part No.	Description
IC-LAP-0100L	InCore Lapidus Post Guide Left Reusable
IC-LAP-0000R	InCore Lapidus Post Guide Right Reusable
IC-LAP-0101L	InCore Lapidus Targeting Guide Assembly Left Reusable
IC-LAP-0001R	InCore Lapidus Targeting Guide Assembly Right Reusable
IC-LAP-0106	InCore Lapidus 2mm x 4" K-Wire (qty 1) - 4 needed
IC-LAP-0107	InCore Lapidus Drill Bushing 40mm Reusable
IC-LAP-0108	InCore Lapidus Drill Bushing 55mm Reusable
IC-LAP-0109	InCore Lapidus Drill Bushing 70mm Reusable
IC-LAP-0112	InCore Lapidus Post Fastener Reusable
IC-LAP-0114	InCore Lapidus 5.9mm Post Drill Reusable
IC-LAP-0115	InCore Lapidus T10 Driver Reusable
IC-LAP-0116	InCore Lapidus 3.6mm Drill Bit Reusable
IC-LAP-0117	InCore Lapidus Removal Drill Guide Reusable
IC-LAP-0118	InCore Lapidus Removal Slap Hammer Reusable
IC-LAP-0119	InCore Lapidus Removal Fastener Reusable
IC-LAP-0120	InCore Lapidus Depth Probe Reusable
IC-LAP-0131	InCore Lapidus Torque Limiting Handle Reusable
IC-LAP-0122	InCore Lapidus Instrument Case
IC-LAP-0123	InCore Lapidus Instrument Case Lid
IC-LAP-TH20	Torque Limiting Handle 2NM - Sterile
IC-LAP-T10	InCore Lapidus T10 Driver - Sterile
IC-LAP-D36	InCore Lapidus 3.6mm Drill Bit - Sterile
IC-LAP-KW20	K-Wire 2.0mm x 102mm (qty. 4) - Sterile

REFERENCES

- Cottom, James M. and Vora, Anand M. Fixation of Lapidus Arthrodesis with a Plantar Interfragmentary Screw and Medial Locking Plate: A Report of 88 Cases. The Journal of Foot & Ankle Surgery. 52 (2013) 465-469
- Peterson, Kyle S. et al. Symptomatic Hardware Removal After First Tarsometatarsal Arthrodesis. The Journal of Foot & Ankle Surgery. 55 (2016) 55-59.

INDICATIONS: The Nextremity Solutions InCore™ Lapidus System is a three-part construct intended for internal fixation for First Metatarsocuneiform arthrodesis (also known as Lapidus or First Tarsometatarsal Fusion).

CONTRAINDICATIONS: (1) Patient conditions including insufficient quantity or quality of bone. (2) Blood supply limitations and previous or active infections that may inhibit healing. (3) Surgical procedures other than for the indications listed. (4) Patients with conditions that limit their ability or willingness to follow postoperative care instructions. (5) The device may not be suitable for patients with insufficient or immature bone. The physician should carefully assess bone quality before performing orthopedic surgery on patients who are skeletally immature. (6) Where material sensitivity is suspected, appropriate testing should be performed and sensitivity ruled out prior to implantation. (7) The InCore Lapidus System requires placement of a titanium post in the medial cuneiform bone. For optimum fixation strength, the post should be fully encapsulated in bone. The device may be unsuitable for patients with small, thin, bifurcated, split, fractured, or otherwise abnormally shaped bone.

This material is intended for health care professionals. Distribution to any other recipient is prohibited. For product information, including indications, contraindications, warnings, precautions, potential adverse effects and patient counseling information, see the package insert. Check for country product clearances and reference product-specific instructions for use.

Zimmer Biomet and Nextremity Solutions do not practice medicine. This technique was developed in conjunction with health care professionals. This document is intended for surgeons and is not intended for laypersons. Each surgeon should exercise his or her own independent judgment in the diagnosis and treatment of an individual patient, and this information does not purport to replace the comprehensive training surgeons have received. As with all surgical procedures, the technique used in each case will depend on the surgeon's medical judgment as the best treatment for each patient. Results will vary based on health, weight, activity and other variables. Not all patients are candidates for this product and/or procedure. Caution: Federal (USA) law restricts this device to sale by or on the order of a surgeon. Rx only.

Nextremity Solutions and InCore are trademarks of Nextremity Solutions, Inc. Zimmer Biomet is the exclusive distributor of the InCore Lapidus System.

The InCore Lapidus System is manufactured using Ti 6-4 ELI.

©2019 Nextremity Solutions

LIT-1554 Rev.03



Distributed by:

Zimmer, Inc.
1800 West Center St.
Warsaw, IN 46580 U.S.A.
(800) 613-6131
contactus@zimmerbiomet.com



Legal Manufacturer:

Nextremity Solutions, Inc.
210 N. Buffalo St.
Warsaw, IN 46580 U.S.A.
(732) 383-7901
nextremitysolutions.com