



Zimmer®
Nexel™
Total Elbow
Surgical Technique



Table of Contents

	PAGE
Indications / Contraindications	1
Pre-Operative Considerations	2
Surgical Technique Summary	3
<hr/>	
SECTION	
1. Surgical Preparation and Exposure	5
2. Humeral Preparation	7
3. Ulnar Preparation	12
4. Trial Reduction	16
5. Component Implantation	17
6. Final Assembly	23
7. Closure	25
8. Postoperative Management	26
9. Poly Revision	27
10. Component Removal	29

Device Description

This device is a total elbow prosthesis designed for use with bone cement. It is available in sizes 4, 5 and 6, in left and right configurations. The Ulnar and Humeral Components are manufactured from *Tivanium*® (Ti-6Al-4V) alloy. The Ulnar Component has a porous coating of Ti-6Al-4V plasma spray and is curved to facilitate implantation. The Humeral Component has a porous coating of Ti-6Al-4V plasma spray and has an anterior flange to accommodate a bone graft. The Axle-Pin and Humeral Screws are manufactured from *Zimaloy*® (Co-Cr-Mo) alloy. Vitamin E highly cross-linked ultra-high molecular weight polyethylene (*Vivacit-E*®) bearings prevent metal-to-metal articulating contact.

Note: Size 4, 5 and 6 are numerical relative descriptions of the available girths of the Implant stems. 4, 5 and 6 do not imply or equate to a dimension. 4 does not equal 4 mm, and so on.

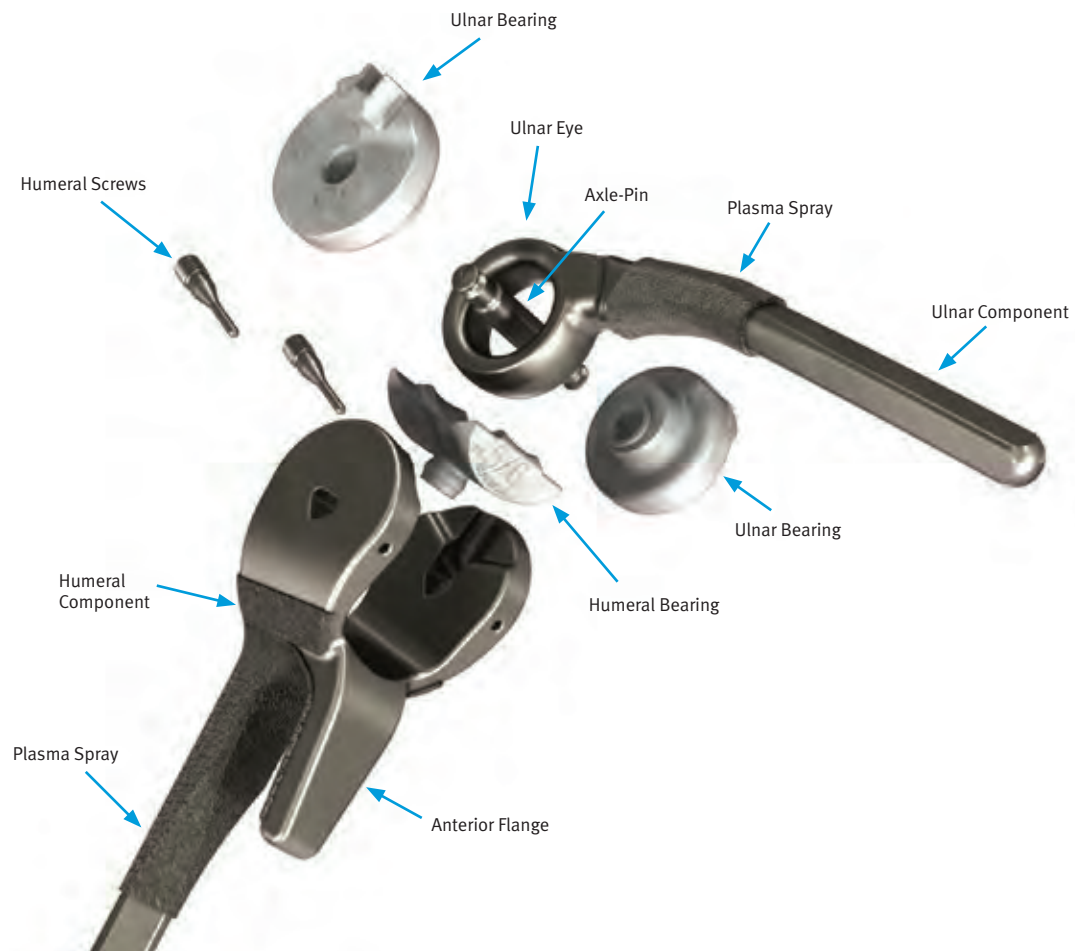

Indications / Contraindications

INDICATIONS

Indications for use include:

- Elbow joint destruction which significantly compromises the activities of daily living
- Post-traumatic lesions or bone loss contributing to elbow instability
- Ankylosed joints, especially in cases of bilateral ankylosis from causes other than active sepsis
- Advanced rheumatoid, post-traumatic, or degenerative arthritis with incapacitating pain
- Instability or loss of motion when the degree of joint or soft tissue damage precludes reliable osteosynthesis
- Acute comminuted articular fracture of the elbow joint surfaces that precludes less radical procedures, including 13-C3 fractures of the distal humerus
- Revision arthroplasty

Caution: *This device is intended for cemented use only*

CONTRAINDICATIONS

Use of the Zimmer® Nexel™ Total Elbow is contraindicated in patients with:

- Currently active, or history of repeated, local infection at the surgical site
- Paralysis or dysfunctional neuropathy involving the elbow joint
- Significant ipsilateral hand dysfunction
- Excessive scarring of the skin or soft tissue that could prevent adequate soft tissue coverage
- Daily activities that would subject the device to significant stress (i.e., heavy labor, torsional stress, and/or competitive sports)

Relative contraindications include:

- Distant foci of infection (e.g. genitourinary, pulmonary, skin [chronic lesions or ulcerations], or other sites). In cases of distant infection, the foci of infection should be treated prior to, during and after surgery.
- Ancient prior sepsis

Pre-Operative Considerations

- For those inexperienced in the technique of elbow arthroplasty, training with a cadaver specimen(s) is recommended to appreciate the soft tissue implications of the technique.
- Be aware of existing shoulder pathology; assess shoulder stiffness, avoid forceful rotation.
- Avoid overlapping cement mantles and/or interference between shoulder and elbow humeral stems, and/or a short cement gap between shoulder and elbow humeral stems as these are known fracture risks.
- Understand if a revision length stem is to be used and assess/accommodate for the amount of anterior bowing of the humerus on the lateral pre-operative radiographs.
- To address flexion contracture, consider counter sinking the Humeral Component to the extent that does not produce a fracture of the medial condyle.
- For proper orientation of the humeral component, understand the humeral osseous landmarks establishing the axis of flexion of the elbow. Medially, the landmark is a point at the anterior/inferior aspect of the medial condyle. Laterally, the landmark is the center of the capitellum (Fig. 0.0-0.2).

Recommended Power for Surgery

- Bur for opening ulnar canal.
- Microsagittal saw for removing trochlea.
- Power with high-speed attachment for trephine; 1000 rpm's minimum.
- Power with reamer attachment for ulnar reamers.
- Oscillating saw blade for making verticle humeral cuts using cut guide; 1.27mm blade width and ~3" long.

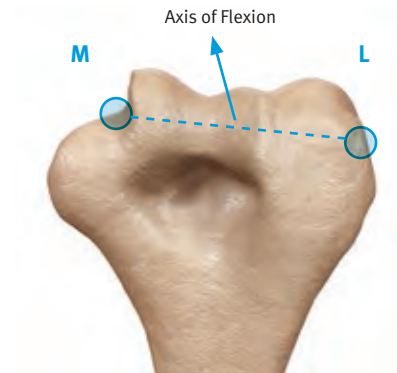

Fig. 0.0

Posterior View

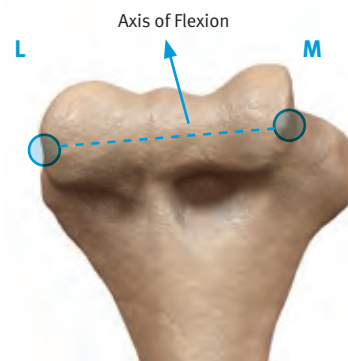

Fig. 0.1

Anterior View

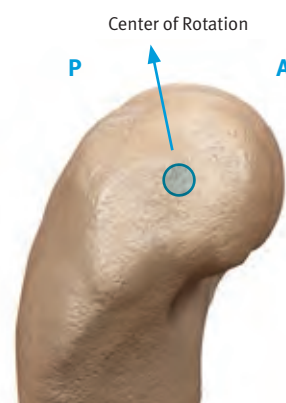

Fig. 0.2

Lateral View

Surgical Technique Summary



Fig. 2.1

Use saw or ronguers to remove trochlea and access humeral canal.

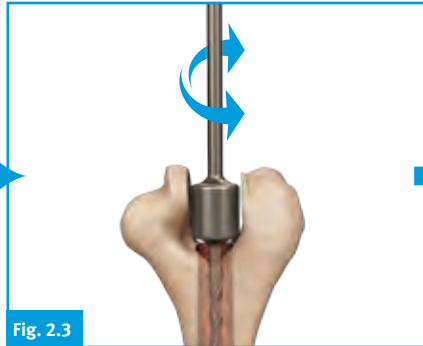

Fig. 2.3

Use Humeral Awl Reamer to open canal and confirm readiness for Rasps.

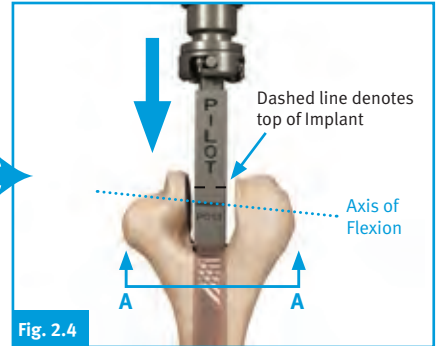

Fig. 2.4

Sequentially Rasp the canal; solid line needs to align with the axis of flexion.

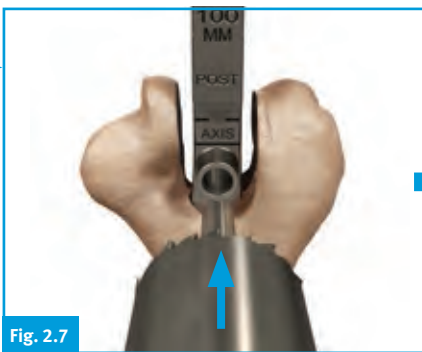

Fig. 2.7

Score the bone, and create rounded humeral cut by using the Trephine saw.



Fig. 2.11

Secure the Humeral Cut Guide by inserting the Pin, then make vertical cuts using oscillating saw.

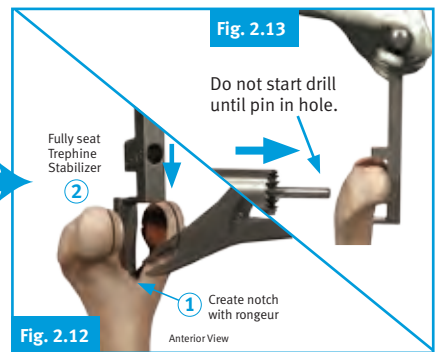

Fig. 2.13

Fig. 2.12

Fully seat the Trephine Stabilizer until the marking aligns with the axis of Flexion (notch anterior humerus), and finish the Trephine cut.



Fig. 2.14

Assess Humeral bone preparation with Provisional.

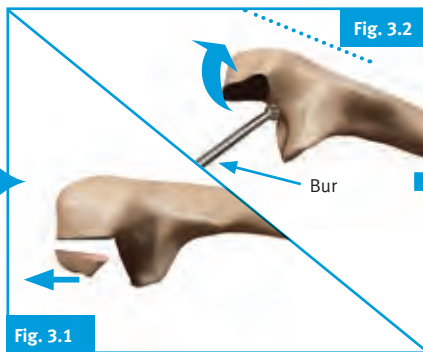

Fig. 3.1

Remove tip of the olecranon and open ulnar canal with a bur.

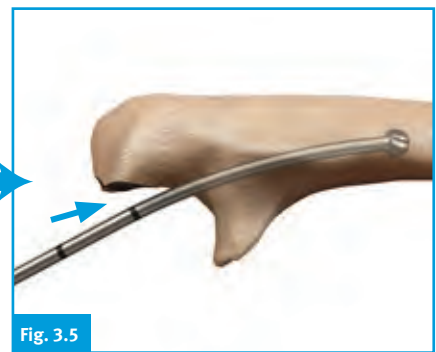

Fig. 3.2

Prepare the distal ulna using Flexible Reamers, Solid followed by Cannulated, until marking aligns with chosen length Implant.

Surgical Technique Summary

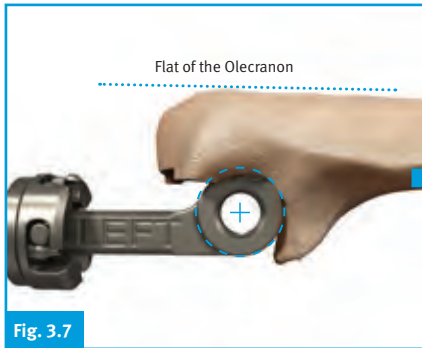

Fig. 3.7

Prepare the proximal ulna using sequential Rasps, until hole feature on Rasp aligns with axis of flexion.

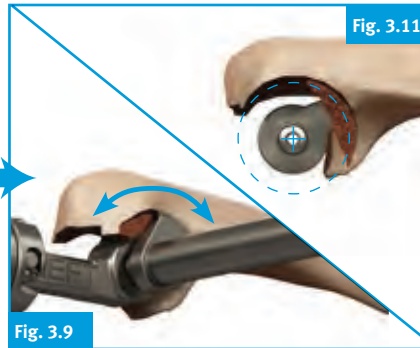

Fig. 3.9

After using the Ulnar Bearing Clearance Template to confirm adequate clearance for Implant, assess the ulnar preparation using the Ulnar Provisional.

Fig. 3.11



Fig. 4.1

Reduce joint and perform a trial range of motion.



Fig. 5.1

Retrograde fill the ulnar canal with cement.



Fig. 5.2

Use Ulnar Stem Inserter to fully seat implant, then remove Cement Diverter.



Fig. 5.4

Retrograde fill the humeral canal with cement.



Fig. 5.5

Insert bone graft under the anterior flange and use the Humeral Stem Inserter to fully seat the Implant.

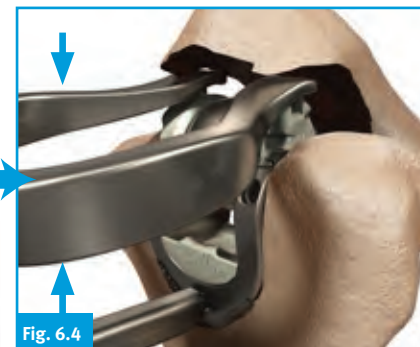

Fig. 6.4

Partially reduce the joint with hand pressure, then fully reduce it using the Articulation Inserter. (Alternate: Ulnar Bearing Tamp is used with the triceps-on exposure.)



Fig. 6.6

Bearings will be flush with top of Implant when fully seated, and Humeral Screws will thread in easily using Elbow Torque Driver.

1. Surgical Preparation and Exposure

1.1 Patient Preparation

- Position the patient.
 - Position patient in supine with a sandbag under the scapula.
 - Place the arm across the chest.
- Place a rolled towel under elbow.

TECHNIQUE TIP

1.2

A more midline positioned incision decreases the need for elevating an extensive flap.

1.2 Incision

- Make a straight incision approximately 15cm in length.
 - Center incision over the elbow joint just lateral to the medial epicondyle and just medial to the tip of the olecranon (Fig. 1.1).

1.3 Ulnar Nerve Protection

- Isolate the ulnar nerve.
 - Identify the medial aspect of the triceps mechanism.
 - Use ocular magnification and a bipolar cautery as necessary.
- Mobilize the ulnar nerve to the first motor branch.
- Very carefully translocate the nerve anteriorly into the subcutaneous tissue (Fig. 1.2).

Note: Carefully protect the nerve throughout the remainder of the procedure.

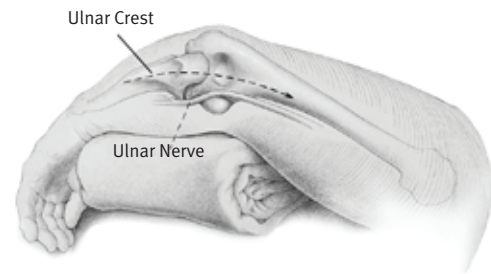

Fig. 1.1

Incision just lateral to medial epicondyle.

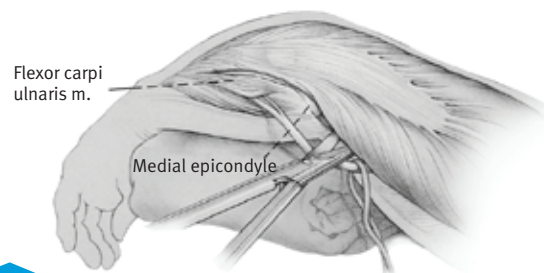

Fig. 1.2

Translocate ulnar nerve to subcutaneous tissue.

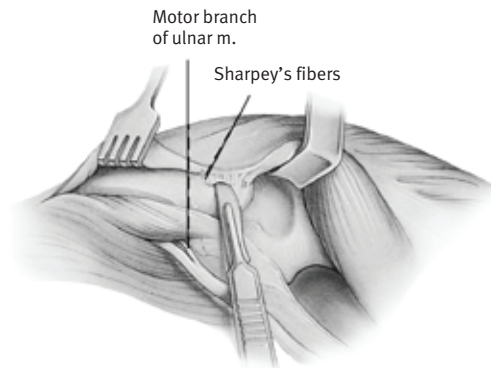

Fig. 1.3

Remove triceps from the proximal ulna.

1.4 The Bryan/Morrey Approach*

The Bryan/Morrey approach is recommended for new and inexperienced users of the *Nexel* Total Elbow System. This approach employs a meticulous repair of the triceps that is detailed at the end of this surgical technique. Once experience is gained, other exposures (e.g., Triceps-On/Sparing) can be employed at the surgeon's discretion.

- Release the triceps (Fig. 1.3 previous page).
 - Make an incision over the medial aspect of the ulna.
 - Elevate the ulnar periosteum along with the forearm fascia.
- Expose distal humerus, proximal ulna and radial head (Fig 1.4)
 - Retract the medial aspect of the triceps along with the posterior capsule.
 - Remove the triceps from the proximal ulna by releasing the Sharpey's fibers from their insertion
 - Further reflect the extensor mechanism laterally including the anconeus.
 - Transpose the entire extensor mechanism (triceps, ulnar periosteum, and anconeus) as a single soft-tissue sleeve laterally.
- Expose and dislocate the joint.
 - Release the medial and lateral collateral ligaments from their humeral attachment (Fig. 1.5).
 - Flex the elbow to disarticulate the ulna from the humerus (Fig. 1.6).
 - Externally rotate the forearm to allow further flexion and separation of the articulation.
 - Release the anterior capsule and contracted soft tissue from the distal humerus (Fig. 1.7).

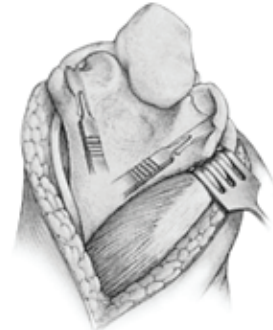

Fig. 1.4

Transpose the extensor mechanism laterally.

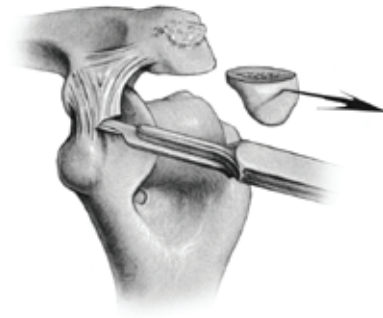

Fig. 1.5

Release medial and lateral collateral ligaments.

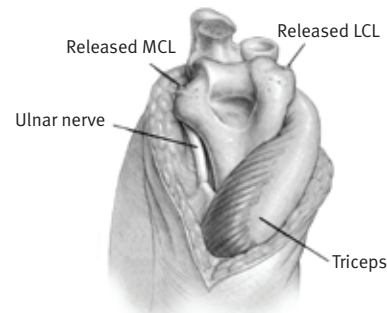

Fig. 1.6

Flex elbow to disarticulate ulna from humerus.



Fig. 1.7

Release anterior capsule from distal humerus.

TECHNIQUE TIP

1.4

A complete release of the soft tissues from the medial aspect of the distal humerus protects the medial epicondyle from fracture during flexion and manipulation of the forearm. Elbows with severe arthritis, post-traumatic surgery, and/or extensive soft-tissue contractures should undergo releases of the capsule and extensor/flexor origins to facilitate motion and soft tissue balance.

* Morrey, Bernard F., *The Elbow and its Disorders*. 4th. Philadelphia, PA: Saunders Elsevier, 2009.

2. Humeral Preparation

Note: Be aware that instruments labeled size “5/6” can be used for a size 5 or 6 implant; likewise, instruments labeled size “4/5” can be used for a size 4 or 5 implant.

2.1 Trochlear Resection

- Resect the central portion of the trochlea (Fig. 2.1).
 - Use a saw or a rongeur as appropriate.
 - Retain resected bone for the anterior bone graft (Section 5.1).

TECHNIQUE TIP

2.1

The bone graft can be harvested at this time by first making a center cut, followed by additional medial or lateral cuts.

2.2 Humeral Canal Exposure

- Identify and expose the humeral canal (Fig. 2.2).
 - Use a bur or rongeur at the proximal base of the olecranon fossa.

2.3 Humeral Canal Reaming

- Use the Humeral Awl Reamer to open the humeral canal (Fig. 2.3).

Note: The Humeral Awl Reamer should be centered and fit through the previously resected middle portion of the trochlear cut, otherwise remove more bone until it fits; this ensures clearance for the width of the Humeral Rasp.



Fig. 2.1

Use oscillating saw to remove trochlea.

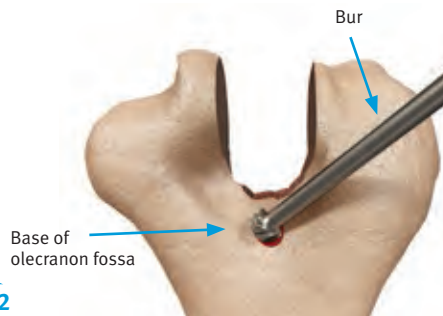

Fig. 2.2

Use bur to expose humeral canal.

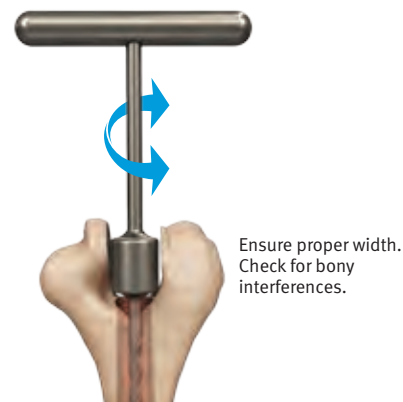

Fig. 2.3

Use Humeral Awl Reamer to open canal.

Instruments



Humeral Awl Reamer
00-8401-060-00

SCRUB NURSE

Rasp Connections

- A. The Rasps attach to the T-Handle by pushing and twisting them together. An audible click will be heard.

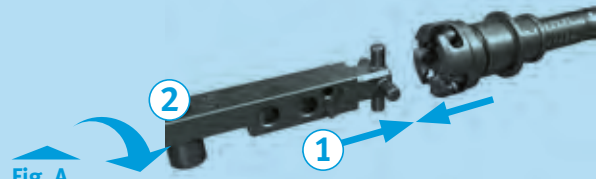

Fig. A
Connect Rasps to T-Handle.

2.4 Humeral Canal Rasing

- Use the Pilot Humeral Rasp to initiate canal preparation.
 - Gently impact the Rasp until the solid etched line is coincident with the axis of flexion (Fig. 2.4).
- Progressively rasp until the desired size and fit is achieved (see table).
 - Place the Internal/External Alignment Rod perpendicularly through the Rasp to assist with determination of axial alignment (Fig. 2.5).
- Do not remove the final Humeral Rasp or the T-Handle.

Final Rasp by Implant Size/Length			
Implant Size	Implant Length (mm)		
	100	150	200
4	4-100	4-150	n/a
5	5-100	5-150	5-150
6	6-100	6-150	6-150

Note: While rasping, keep the flat posterior side of the Humeral Rasp approximately parallel to the plane formed by the posterior cortices of the medial and lateral columns at the level of the roof of the olecranon fossa (Fig. 2.6). If these landmarks are not available, use the relatively flat posterior surface of the distal humeral shaft to approximate this plane.

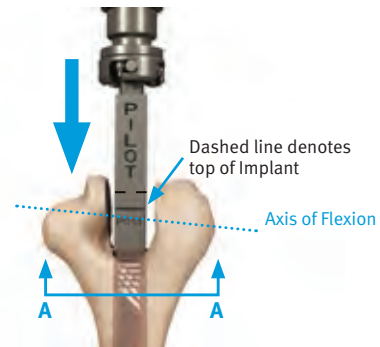

Fig. 2.4
Sequentially Rasp the canal; solid line needs to align with the axis of flexion.

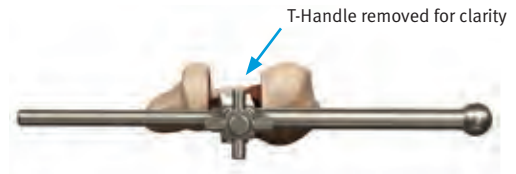

Fig. 2.5
Use Internal/External Alignment Rod to assess axial alignment.

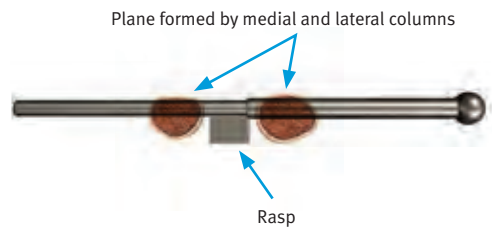

Fig. 2.6
Cross-section A-A with Internal/External Alignment Rod inserted through Rasp.

TECHNIQUE TIP 2.1

Flexible Cannulated Reamers are available if difficulty is encountered during rasping. (Sizes 8-12 mm located in the Revision Case.)

Instruments



2.5 Initial Trephine Cut

- Identify the position of the rounded humeral cut.
 - Use the appropriate size-matched Trephine based on the final Rasp. (Size 5-100 Rasp and 5/6 Trephine shown for example - Fig. 2.7).
 - Insert the pilot pin into the Rasp and carefully advance the Trephine's pilot pin until the depth stop is reached (Fig. 2.7).
 - Score the posterior surface of the distal humerus (Fig. 2.8). This provides a reference for the final preparation.

Note: Irrigation should be employed during cutting to reduce heat generation.

Note: The Size 4 Trephine has a slightly different pilot pin diameter than the Size 5/6 to prevent mismatch from occurring between the Trephine and Humeral Rasps.

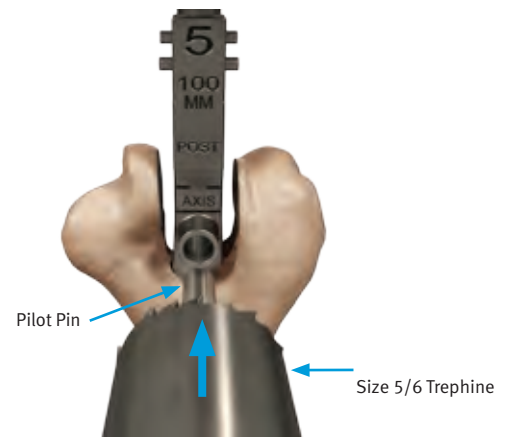

Fig. 2.7

Advance until Trephine reaches depth stop.



Fig. 2.8

View of bone after initial Trephine cut.

Instruments



Humeral
Rasp
00-8401-065-10



Trephine
00-8401-075-00

2.6 Trochlear Excision

- Excise the remaining trochlea using the Humeral Cut Guide.
 - Attach the size-matched Humeral Cut Guide to the Humeral Rasp (Fig. 2.9).
 - Stabilize the Humeral Cut Guide with the Humeral Bearing Driver Pin if desired (Fig. 2.10).
 - Use an oscillating or reciprocating saw through the Humeral Cut Guide slots (Fig. 2.11).

Note: Assess the preliminary humeral preparation. If it is determined that the Humeral Component needs to be inserted further proximally, the T-Handle/Rasp can be impacted to the desired depth and steps 2.4–2.6 are repeated as necessary.

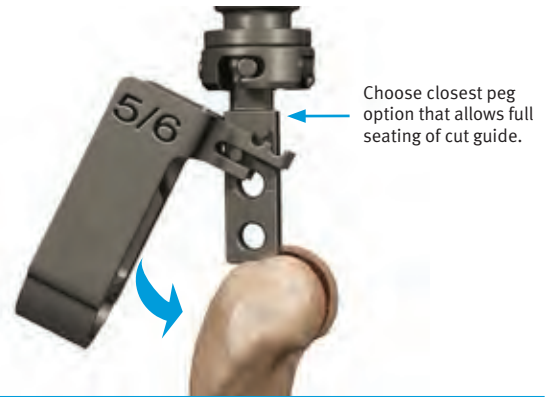

Fig. 2.9

Attach the Humeral Cut Guide to the Rasp.



Fig. 2.10

Insert the Pin to secure the Guide in place.



Fig. 2.11

Secure the Humeral Cut Guide by inserting the Pin, then make vertical cuts using oscillating saw.

Instruments



Humeral Rasp
00-8401-065-10



Humeral Bearing Driver Pin
00-8401-079-00



Humeral Cut Guide
00-8401-005-00



T-Handle
00-8401-002-00

2.7 Final Trepine Cut

- Complete the rounded humeral cut.
 - Insert the Trepine Stabilizer into the humeral canal.
 - Notch the coronoid fossa (anterior cortex) with a bur or rongeur to achieve proper depth of insertion of the Trepine Stabilizer (Fig. 2.12).
 - Insert the Trepine's pilot pin into the Trepine Stabilizer and drill while gently advancing the Trepine to its depth stop (Fig. 2.13).

TECHNIQUE TIP

2.2

Similar to the Humeral Rasps, the Trepine Stabilizer has etch lines on its posterior side indicating the axis of flexion (solid line), and the distal "top" of the Humeral Component (dashed line).

2.8 Humeral Canal Assessment

- Insert the appropriate size-matched Humeral Provisional into the humeral canal.
 - Ensure the Humeral Provisional is fully seated. If necessary, use a mallet to lightly tap Provisional to final depth.
 - The distal aspect of the Humeral Provisional should not sit proud relative to the distal aspect of the lateral humeral condyle.
- Use a rongeurs to trim any excess condylar bone distal to the Provisional (Fig. 2.14).
- Remove the Humeral Provisional. Use the Humeral Bearing Driver Pin to assist as needed (Fig. 2.14).

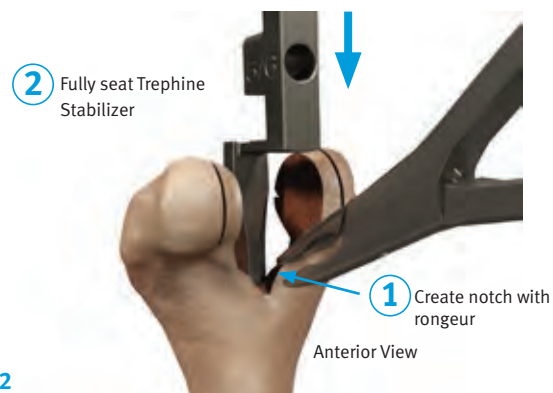

Fig. 2.12

Notch anterior cortex to allow Stabilizer to fully seat.



Fig. 2.13

Finish the Trepine cut using Stabilizer.

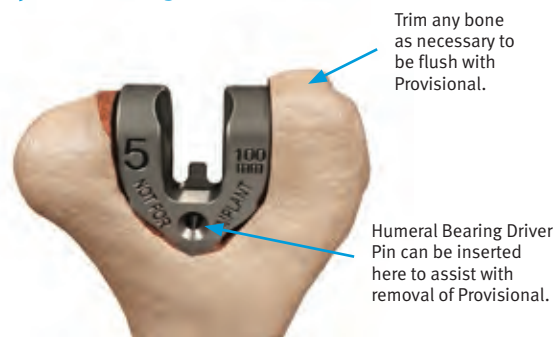

Fig. 2.14

Assess Humeral bone preparation with Provisional.

Instruments



Humeral Provisional
00-8401-045-10



Trepine
00-8401-075-00



Trepine Stabilizer
00-8401-012-05



Humeral Bearing Driver Pin
00-8401-079-00

3. Ulnar Preparation

Note: Be aware that instruments labeled size “5/6” can be used for a size 5 or 6 implant; likewise, instruments labeled size “4/5” can be used for a size 4 or 5 implant.

Note: Excessive resection of the olecranon compromises the re-attachment of the triceps mechanism and weakens the olecranon process. Inadequate resection tilts the intramedullary Rasp causing malalignment of the Ulnar Component and risks perforation of the dorsal ulnar cortex.

3.1 Ulnar Canal Exposure

- Remove the tip of the olecranon using an oscillating saw (Fig. 3.1).
- Use a high-speed bur to open the medullary canal at the base of the coronoid (Fig. 3.2).

3.2 Ulnar Canal Reaming

- “Notch” the olecranon.
 - Notch the olecranon using a bur or rongeur (Fig. 3.3).
 - The notch should be aligned and deep enough such that in-line access to the ulnar canal can be achieved with the Reamers/Rasps.
- Open the canal using the Ulnar Awl Reamer (Fig. 3.4).
 - Place fingers along the exposed shaft of the ulna to help identify the location of the ulnar shaft distal to the coronoid to prevent violation of the cortices distally.



Fig. 3.1

Remove tip of olecranon.

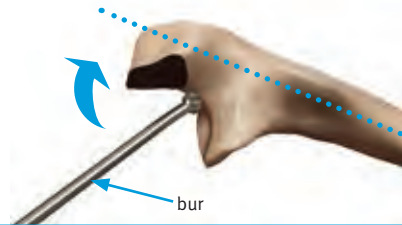

Fig. 3.2

Enter ulnar canal with bur.



Fig. 3.3

Create notch with rongeur.



Fig. 3.4

Enter ulnar canal with Ulnar Awl Reamer.

Instruments



Ulnar Awl
Reamer

31-8106-168-00

Note: Flexible Reamers must be used for ulnar canal preparation. They are used to expand the canal prior to rasping and fully prepare the distal portion of the canal for implantation. They must be used progressively beginning with the smallest 4.5mm Flexible Solid Reamer. DO NOT skip sizes, or attempt to begin with larger cutting head sizes.

- Progressively ream the ulnar canal until the desired size is achieved (see table).
 - Start with the Flexible Solid Reamers.
 - Ream to the depth marking (75, 90 or 115 mm) based on the desired Implant length (Fig. 3.5).
 - Continue reaming with Flexible Cannulated Reamers as necessary depending on chosen implant size.
 - Use with Sterile Ball Tip Guide Wire 2.4 x 70 to avoid cortical penetration as necessary depending on chosen implant size.

Ulnar Reaming			
Size Ulnar Component	4	5	6
Final Flexible Reamer (mm)	4.5	6.5	7.0

Note: Flexible Cannulated Reamers do not have depth markings and can be marked with a surgical marker (Fig. 3.6).



Fig. 3.5

Ream canal with Flexible Reamers to depth mark.

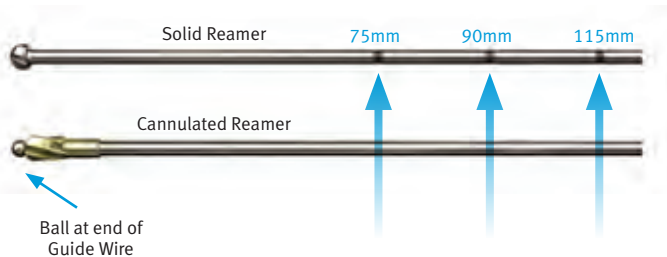
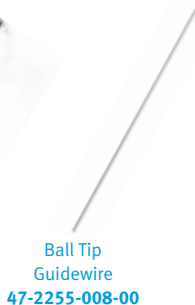

Fig. 3.6

Mark Cannulated reamers with surgical marker.

Instruments



3.3 Ulnar Canal Rasping

Note: Keep the flat posterior surface of the Rasp parallel to the relatively flat surface of the posterior aspect of the olecranon in both the coronal and sagittal planes (Fig. 3.7 & 3.8).

- Continue ulnar canal preparation with the Pilot Ulnar Rasp.
 - Gently impact the T-Handle until the “eye” of the Rasp is concentric with the projected center of the sigmoid notch in the sagittal plane (Fig. 3.7).
- Progressively rasp until the desired size or fit is achieved.
- Do not remove the final Rasp or T-Handle.

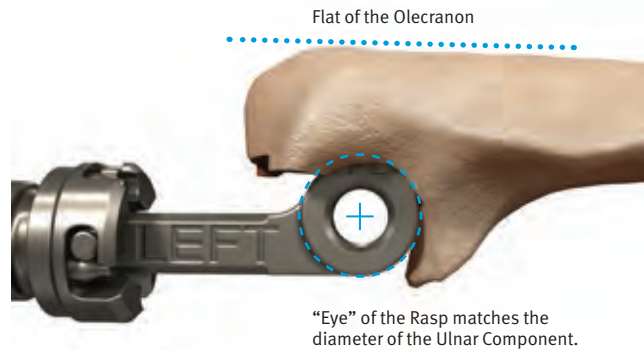

Fig. 3.7

Rasp canal until the “eye” is concentric with center of sigmoid notch.

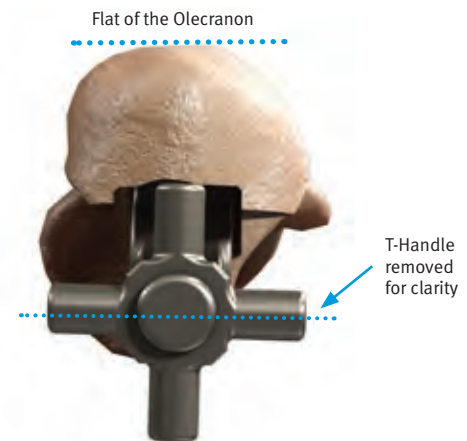
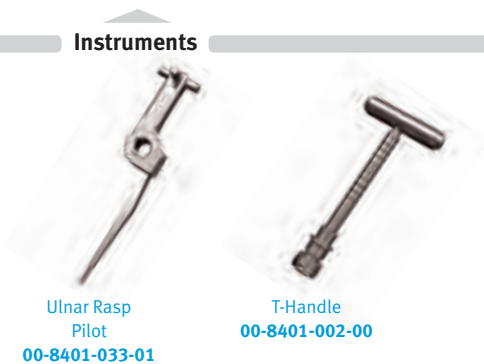

Fig. 3.8

Rasp is parallel to flat of the olecranon.

Instruments



Ulnar Rasp
Pilot

00-8401-033-01

T-Handle

00-8401-002-00

3.4 Sigmoid Notch Preparation

- Ensure adequate clearance exists around the sigmoid notch to allow articulation.
 - Place the Ulnar Clearance Template through the Ulnar Rasp (Fig. 3.9).
 - Score the bone surface by rotating the Template around the sigmoid notch, while supporting Rasp/T-Handle.
 - Withdraw the Template and remove the remaining bone within the scoring and any other osseous impingements with a bur.
 - Repeat on the opposite side.
- Reinsert the Template on each side of the Rasp to confirm adequate bone has been removed and to achieve impingement-free device articulation.

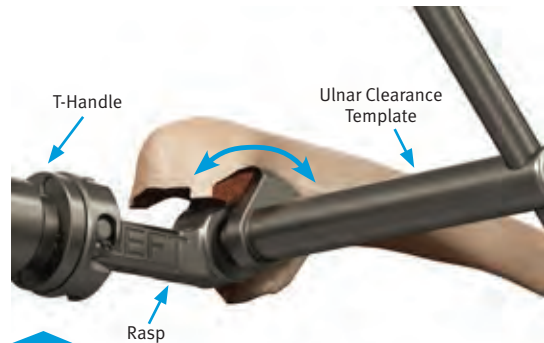

Fig. 3.9

Use Ulnar Clearance Template to confirm sufficient bone removal.

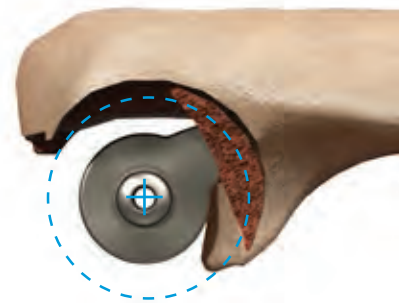

Fig. 3.10

Insert Ulnar Provisional to assess ulnar bone preparation.

3.5 Ulnar Canal Assessment

Warning: Do not cement the Ulnar Provisional

- Assess ulnar canal depth of preparation.
 - Insert the appropriate size/length Ulnar Provisional into the Ulnar canal.
 - If necessary, use a mallet to lightly impact the Ulnar Provisional to final depth.
 - Confirm that the center of the Ulnar Provisional is concentric with the projected center of the greater sigmoid notch (Fig. 3.10).
- Assess proper rotation of Ulnar Provisional.
 - Use the Humeral Bearing Driver Pin to confirm rotational and varus/valgus alignment (Fig. 3.11).

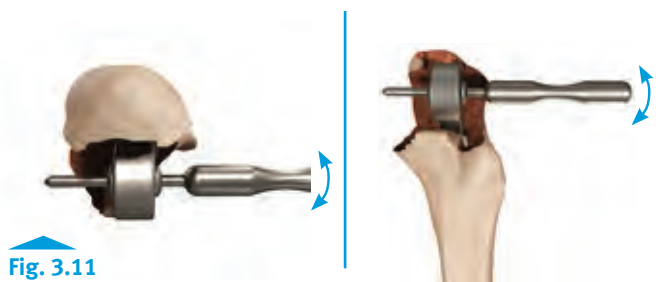
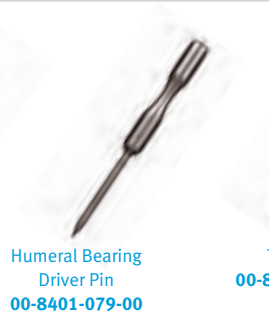
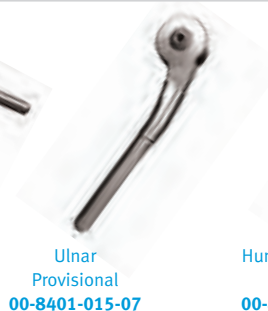

Fig. 3.11

Use Pin to assess alignment.

Instruments



4. Trial Reduction

4.1 Link Provisionals

- Connect the Provisionals and reduce the joint.
 - Re-insert the appropriate Humeral Provisional.
 - Slide the Ulnar Provisional into the Humeral Provisional (Fig. 4.1).

4.2 Evaluate Range of Motion

- Perform a trial range of motion.
 - Remove any osseous impingements. This could include all or portions of the radial head and coronoid process.
 - Perform any additional soft tissue releases as needed.
- Remove Provisionals
 - Use the Humeral Bearing Driver Pin to aid in Ulnar and Humeral Provisional removal as needed.

Note: Provisionals will provide varus/valgus and internal/external rotation laxity at the coupling similar to the final Implants.

Note: Causes for incomplete restoration of elbow extension include: inadequate depth of insertion of the Humeral Component, inadequate depth of insertion of the Ulnar Component, unresolved angular deformity, inadequate release of anterior, medial or lateral soft-tissue contracture and posterior bone impingement. Assess these factors prior to final component implantation.

Note: During the trial range of motion, it is important to check for coronoid impingement on the anterior flange, and to remove bone as necessary to obtain adequate flexion.



Fig. 4.1

Reduce the joint.

Instruments



Humeral
Provisional
00-8401-045-10



Ulnar
Provisional
00-8401-015-07



Humeral Bearing
Driver Pin
00-8401-079-00

5. Component Implantation

5.1 Prepare the bone graft

- Fashion a bone graft from the excised trochlea or radial head.
- If no bone from the elbow is available (in most revision cases) use either a bone graft from the radial head if still present, or the iliac crest or an allograft.

5.2 Prepare Canals for Cementing

- Prepare the humeral and ulnar canals for cementing.
 - Use copious irrigation to clean both medullary canals, then dry.
 - Insert Cement Restrictors as needed.

5.3 Load Bearings on Back-Table

SCRUB NURSE

Install the Humeral Bearing

- A.** Place the size-matched Humeral Bearing into the Humeral Component using the Humeral Bearing Placement Tool.
- The Humeral Bearing will not be fully seated at this stage.
 - Only the “pilot cylinder” of the peg feature should be inserted into the hole in the base of the yoke of the Humeral Component.
 - See last figure for proper orientation of the Humeral Bearing.
- B.** Position the Humeral Bearing Driver against articulation surface of the Humeral Bearing and insert the Humeral Bearing Driver Pin simultaneously through the Humeral Implant and the slots in the shaft of the Driver.
- The handle of Humeral Bearing Driver should be parallel to flat posterior face of Humeral Component.
 - Turn the T-Handle 90 degrees clockwise.
 - Resistance will be felt, but no audible click will occur.
- C.** The Humeral Bearing will be fully seated when there are no visual gaps when viewing from the posterior and the anterior sides of the Humeral yoke.

Note: Articulation Kits come in two sizes (4 and 5/6). Always match the Articulation Kit to the Humeral Component.

Articulation Kits

Humeral Stem Size	Articulation Kit Size
4	4
5	5/6
6	5/6

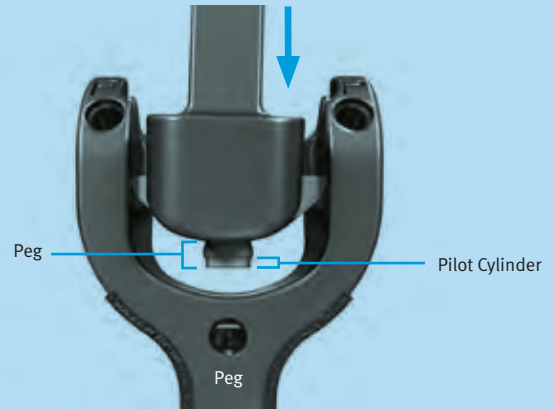

Fig. A

Place Humeral Bearing using Humeral Placement Tool.

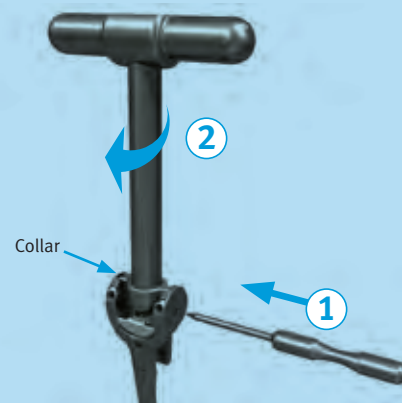

Fig. B

Position Driver, slide collar into Humeral slots, insert pin, turn Driver handle.



Fig. C

No Gaps should be present when bearing is fully seated.



Humeral Bearing Driver
00-8401-078-00



Humeral Bearing Placement Tool
00-8401-082-00



Humeral Bearing Driver Pin
00-8401-079-00

SCRUB NURSE**Install the Ulnar Bearings**

- A.** Load an Ulnar Bearing into one side of the Ulnar Bearing Assembly Tool (UBAT).
- B.** Load the Axle-Pin into the opposite jaw of the tool maintaining a finger-hold on the Axle-Pin.
- C.** Squeeze the handles.
 - Stop when hard resistance is felt – no audible click will be heard.
- D.** Load the second Ulnar Bearing.
 - DO NOT squeeze the second Bearing onto the Axle-Pin.

Note: Articulation Kits come in two sizes (4 and 5/6). Always match the Articulation Kit to the Humeral Component.

Articulation Kits

Humeral Stem Size	Articulation Kit Size
4	4
5	5/6
6	5/6



Fig. A

Lock bearings into spring loaded part of UBAT.



Fig. B

Maintain finger-hold on Axle-Pin.

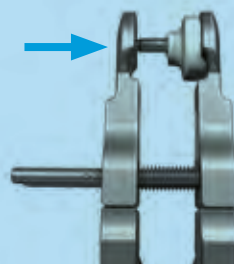

Fig. C

Squeeze UBAT to press Axle-Pin into Bearing.



Do not squeeze.

Fig. D

Load second Ulnar Bearing.



Ulnar Bearing
Assembly Tool
00-8401-081-00

- E.** Attach the Bearing/Axle-Pin assembly to the Ulnar Component.
- Carefully place the Axle-Pin through the eye of the Ulnar Component (Fig. E)
- F.** Squeeze the handles of the pre-loaded Ulnar Bearing Assembly Tool (UBAT) until hard resistance is felt.
- No audible click will be heard (Fig. F)

Note: Bearings/Axle-Pin assembly is designed to be loose fitting to the Ulnar eye.

Note: Use caution to avoid contact between the Axle-Pin and the Ulnar Component to avoid scratching the Implant.

- G.** Place two Diverters directly on the neck of the Ulnar Component. Do not slide the diverters up to the neck from the distal end of the implant (Fig. G).
- Diverters must be installed 180 degrees out of phase.
 - Diverter slits must be perpendicular to the ulnar eye axis.

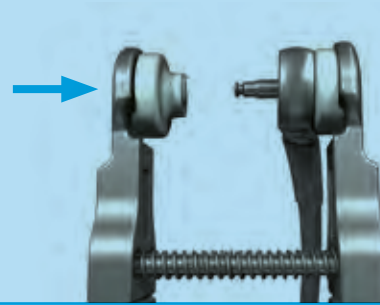

Fig. E

Use UBAT to place Bearings.



Fig. F

Use UBAT to attach bearings.



Fig. G

Installation of two Diverters.

Final installation.



Cement
Diverters
47-8401-038-00

Ulnar Bearing
Assembly Tool
00-8401-081-00

TECHNIQUE TIP

5.2

The use of high viscosity cement is difficult in smaller diameter cement nozzles used in elbow replacement. Be sure to inject the cement when still in the viscous state. Low viscosity cement is recommended.

5.4 Cement Ulnar Component

- Inject cement into the ulnar canal.
 - Cut the Cement Nozzle to the length of the Ulnar Component.
 - Leave approximately 1 cm of the proximal canal free of cement to avoid excessive backflow (Fig. 5.1).
- Insert the Ulnar Component into the canal.
- Fully seat and align the Ulnar Component (Fig. 5.2).
 - Use the Ulnar Stem Inserter to protect the articular surface of the Ulnar Component from damage during insertion.
 - Ensure the implant is perpendicular with the flat plane of the olecranon.
 - Center the Ulnar eye on the projected center of the greater sigmoid notch (Fig. 5.3).
- Remove excess cement from around the Ulnar Component.
 - Use the plastic *Quik-Use*® Curette to avoid scratching the Implant.
- Remove the Cement Diverters.

Note: It is recommended to remove the cement diverters after final positioning of the implant, but before the cement has fully hardened.

Note: Excess/loose cement can lead to third-body wear of the articulation.

Note: Only use the Ulnar Stem Inserter to seat the Ulnar Implant.



Fig. 5.1

Retrograde fill canal with cement.



Fig. 5.2

Use Ulnar Stem Inserter to fully seat Implant.



Fig. 5.3

Implant eye is concentric with the projected center of sigmoid notch.

Instruments

Ulnar Stem
Inserter

00-8401-028-00

Quik-Use
Curette

00-5049-053-00

Cement Restrictor
with Nozzle

32-8105-038-00

5.5 Cement Humeral Component

- Inject cement into the humeral canal.
 - Cut the Cement Nozzle to the length of the Humeral Component.
 - Leave approximately 1 cm of the distal canal free of cement to avoid excessive backflow (Fig. 5.4).
- Implant the Humeral Component into the humeral canal.
 - Before fully seated, wedge a bone graft between the flange of the Humeral Component and the anterior distal humeral cortex (Fig. 5.5).
 - Carefully impact the Humeral Component with the appropriate size-matched Humeral Stem Inserter to fully seat the Component (Figs. 5.5-5.6).
- Clear any excess bone cement with the plastic *Quik-Use* Curette.
- Allow cement to fully cure.

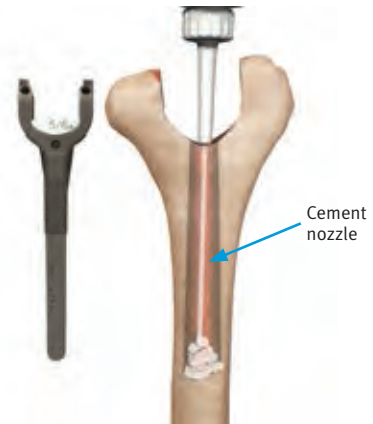

Fig. 5.4

Retrograde fill canal with cement.



Fig. 5.5

Insert bone graft and fully seat the Humeral Component using Humeral Stem Inserter.



Fig. 5.6

Cross-section view.

Instruments



Humeral
Stem Inserter
00-8401-058-05

Quik-Use
Curette
00-5049-053-00

Cement Restrictor
with Nozzle
32-8105-038-00

6. Final Assembly

6.1 Elbow Reduction

- Begin to reduce the joint.
 - Align the Axle-Pin and the tabs of the Ulnar Bearings to the slots in the Humeral Component (Fig. 6.1).
 - Partially reduce the joint by applying hand pressure to the forearm to drive the Axle-Pin and Bearings into the Humeral Implant.
- Finish reduction of joint.
 - To complete reduction of the joint, apply the Articulation Inserter.
 - Top of the Articulation Inserter fits into the Ulnar Bearing tab pockets.
 - Bottom of the Articulation Inserter fits into the proximal posterior hole in the Humeral Component (Fig. 6.2 & 6.3).
 - Squeeze the instrument until resistance is felt and Bearings are fully seated. No audible click will be heard.
 - The Ulnar Bearings should appear flush with the curved distal surfaces of the Humeral Component (Fig. 6.4).



Fig. 6.1

Align Bearing tabs and partially reduce joint.

Feet fit into Bearing tab pockets.



Fig. 6.2

Insert Peg in hole of Humeral Component and feet into the Bearing pockets.



Fig. 6.3

Use Articulation Inserter to squeeze together implants.

Align Bearing tabs with slots in Humeral Implant

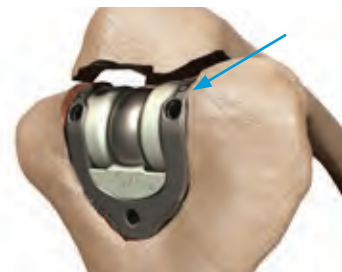

Fig. 6.4

Bearings will be flush with top of implant when fully seated.

Bearings should be flush with top of implant

TECHNIQUE TIP

6.3

The Ulnar Bearing Tamp is an alternate tool available to assist with alignment and insertion of the articulation, if access is unachievable with the Articulation Inserter (Fig. 6.5).

Instruments



Articulation Inserter
00-8401-019-00



Ulnar Bearing Tamp
00-8401-018-00

SCRUB NURSE**Screw Loading****A. Load Humeral Screw**

- Use the flexible plastic tubing to grasp the Humeral Screw.
- Thread Humeral Screw into the black-etched side of a Screw Holder.
- Remove and discard the tubing.
- Repeat with second Screw and second Screw Holder.

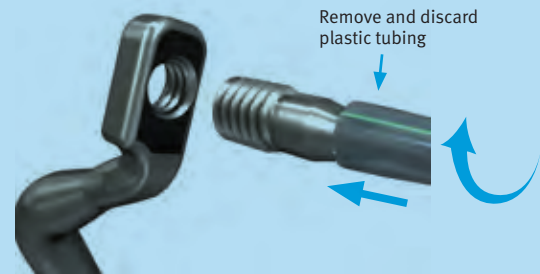
**Fig. A****Use Elbow Torque Driver to insert screws.****6.3 Humeral Screw Insertion**

Note: Proper application of torque to install the Humeral Screws is required for a successful prosthesis; only use the tools provided in the instrument set to apply torque.

Note: If Bearings are not flush with the Humeral Component, difficulty might be encountered during Humeral Screw insertion. Ensure Bearings are fully seated prior to inserting Screws (see section 6.1, Fig. 6.4).

Note: Never reuse any Humeral Screw after it has been installed to its prescribed torque, even if during same surgery. The Elbow Torque Driver is designed for single-surgery.

- Insert the screws.
 - Place the loaded Humeral Screw Holder against the posterior face of the Humeral Component and drive the Screw free of the Screw Holder; repeat on the other side.
- Sequentially tighten the Screws to the prescribed torque.
 - Lightly snug each Screw before final torquing either one.
 - Drive each Screw to the final torque with the Elbow Torque Driver until an audible “click” is heard (Fig. 6.7).
 - Dispose of Elbow Torque Driver when finished.

6.4 Final Range of Motion

- Perform a final range of motion.
 - Remove any impinging bone and address any soft tissue contractures.

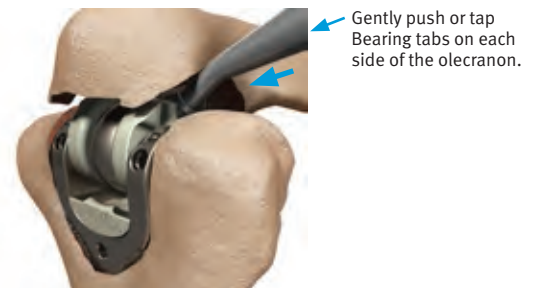
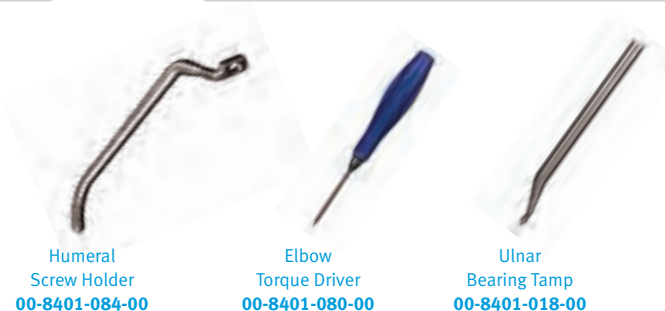
**Fig. 6.5****Use Ulnar Bearing Tamp to press bearings in place if needed.****Fig. 6.6****Use Elbow Torque Driver to insert screws.****Fig. 6.7****Lightly snug each Screw then achieve final torque “click.”****Instruments**

Humeral
Screw Holder
00-8401-084-00

Elbow
Torque Driver
00-8401-080-00

Ulnar
Bearing Tamp
00-8401-018-00

7. Closure

- Repair the triceps.
 - Place cruciate and transverse drill holes in the proximal ulna (Fig. 7.1).
- Perform cruciate repair of the triceps.
 - Reposition triceps.
 - Return triceps to a position that is slightly over-corrected from its anatomic position.
 - Pull the sleeve medially about 2 cm.
- Begin to suture and first locking stitch.
 - Start suture medially and directed laterally through the drill hole to capture the lateral triceps tendon with a locking stitch (Fig 7.2).
 - Use a #5 nonresorbable suture.
- Second locking stitch.
 - The suture is brought to the midline of the triceps and a second locking stitch is placed slightly more proximal and in the triceps tendon's midline.
- Third locking stitch.
 - The third locking stitch aligns with the medial tunnel in the olecranon and the suture is drawn through the tunnel emerging on the lateral aspect of the reflected mechanism.
 - It is brought through the sleeve of tissue from lateral to medial.
- Transverse Repair.
 - Start to suture medial to lateral through the olecranon (Fig. 7.3).
 - After piercing the lateral sleeve of tissue, it is brought to the midportion of the triceps tendon and a locking stitch is placed slightly proximal to the attachment after which it again pierces the medial aspect of the margin of the triceps.
 - Use #5 nonresorbable suture.
 - Tie sutures with the elbow in approximately 45 degrees of flexion.



Fig. 7.1

Drill holes in proximal ulna.



Fig. 7.2

Capture triceps tendon with locking stitch.



Fig. 7.3

Suture medial to lateral through the olecranon.

- Complete the closure in a routine fashion.
 - Stabilize the ulnar nerve in the anterior subcutaneous pocket.
 - Obtain hemostasis with bipolar cautery.
 - Close the wound in layers.
 - Insert a drain, if desired.
- Finish closure.
 - Apply a compressive dressing, use an anterior splint with the elbow in full extension and elevate the arm.

8. Postoperative Management

- Remove the drain, if used, the next day.
- Remove the compressive dressing on the first or second day after surgery.
- Instruct the patient on activities of daily living.
 - Typically, no formal physical therapy is required.
 - Avoid strengthening exercises.
 - Allow elbow flexion and extension as tolerated.
- If greater than 45 degree flexion contracture was present before surgery, use a static extension brace at night for 4-8 weeks.
- The patient must avoid forcible extension for 6-8 weeks.
- Lifting limitations
 - The patient must not lift more than one pound (~0.5 kg) during the first three post-operative months; and, thereafter, not more than five pounds (~2.25 kg) with the operated arm.

9. Poly Revision

9.1 Unlink Implant

- Remove both Humeral Screws using the Elbow Torque Driver (Fig. 9.1).
- Hyperflex the forearm to create a separation between Implants.
- Apply the tip of the Articulation Extractor between the Ulnar eye and the Humeral Bearing.
- Lever the Articulation Extractor to separate the articulation (Fig. 9.2.).

9.2 Remove Bearings

- Remove Ulnar Bearings.
 - Firmly grasp the Axle-Pin with a rongeur and pull it through the opposite Bearing to release the Ulnar Bearings. A second rongeur can be used to secure the opposing Ulnar Bearing (Fig. 9.3).



Fig. 9.1

Remove the screws with the Elbow Torque Driver.

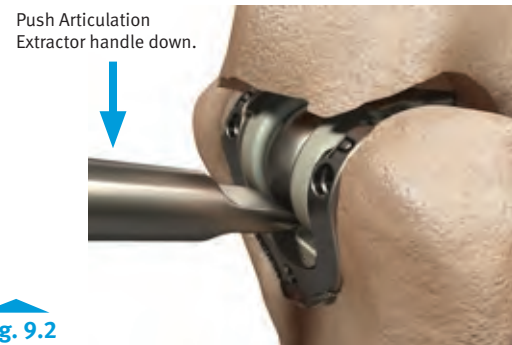

Fig. 9.2

Use Articulation Extractor to separate the implants.

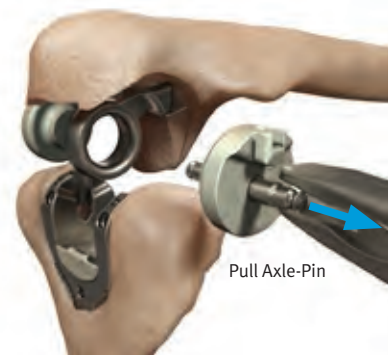

Fig. 9.3

Remove Ulnar Bearings using rongeurs.

Instruments



Articulation
Extractor
00-8401-092-00

Elbow
Torque Driver
00-8401-080-00

- Remove Humeral Bearing.
 - Use a rongeur to remove the Humeral Bearing by grasping the Bearing and rocking the rongeur fore or aft (Fig 9.4).
 - Confirm no fragments of the Bearing remain in the Implant.

9.3 Replace Humeral Bearing

- Place the appropriate size-matched Humeral Bearing into the Humeral Component using the Humeral Bearing Placement Tool (Fig. 9.5).
 - The Humeral Bearing will not be fully seated at this stage.
 - Only the “pilot cylinder” of the peg feature should be inserted into the hole in the base of the yoke of the Humeral Component.
- Position the Humeral Bearing Driver against the articulation surface of the Humeral Bearing.
- Carefully impact the Humeral Bearing Driver with a mallet to seat the Humeral Bearing (Fig. 9.6).
 - Confirm there are no gaps between the Humeral Bearing and the Humeral Component.

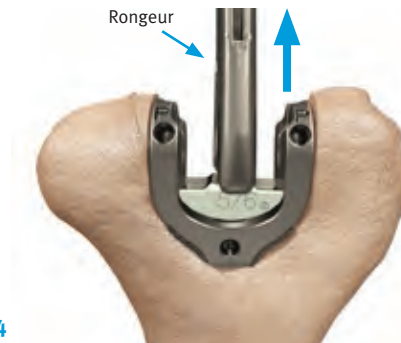

Fig. 9.4

Remove the Humeral Bearing using rongeurs.



Fig. 9.5

Use Humeral Bearing Placement Tool to place bearing.



Fig. 9.6

Position Driver, slide collar into Humeral slots, tap Driver to fully seat Bearing.

Instruments



Humeral
Bearing Driver
00-8401-078-00



Humeral Bearing
Placement Tool
00-8401-082-00

9.4 Replace Ulnar Bearings

- Load Ulnar Bearings and Axle-Pin as described on page 19.
- Attach the Bearing/Axle-Pin to the Ulnar Component.
 - Carefully place the Axle-Pin through the eye of the Ulnar Component in-situ (Fig. 9.7).
 - Squeeze the handles of the pre-loaded Ulnar Bearing Assembly Tool (UBAT) until hard-resistance is felt. No audible click will be heard (Fig. 9.8).
- Finish the procedure using the primary technique starting at Section 6: Final Assembly

Note: Bearing/Axle-Pin assembly is designed to be loose fitting to the Ulnar eye.

Note: Use caution to avoid contact between Axle-Pin and the Ulnar Component to avoid scratching the implant.



Fig. 9.7

Use UBAT to place Ulnar Bearings.



Fig. 9.8

Use UBAT to attach Ulnar Bearings.

Instruments



Ulnar Bearing
Assembly Tool
00-8401-081-00

SCRUB NURSE

Slide Hammer Assembly

A. Assemble Slide Hammer

- Place the Hammer on the shaft and lock in place by threading the nut onto the shaft.
- Thread the Implant Extractor Hook on the end of the shaft.

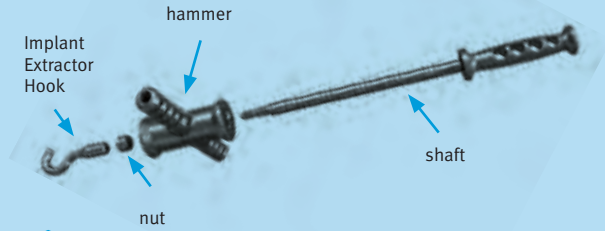

Fig. A

Assemble the Slide Hammer

10. Component Removal

TECHNIQUE TIP

6.5

If the Ulnar Component is well fixed, remove the cement from around the Implant as extensively as possible before attempting extraction.

10.1 Ulnar Component Removal

- Place the Implant Extractor Hook through the Ulnar eye (Fig. 10.1).
- Remove the Ulnar Component with the Slide Hammer.



Fig. 10.1

Extract Ulnar Implant.

10.2 Humeral Component Removal

Note: *If the Humeral Component is well fixed, remove the cement from around the implant as extensively as possible before attempting extraction.*

- Attach the size-matched Humeral Extractor Plate.
 - Insert the Humeral Extractor Screws through the openings in the Humeral Extractor Plate and into the Humeral Implant threaded holes (Fig. 10.2).
 - Lightly tighten the Screws using the Small Hex Screwdriver – no audible click will be heard.
- Place the Implant Extractor Hook under the Humeral Extractor Plate (Fig. 10.3).
- Remove the Humeral Component with the Slide Hammer.



Fig. 10.2

Attach Humeral Extractor Plate.



Fig. 10.3

Extract Humeral Implant.

Instruments



Humeral Extractor Plate
00-8401-059-05



Humeral Extractor Screws
00-8401-093-00



Small Hex Screw Driver
00-4812-035-00



Extractor Hook
00-8401-029-00



Slide Hammer
00-8401-009-00

DISCLAIMER:

This documentation is intended exclusively for physicians and is not intended for laypersons. Information on the products and procedures contained in this document is of a general nature and does not represent and does not constitute medical advice or recommendations. Because this information does not purport to constitute any diagnostic or therapeutic statement with regard to any individual medical case, each patient must be examined and advised individually, and this document does not replace the need for such examination and/or advise in whole or in part.

Please refer to the package inserts for important product information, including, but not limited to, indications, contraindications, warnings, precautions, and adverse effects.

Contact your Zimmer representative or visit us at www.zimmer.com

The CE mark is valid only if it is also printed on the product label.

